



**LED LIGHTING**  
we bring innovation and give inspiration

Yijia Industrial Park, Fuqian Road, Guanlan Town, Longhua, Shenzhen, Guangdong, China  
☎ +86 755 2809 3844  
☎ +86 755 2760 8651  
✉ info@signcomplex.com  
🌐 www.signcomplex.com

Av. Gral. Flores 2199 C.P.: 11800 - Montevideo, Uruguay  
☎ (598 2) 924 7080  
☎ (598 2) 924 7080 int. 104  
✉ mgi@mgi.com.uy  
🌐 www.mgi.com.uy

**2018V2**  
www.signcomplex.com

## About Signcomplex

Signcomplex Ltd., founded in 2006, is a state-level high-tech enterprise and TÜV ISO 9001:2015 certified and registered company. Currently there are over 1000 employees, and a fabrication area of more than 40,000 square meters. Our company has advanced LED luminaire manufacturing facilities such as auto SMT machines, reflow soldering machine, and professional test equipment, such as IP68 waterproof level test machine, integrating spheres, AOI tester, RoHS scanner, etc. We also have a professional trained QC team to ensure the quality of all the products. And all the products are CE certified as well as RoHS compliant, and some of the products are UL, FCC, Energy Star compliant. Signcomplex enjoys a high reputation as a LED luminaire supplier throughout Europe and the US.

Signcomplex devotes itself to developing new products with state-of-the-art technologies. Our R&D team with more than 100 people have abundant experience in industrial design, electronic driver, heat simulation analysis, optical lens design, light control system. Most of our products are self-designed with private moulds. We have more than 200 patents of shape design, utility model patents and software copyright. We monthly develop more than 2 new products and 10 customized products. All our designs fully follow UL and EU electrical safety standards. A customized design can be provided in 3 days tailored to customer's request.

Excellent Signcomplex LED luminaires have already provided inspiration for thousands of designers, architects and engineers all over the world. With our customer, we actively explore the ideas in architectural, residential, commercial, industrial lighting and special auxiliary lighting. We have already offered lots of LED lighting solutions to many famous brands, e.g., Marlboro, L'OREAL, Hilton, Four Seasons, Coca-Cola, McDonald's, Armani, The Body Shop, H&M, Cartier and Nissan, etc.

Our excellent sales and after-sales team are always at your service and will take good care of you, our valued customer.

## About MGI

En MGI hace más de dos décadas hemos apostado a brindar a nuestros clientes soluciones en el área de la ingeniería eléctrica. nuestros clientes soluciones en el área de la ingeniería eléctrica.

Comercializamos conocimiento, equipos eléctricos de alta tensión, media tensión y baja tensión, iluminación, herramientas, instrumentos y equipos para la generación de energía.

Brindamos soluciones en iluminación para el uso comercial, industrial, residencial y vial. Hemos incorporado profesionales altamente especializados en iluminación y proyectos.

Somos soluciones globales en protección contra descargas atmosféricas, generación de energía solar fotovoltaica, compensación de energía reactiva y Power Quality. Nuestra ventaja competitiva es nuestra capacidad técnica, nuestras marcas y nuestro stock. La más alta calidad de nuestras marcas y de nuestros servicios nos posicionaron como socios estratégicos.

# Index

## Strip

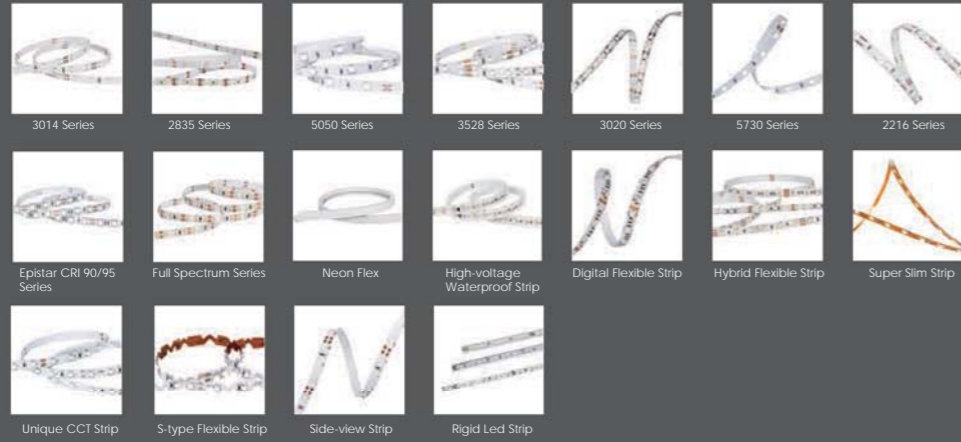

## LED Strip

1-54

## Panel light



## Commercial Lighting

55-256

## Emergency Light



## LED Tube



## Linear Light & Strip Light



## Ceiling Light & Downlight



## Track Light & PL Lamp



## Table Light



## Commercial Lighting

55-256

## High Bay light



## Flood light



## Tri-proof lamp



## Wall Pack & Area Light



## LED Corn Bulb



## Retrofit



## LED Controller and Power Repeater



## LED Controller and Power Repeater

333-348

## Aluminum bar



## Aluminum bar

349-354

## Limited Warranty

## Limited Warranty

# LED Strip

We are dedicated to providing high reliability and quality LED strip. Our company is one of the most reliable suppliers of LED strips, suitable for indoor and outdoor use, IP20, IP64, IP65, IP67, IP68 are available. Our strips can be widely used for furniture, advertising, business lighting, also for outdoor field lighting, auxiliary lighting or decoration lighting. Variety of brightness strips can be supplied to customers, including 140lm/w high energy-saving series, also providing kinds of professional aluminum profiles for customers for easy install.

**We have strict inspection standards for whole production, each strip quality is tested, followed 100% full inspection and 8-10 hours aging testing. LED BIN and color Ra are carried out under strict supervision in order to provide uniform illumination of strips.**

**No matter closet lighting or outdoor building decoration you can find quality strip here.**



# LED Strip



■ 3014 Series	.....	5-6
■ 2835 Series	.....	7-8
■ 5050 Series	.....	9-10
■ 3528 Series	.....	11-12
■ 3020 Series	.....	13-14
■ 5730 Series	.....	15-16
■ 2216 Series	.....	17-18
■ Epistar CRI 90/95 Series	.....	19-20
■ Full silicone extrusion Strip	.....	21-22
■ Full Spectrum Series	.....	23-24
■ Neon Flex	.....	25-32
■ High-voltage waterproof strip	.....	33-34
■ Digital Flexible strip	.....	35-36
■ Hybrid flexible strip	.....	37-38
■ Super slim strip (3.5mm width)	.....	41-42
■ Unique CCT strip	.....	43-44
■ S-type flexible strip	.....	45-46
■ Side-view strip	.....	47-48
■ Rigid LED strip	.....	49-54

## 3014 Series



Model	Leds/M	Watt/M	Input Voltage	Lumens/M	CRI	FPC Width mm	Color	IP Grade	Min Cut mm
SC-IE-X	60	7.2W/M	12/24V DC	760 650 600	80/90	8	W/NW/WW/R/G/B/Y	20/64/65/68	50/100
SC-IE2-X	120	14.4W/M	12/24V DC	1500 1320 1200	80/90	10	W/NW/WW/R/G/B/Y	20/64/65/68	25/50
SC-IE3-X	204	24.5W/M	12/24V DC	2100 1980 1540	80/90	10	W/NW/WW/R/G/B/Y	20/64	14.7/29.4

## 140lm/W series

Model	Leds/M	Watt/M	Input Voltage	Lumens/M	CRI	FPC Width mm	color	IP Grade	Min Cut mm
SC-IE-PX	64	5.8W/M	12/24V DC	810 800 740	80/90	8	W/NW/WW	20/64/65/68	62.5/125
SC-IE2-PX	128	11.5W/M	12/24V DC	1610 1590 1470	80/90	10	W/NW/WW	20/64/65/68	31.2/62.4
SC-IE3-PX	192	17.2W/M	12/24V DC	2410 2370 2200	80/90	10	W/NW/WW	20/64	20.8/41.6

## SDCM&lt;3 series

Model	Leds/M	Watt/M	Input Voltage	Lumens/M	CRI	FPC Width mm	color	IP Grade	Min Cut mm
SC-3014SD-XX	60	7.2W/M	12/24V DC	760 650 600	80	8	W/NW/WW	20/64/65/68	50/100
SC-3014SD2-XX	120	14.4W/M	12/24V DC	1520 1300 1200	80	10	W/NW/WW	20/64/65/68	25/50
SC-3014SD3-XX	204	24.5W/M	12/24V DC	2100 1980 1540	80	10	W/NW/WW	20/64	14.7/29.4

# 2835 Series



Model	Leds/M	Watt/M	Input Voltage	Lumens/M	CRI	FPC Width mm	Color	IP Grade	Min Cut mm
SC-IG1-X	30	7.2W/M	12/24V DC	710 660 620	80/90	8	W/NW/WW	20/64/65/68	100/166.6
SC-IG2-X	60	14.4W/M	12/24V DC	1380 1250 1230	80/90	10	W/NW/WW	20/64/65/68	50/100
SC-IG3-X	120	28.8W/M	12/24V DC	2760 2710 2390	80/90	10	W/NW/WW	20/64	25/50

## 140lm/W series

Model	Leds/M	Watt/M	Input Voltage	Lumens/M	CRI	FPC Width mm	color	IP Grade	Min Cut mm
SC-IG-PX	32	5.8W/M	12/24V DC	760 740 660	80/90	8	W/NW/WW	20/64/65/68	125/250
SC-IG2-PX	64	11.5W/M	12/24V DC	1530 1490 1330	80/90	10	W/NW/WW	20/64/65/68	62.5/125
SC-IG3-PX	120	21.6W/M	12/24V DC	2880 2800 2500	80/90	10	W/NW/WW	20/64	33.3/66.6

## SDCM<3 series

Model	Leds/M	Watt/M	Input Voltage	Lumens/M	CRI	FPC Width mm	color	IP Grade	Min Cut mm
SC-2835SD1-XX	30	7.2W/M	12/24V DC	590 580 560 540	80	8	W/NW/WW/SWW	20/64/65/68	100/166.6
SC-2835SD2-XX	60	14.4W/M	12/24V DC	1190 1160 1110 1080	80	10	W/NW/WW/SWW	20/64/65/68	50/100
SC-2835SD3-XX	120	28.8W/M	12/24V DC	2380 2320 2220 2160	80	10	W/NW/WW/SWW	20/64	25/50

## 170lm/W series

Model	Leds/M	Watt/M	Input Voltage	Lumens/M	CRI	FPC Width mm	color	IP Grade	Min Cut mm
SC-2835HE-PX	32	5.8W/M	12/24V DC	950 930 1020	80	8	W/NW/WW	20/64/65/68	125/250
SC-2835HE-PX2	64	11.5W/M	12/24V DC	1890 1880 2040	80	10	W/NW/WW	20/64/65/68	62.5/125
SC-2835HE-PX3	120	21.6W/M	12/24V DC	3610 3870 3870	80	10	W/NW/WW	20/64	33.3/66.6

## 5050 Series



Model	Leds/M	Watt/M	Input Voltage	Lumens/M	CRI	FPC Width mm	Color	IP Grade	Min Cut mm
SC-5050IA-X	30	7.2W/M	12/24V DC	510 480 450	70	10	W/NW/WW	20/64/65	100/200
SC-5050IB2-X	30	7.2W/M	12/24V DC	510 480 450	70	10	W/NW/WW	20/64/65/68	100/200
SC-5050IB-X	30	7.2W/M	12/24V DC	490 470 390	80/90	10	W/NW/WW/R/G/B/Y	20/64/65/68	100/200
SC-5050IP-X	30	7.2W/M	12/24V DC	650 640 600	80/90	10	W/NW/WW/R/G/B/Y	20/64/65/68	100/200
SC-5050IA-X2	60	14.4W/M	12/24V DC	1020 960 900	70	10	W/NW/WW	20/64/65	50/100
SC-5050IB2-X2	60	14.4W/M	12/24V DC	1020 960 900	70	10	W/NW/WW	20/64/65/68	50/100
SC-5050IB-X2	60	14.4W/M	12/24V DC	980 940 780	80/90	10	W/NW/WW/R/G/B/Y	20/64/65/68	50/100
SC-5050IP-X2	60	14.4W/M	12/24V DC	1400 1380 1260	80/90	10	W/NW/WW/R/G/B/Y	20/64/65/68	50/100

## RGB Series

Model	Leds/M	Watt/M	Input Voltage	FPC Width mm	Color	IP Grade	Min Cut mm
SC-IB-RGB	30	7.2W/M	12/24V DC	10	RGB	20/64/65/68	100/200
SC-IC-RGB	30	7.2W/M	12/24V DC	10	RGB	20/64/65/68	100/200
SC-5050IP-RGB	30	7.2W/M	12/24V DC	10	RGB	20/64/65/68	100/200
SC-IB-RGB2	60	14.4W/M	12/24V DC	10	RGB	20/64/65/68	50/100
SC-IC-RGB2	60	14.4W/M	12/24V DC	10	RGB	20/64/65/68	50/100
SC-5050IP-RGB2	60	14.4W/M	12/24V DC	10	RGB	20/64/65/68	50/100



# 3528 Series



Model	Leds/M	Watt/M	Input Voltage	Lumens/M	CRI	FPC Width mm	Color	IP Grade	Min Cut mm
SC-IA-X	60	4.8W/M	12/24V DC	380 370 360	70	8	W/NW/WW/R/G/B/Y	20/64/65	50/100
SC-IB2-X	60	4.8W/M	12/24V DC	380 370 360	70	8	W/NW/WW/R/G/B/Y	20/64/65/68	50/100
SC-IB-X	60	4.8W/M	12/24V DC	390 360 350	80/90	8	W/NW/WW/R/G/B/Y	20/64/65/68	50/100
SC-IC-X	60	4.8W/M	12/24V DC	420 400 390	80/90	8	W/NW/WW/R/G/B/Y UV/P	20/64/65/68	50/100
SC-IB2-X2	120	9.6W/M	12/24V DC	760 740 720	70	8	W/NW/WW/R/G/B/Y	20/64/65/68	25/50
SC-IB-X2	120	9.6W/M	12/24V DC	780 690 680	80/90	8	W/NW/WW/R/G/B/Y	20/64/65/68	25/50
SC-IC-X2	120	9.6W/M	12/24V DC	850 810 790	80/90	8	W/NW/WW/R/G/B/Y UV/P	20/64/65/68	25/50
SC-IB-X4	240	19.2W/M	12/24V DC	1565 1490 1455	80/90	10	W/NW/WW/R/G/B/Y	20/64	12.5/25
SC-IC-X4	240	19.2W/M	12/24V DC	1700 1620 1580	80/90	10	W/NW/WW/R/G/B/Y	20/64	12.5/25
SC-HID-X	78	12.4W/M	12/24V DC	700 650 550	80/90	8	W/NW/WW/R	20/64/65/68	38.46/76.9
SC-XID-X	240	19.2W/M	12/24V DC	1700 1560 1400	80/90	16	W/NW/WW/R	20/65	25/50

## 12/24V Universal Strip

Model	Leds/M	Watt/M	Input Voltage	Lumens/M	CRI	FPC Width mm	Color	IP Grade	Min Cut mm
SC-DC-XX	60	4.8W/M	12/24V DC	390 330 320	80	10	W/NW/WW	20	50/100

## Wide Beam Angle Strip

Model	Leds/M	Watt/M	Input Voltage	Lumens/M	CRI	FPC Width mm	Color	IP Grade	Min Cut mm
SC-3528RH-XX	60	4.8W/M	12/24V DC	460 455 450	80	8	W/NW/WW	20	25/50
SC-3528RH-XX2	120	9.6W/M	12/24V DC	920 910 900	80	8	W/NW/WW	20	27.53



# 3020 Series



Model	Leds/M	Watt/M	Input Voltage	Lumens/M	CRI	FPC Width mm	Color	IP Grade	Min Cut mm
SC-BID-X	120	19.2W/M	12/24V DC	1220 1090 850	80/90	10	W/NW/WW	20/64/65/68	25/50

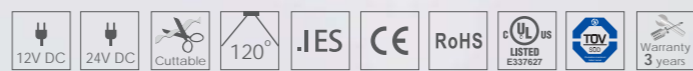

# 5730 Series



Model	Leds/M	Watt/M	Input Voltage	Lumens/M	CRI	FPC Width mm	Color	IP Grade	Min Cut mm
SC-IF-X	36	21.6W/M	24V DC	1920 1760 1650	80/90	10	W/NW/WW	20/64	166.66

## 2216 Series

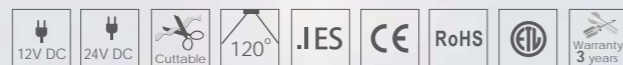

Model	Leds/M	Watt/M	Input Voltage	Lumens/M	CRI	Beam angle (degree)	Color	IP Grade	Min Cut mm
SC-2216IB-XX	120	9.6	12/24 VDC	830   720   790	90	120	W/NW/WW	20/64/65/68	25/50 12.5/25
SC-2216IB-XX2	240	19.2	12/24 VDC	1630   1400   1530	90	120	W/NW/WW	20/64/65/68	12.45/24.99

## Epistar CRI 90/95 Strip



## 5050

Model	Leds/M	Watt/M	Input Voltage	Lumens/M	CRI	Beam angle (degree)	Color	IP Grade	Min Cut mm
SC-EP5050-X-12/24	30	7.2	12/24V DC	675 660 600	90/95	120	W/NW/WW	20/64/65/68	100/166.7
SC-EP5050-X-95-12/24	30	7.2	12/24V DC	660 640 615	90/95	120	W/NW/WW	20/64/65/68	100/166.7
SC-EP5050-X2-12/24	60	14.4	12/24V DC	1350 1320 1200	90/95	120	W/NW/WW	20/64/65/68	50/100
SC-EP5050-X2-95-12/24	60	14.4	12/24V DC	1320 1290 1230	90/95	120	W/NW/WW	20/64/65/68	50/100

## 3528

Model	Leds/M	Watt/M	Input Voltage	Lumens/M	CRI	Beam angle (degree)	Color	IP Grade	Min Cut mm
SC-EP3528-X-12/24	60	4.8	12/24V DC	520 500 450	90/95	120	W/NW/WW	20/64/65/68	50/100
SC-EP3528-X-95-12/24	60	4.8	12/24V DC	470 450 410	90/95	120	W/NW/WW	20/64/65/68	50/100
SC-EP3528-X2-12/24	120	9.6	12/24V DC	1040 1000 900	90/95	120	W/NW/WW	20/64/65/68	25/50
SC-EP3528-X2-95-12/24	120	9.6	12/24V DC	940 900 820	90/95	120	W/NW/WW	20/64/65/68	25/50

## 2835

Model	Leds/M	Watt/M	Input Voltage	Lumens/M	CRI	Beam angle (degree)	Color	IP Grade	Min Cut mm
SC-EP2835-X-12/24	30	7.2	12/24V DC	670 660 630	90/95	120	W/NW/WW	20/64/65/68	50/100
SC-EP2835-X-95-12/24	30	7.2	12/24V DC	620 600 540	90/95	120	W/NW/WW	20/64/65/68	50/100
SC-EP2835-X2-12/24	60	14.4	12/24V DC	1350 1320 1260	90/95	120	W/NW/WW	20/64/65/68	25/50
SC-EP2835-X2-95-12/24	60	14.4	12/24V DC	1240 1200 1080	90/95	120	W/NW/WW	20/64/65/68	25/50
SC-EP2835-X3-12/24	120	28.8	12/24V DC	2700 2640 2520	90/95	120	W/NW/WW	20/64	12.5/25
SC-EP2835-X3-95-12/24	120	28.8	12/24V DC	2480 2400 2160	90/95	120	W/NW/WW	20/64	12.5/25

## Full silicone extrusion Strip



### SC-AT8/10

- Full silicone extrusion, anti-corrosion, anti-UV, and it can be used in swimming pool;
- Outlet wire with full silicone, corrosion resistance;
- Optional LEDs 3528, 2835, 5050, 3014, etc;
- Full silicon wire for better connection;
- Large structure (10\*5mm; 12\*6mm), IP65 grade;
- Mounting clips installation;
- 50-100K CCT shift, better to control color temperature.



## Full Spectrum Series



### 3528

Model	Leds/M	Watt/M	Input Voltage	Lumens/M	CRI	Beam angle (degree)	Color	IP Grade	Min Cut mm
SC-TM-XX	60	4.8	12/24V DC	283 357 300 261	95	120	W/NW/WW	20/64/65/68	50/100
SC-TM-XX2	120	9.6	12/24V DC	560 700 596 515	95	120	W/NW/WW	20/64/65/68	25/50

### 2835

Model	Leds/M	Watt/M	Input Voltage	Lumens/M	CRI	Beam angle (degree)	Color	IP Grade	Min Cut mm
SC-2835TM-XX	30	7.2	12/24V DC	500 490 440 420	97	120	W/NW/WW/SWW	20/64/65/68	100/166.6
SC-2835TM-XX2	60	14.4	12/24V DC	1010 980 880 840	97	120	W/NW/WW/SWW	20/64/65/68	50/100
SC-2835TM-XX3	120	28.8	12/24V DC	2020 1960 1760 1680	97	120	W/NW/WW/SWW	20/64	25/50

### 2216

Model	Leds/M	Watt/M	Input Voltage	Lumens/M	CRI	Beam angle (degree)	Color	IP Grade	Min Cut mm
SC-2216TM-12D-XX	120	9.6	12/24V DC	700 650 580	95	120	W/NW/WW	20	25/50
SC-2216TM-24D-XX	240	19.2	12/24V DC	1380 1250 1120	95	120	W/NW/WW	20	12.5/25
SC-2216TM-28D-XX	280	19.2	12/24V DC	1650 1560 1380	95	120	W/NW/WW	20	14.3/25
SC-2216TM-30D-XX	300	24	12/24V DC	1750 1660 1450	95	120	W/NW/WW	20	20/20

# Neon Flex

## 5050

Model	Leds/M	Watt/M	Input Voltage	Lumens/M	CRI	FPC Width mm	Color	IP Grade	Min. Cut mm
SC-ESID-X-24	60	14.4	24V DC	410 380 340	80	10	W/NW/WW R/G/B/Y/RGB	67	100
SC-ESID02-X-24	60	14.4	24V DC	410 380 340	80	10	W/NW/WW R/G/B/Y/RGB	67	100
SC-ESID-X-220	60	15	220-240 AC	410 380 340	80	10	W/NW/WW/G/B	65	333.3
SC-ESID5050-120V-X-2388	60	14.6	120 AC	260 250 240	80	12	W/NW/WW/R/G/B/O	65	333.3



Accessories:





# Neon Flex

## Super Mini version-Side view



3014

Model	Leds/M	Watt/M	Input Voltage	Lumens/M	CRI	FPC Width mm	Color	IP Grade	Min Cut mm
SC-ESID-X-M-24	182	12.5	24V DC	510 460 400	80	8	W/NW/WW R/G/B/Y/O	67	38.5
SC-ESID-W/WW-M-24V	240	9.6	24V DC	408 375	80	8	W/WW	67	50

Accessories:



# IP67 Mini Neon Strip

## Top View Version

Model	Leds/M	Watt/M	Input Voltage	Lumens/M	CRI	FPC Width mm	Color	IP Grade	Min. Cut mm
SC-TSID-M-24	182	12.5	24V DC	527 707 699	80	8	W/NW/WW R/G/B/Y	67	38.5
SC-TSID-W/WW-M-24V	240	9.6	24V DC	450 410	80	8	W/WW	67	50



Accessories:

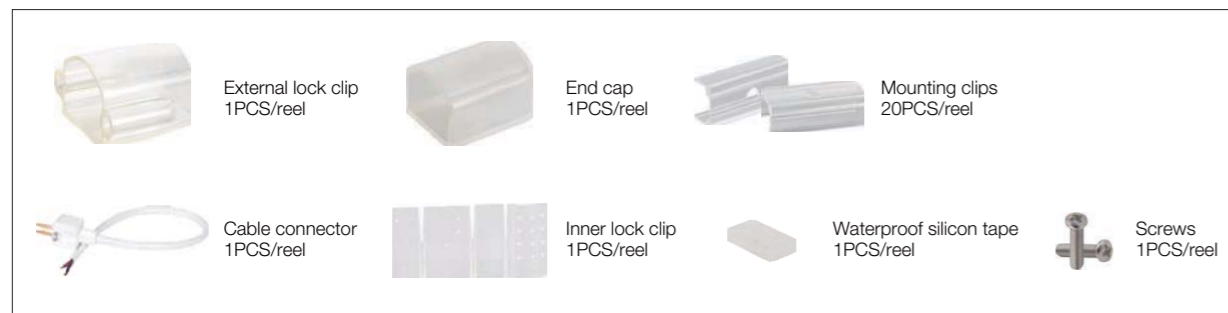

# IP67 Silica Ge Neon Strip

## Side View Version



3014

Model	Leds/M	Watt/M	Input Voltage	Lumens/M	CRI	FPC Width mm	Color	IP Grade	Min Cut mm
SC-SW4-X-24V	126	8.5	24V DC	176 180 167	80	8	W/NW/WW R/G/B/Y	67	55
SC-TSE-X-24V	126	8.5	24V DC	624 604 547	80	8	W/NW/WW R/G/B/Y	67	55
SC-SSE-X-24V	126	8.5	24V DC	305 340 260	80	8	W/NW/WW R/G/B/Y	67	55



## High-voltage waterproof strip



### 5050

Model	Leds/M	Watt/M	Input Voltage	Lumens/M	CRI	FPC Width mm	Color	IP Grade	Min Cut mm
SC-HV5050-X-220	60	6.6	220-240V AC	630 560 500	80	12	W/NW/WW R/G/B/Y/O	65	333.3
SC-HV5050-120V-X-2388	60	14.6	120V AC	1200 1100 1000	80	12	W/NW/WW R/G/B/Y/O	65	166.67

# Digital Flexible strip



## 5050(built-in IC)

Model	Leds/M	Watt/M	Input Voltage	FPC Width mm	Color	IP Grade	Min Cut mm
SC-DID-RGB2812-30A	30	9.6	5V DC	10	RGB	20/64/65/68	33.33
SC-DID-RGB2812-60A	60	14.4	5V DC	10	RGB	20/64/65/68	16.66

## Hybrid flexible strip



### 5225

Model	Leds/M	Watt/M	Input Voltage	CRI	FPC Width mm	Color	IP Grade	Min Cut mm
SC-YID3-W+WW-12	60 (2 in 1)	28.8	12V DC	80/90	10	2 IN 1 (W+WW)	20/64	50

### 5050

Model	Leds/M	Watt/M	Input Voltage	FPC Width mm	Color	IP Grade	Min Cut mm
SC-OID2	30RGB+30 single	14.4	12V/24V DC	12	RGB+SINGLE COLOR	20/64/65/68	50/100
SC-OID3	20RGB+40 single	14.4	24V/12V DC	12	RGB+SINGLE COLOR	20/64/65/68	50/100
SC-OID4	60 ( 4 in 1)	19.2	12V/24V DC	10	4 IN 1 (RGB+SIGNAL COLOR)	20/64	50/100
SC-OID5	60 ( 5 in 1)	4.8/28.8	12V/24V DC	12	5 IN 1 (RGB+SIGNAL COLOR)	20/64	50/100

### 3528

Model	Leds/M	Watt/M	Input Voltage	CRI	FPC Width mm	Color	IP Grade	Min Cut mm
SC-YID-1-A	120	9.6	12V DC	80/90	8	w+ww	20/64/65/68	25
SC-YID-W+WW-12	120	9.6	12V DC	80/90	10	w+ww	20/64/65/68	25
SC-YID2-W+WW	60 (2 in 1)	9.6	12V DC	70/90	10	2 IN 1 (W+WW)	20/64/65/68	50



## Super slim strip (3.5mm width)



### 3020

Model	Leds/M	Watt/M	Input Voltage	Lumens/M	CRI	FPC Width mm	Color	IP Grade	Min Cut mm
SC-ID35-X	78	12.4	12V DC	990 980 940	80/90	3.5	W/NW/WW	20	38.5

### 3014

Model	Leds/M	Watt/M	Input Voltage	Lumens/M	CRI	FPC Width mm	Color	IP Grade	Min Cut mm
SC-IE35-90-X	90	11	12V DC	990 980 940	80/90	3.5	W/NW/WW R/G/B/Y/O	20	33.33
SC-IE35-120-X	120	14.4	12V DC	1200 1150 1100	80/90	3.5	W/NW/WW R/G/B/Y/O	20	25



# Unique CCT strip

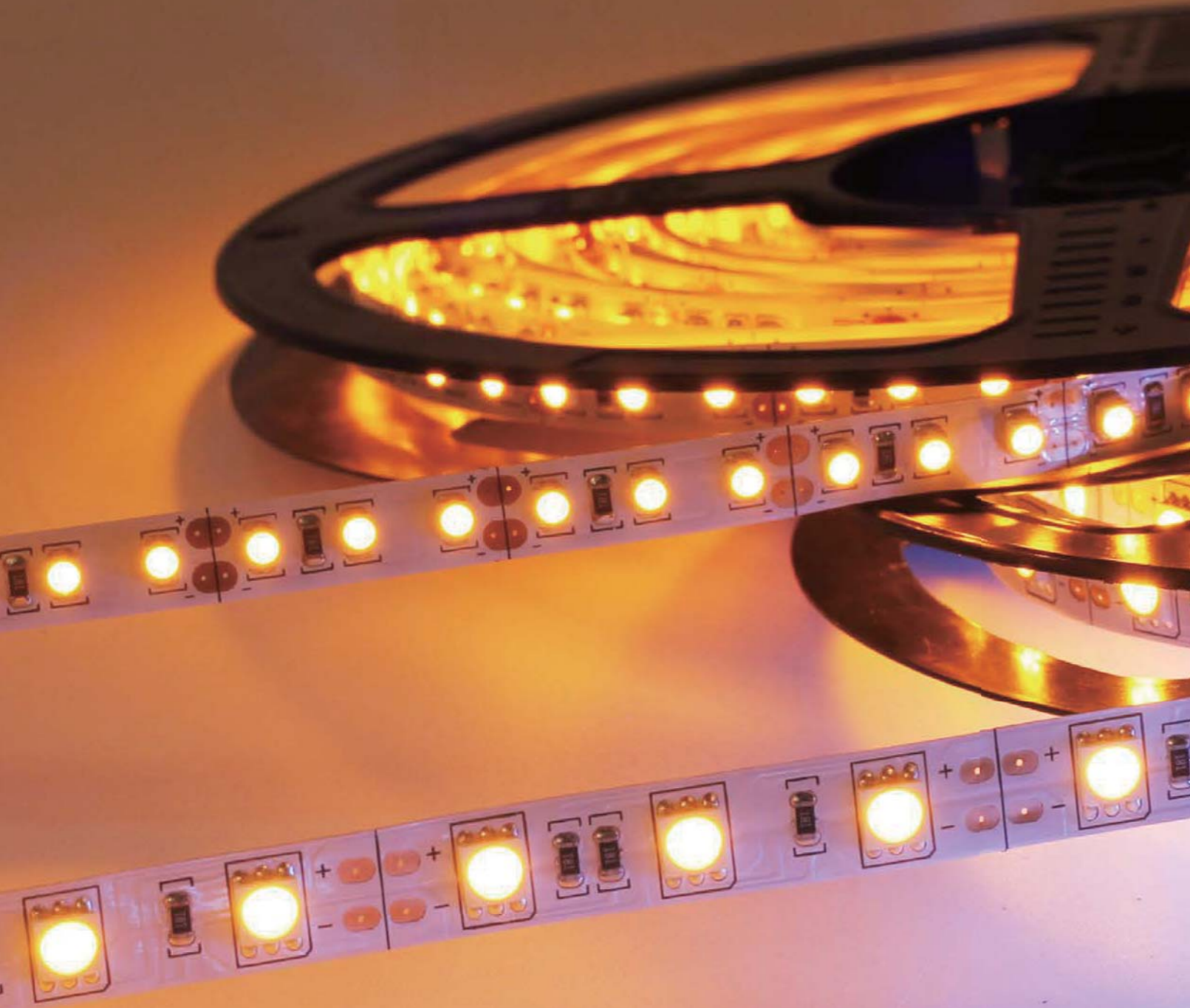

## 3528

Model	Leds/M	Watt/M	Input Voltage	Color	Lumens/M	FPC Width mm	IP Grade	Min Cut mm
SC-IC-IB	60	4.8	12/24V DC	Ice blue	250	8	20/64/65/68	50/100
SC-IC-IB2	120	9.6	12/24V DC	Ice blue	510	8	20/64/65/68	25/50
SC-IC-GY	60	4.8	12/24V DC	Golden yellow	310	8	20/64/65/68	50/100
SC-IC-GY2	120	9.6	12/24V DC	Golden yellow	630	8	20/64/65/68	25/50

## 5050

Model	Leds/M	Watt/M	Input Voltage	Color	Lumens/M	FPC Width mm	IP Grade	Min Cut mm
SC-5050ID-IB	30	7.2	12/24V DC	Ice blue	430	10	20/64/65/68	100/200
SC-5050ID-IB2	60	14.4	12/24V DC	Ice blue	850	10	20/64/65/68	50/100
SC-5050ID-GY	30	7.2	12/24V DC	Golden yellow	500	10	20/64/65/68	100/200
SC-5050ID-GY2	60	14.4	12/24V DC	Golden yellow	1010	10	20/64/65/68	50/100

# S-type flexible strip



## 3528

Model	Leds/M	Watt/M	Input Voltage	Lumens/M	CRI	FPC Width mm	Color	IP Grade	Min Cut mm
SC-IS-X-8mm	60	4.8	12V DC	420 400 390	80/90	8	W/NW/WW R/G/B/Y/O	20	50
SC-IS-X-6mm	72	5.76	12V DC	500 480 460	80/90	6	W/NW/WW R/G/B/Y/O	20	41.66

## Side-view strip

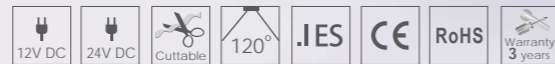

## 3014

Model	Leds/M	Watt/M	Input Voltage	Lumens/M	CRI	FPC Width mm	Color	IP Grade	Min Cut mm
SC-SID-3014-X	60	4.8	12/24V DC	720   660   600	80	8	W/NW/WW	20/65	50/100

# Rigid LED strip



## 3528

Model	Leds/M	Watt/M	Input Voltage	Lumens/M	CRI	FPC Width mm	Color	IP Grade	Min Cut mm
SC-SS-X	30	2.4	12/24V DC	200 180 160	80/90	8	W/NW/WW R/G/B/Y	20	100/200
SC-WLS30-X	30	3	12/24V DC	190 170 150	80/90	8	W/NW/WW R/G/B/Y/RGB	65	100/200
SC-WLS60-X	60	6	12/24V DC	380 340 300	80/90	8	W/NW/WW R/G/B/Y/RGB	65	50/100

## 5050

Model	Leds/M	Watt/M	Input Voltage	Lumens/M	CRI	FPC Width mm	Color	IP Grade	Min Cut mm
SC-ASS30-X	30	7.2	12/24V DC	500 450 400	80	10	W/NW/WW R/G/B/Y/RGB	65	100/200
SC-ASS60-X	60	14.4	12/24V DC	1000 900 800	80/90	10	W/NW/WW R/G/B/Y/RGB	65	50/100
SC-SS-RGB	30	7.2	12/24V DC	500 450 400	80	10	RGB	20	50/100

## 2835

Model	Leds/M	Watt/M	Input Voltage	Lumens/M	CRI	FPC Width mm	color	IP Grade	Min Cut mm
SC-WLS30-M-W	30	7.2	12/24V DC	720 690 590	80/90	8	W/NW/WW	20	100/200
SC-WLS60-M-W	60	14.4	12/24V DC	1440 1380 1180	80/90	8	W/NW/WW	20	50/100

# 2835 / 4014 Seamless Lightbar



ARK6 Series



ARK7 Series

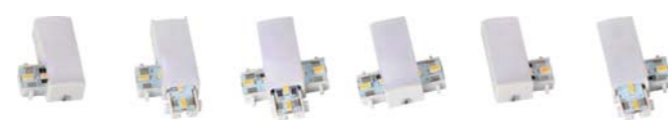

Model	Leds/M	Watt/M	Input Voltage	Lumens/M	CRI	Length mm	Color	IP Grade	Rated Current A
SC-ARK6-512-12V 30	30	7.2	12V DC	716 671 605	80/90	512	W/NW/WW	20	0.6
SC-ARK7-512-12V 84	84	7.56	12V DC	920 870 820	80/90	512	W/NW/WW	20	0.63

## IP65 Gables Lightbar

2835

Model	Leds/M	Watt/M	Input Voltage	Lumens/M	CRI	Length m	Color	IP Grade	Rated Current A
SC-WHL	120	10.8	24V DC	817 788 787	80/90	1	W/NW/WW	65	0.45



# Commercial Lighting

How can attract or even fascinate your customers with the products? Maybe you hope that customers entering into your restaurant sit down, order a coffee and quietly enjoy the life. Does your lighting atmosphere highlight your brand concept? Do you still use traditional CFL, halogen lamp, metal halide ?

**Its time to replace them with LED lamp. LED is solid light source, UV free, mercury free, and it is healthy and green lighting; at the same time it is more energy-saving, up to 85%.**

Signcomplex commercial lighting products are designed based on scene and mood lighting, different light efficiency, maximum up to 120lm/W, can meet general illuminance requirement. CCT 3000K,4000K,5000K,6000K, and 2700K(customized), minimum CRI >80, maximum 95. No matter glorious hotel or warm and sweet coffee shop, you can find suitable lamp from Signcomplex.

**Since 2006, Signcomplex supply thousands of our products to brand company like Louis Vuitton, Burberry, Sheraton, Four-Seasons, Marriott, Marlboro, NIKE, Walmart etc, and Signcomplex is the vendor of Schneider, Simon, SLV, Philips and Electrolux.**



# LED Panel Light



■ LED Troffer Series .....	59-64
■ X Series Square Panel Light .....	65-70
■ R Series Square Panel Light .....	71-76
■ K Series <small>Color temperature and brightness adjustable</small> .....	77-78
■ Narrow frame Panel series .....	79-80
■ LED Slim Panel Light .....	87-94
■ Waterproof Round Panel Light .....	95-96
■ FLOAT Suspending Panel Light .....	97-100
■ RGB Series .....	101-102
■ IP65 Waterproof Panel Light .....	103-104
■ LED Light Box .....	105-106
■ Dimmable Panel Light .....	107-109



white housing,RAL9003 aluminum frame and aluminum PCB plate makes excellent heat dissipation performance



PC cover ,120 degree high temperature resistant

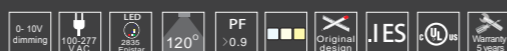

Size:(mm/inch) 2'2 feet 30W/40W

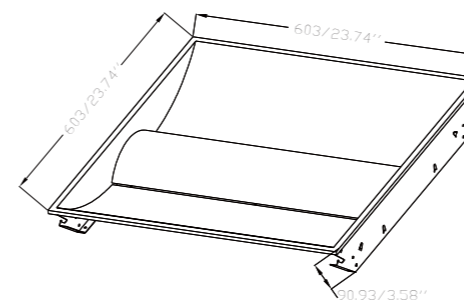

Model number	CCT	Light output (±10%/lm)	CRI
100LM/W			
SC-GLM-040-AW-6060S-01C	5000k	4200	>80
SC-GLM-040-AW-6060S-01N	4000K	4100	>80
SC-GLM-040-AW-6060S-01W	3000K	4040	>80
SC-GLM-050-AW-6012S-01C	5000k	5200	>80
SC-GLM-050-AW-6012S-01N	4000K	5100	>80
SC-GLM-050-AW-6012S-01W	3000K	5000	>80

Size:(mm/inch) 2'4 feet 40W/50W



Model number	CCT	Light output (±10%/lm)	CRI
125LM/W			
SC-GLM-030-AW-6060H-01C	5000k	3810	>80
SC-GLM-030-AW-6060H-01N	4000K	3750	>80
SC-GLM-030-AW-6060H-01W	3000K	3720	>80
SC-GLM-040-AW-6060H-01C	5000k	5200	>80
SC-GLM-040-AW-6060H-01N	4000K	5080	>80
SC-GLM-040-AW-6060H-01W	3000K	5040	>80
SC-GLM-040-AW-6012H-01C	5000k	5080	>80
SC-GLM-040-AW-6012H-01N	4000K	5040	>80
SC-GLM-040-AW-6012H-01W	3000K	5000	>80
SC-GLM-050-AW-6012H-01C	5000k	6350	>80
SC-GLM-050-AW-6012H-01N	4000K	6300	>80
SC-GLM-050-AW-6012H-01W	3000K	6250	>80

# LED Troffer Series



- Less cost of maintenance, Easy to install or replace fluorescent tubes.
- 40%~50% energy saving effect by **SMD LED**
- 30,000 hours life time

# LED Troffer Series

Industrial Area / Office Building / Ground Floor / Calculation surface 1 / Isolines/Horizontal illuminance  
**Calculation surface 1 / Isolines/Horizontal illuminance**

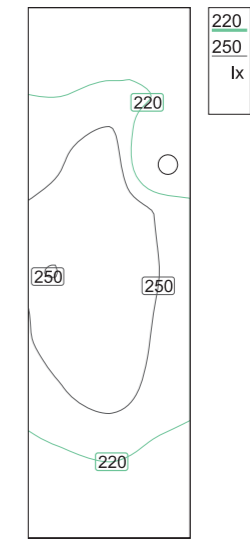
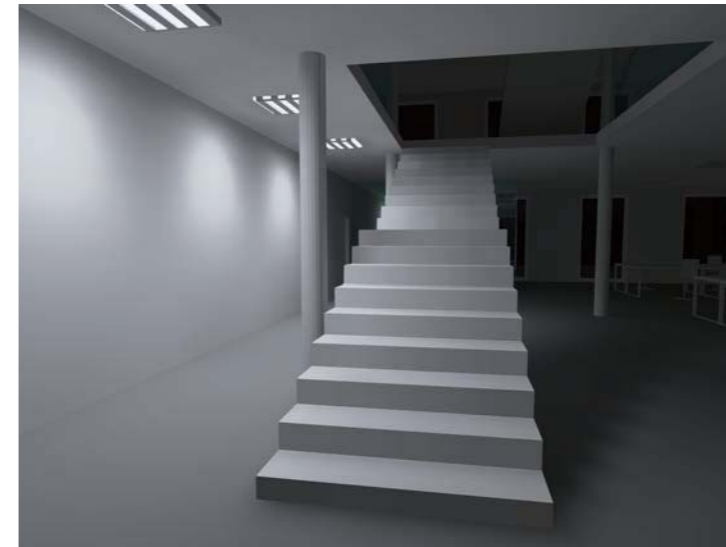

Scale: 1 : 50  
 Horizontal illuminance (Grid)  
 Average: 226 lx, Min: 148 lx, Max: 268 lx, Min/average: 0.655, Min/max: 0.552, Points: 3 x 9 (Relevant: all)

Industrial Area / Office Building / Ground Floor / Calculation surface 2 / Isolines/Horizontal illuminance  
**Calculation surface 2 / Isolines/Horizontal illuminance**

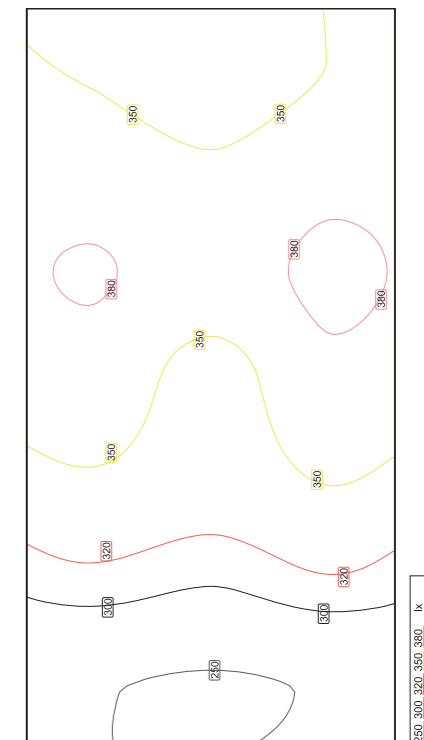

Scale: 1 : 10  
 Horizontal illuminance (Grid)  
 Average: 336 lx, Min: 245 lx, Max: 385 lx, Min/average: 0.729, Min/max: 0.636, Points: 7 x 3 (Relevant: all)

## LED Troffer Series



# X Series Panel Light (UL Approved) 2\*2 feet / 2\*4 feet / 1\*4 feet 100lm/w

white housing,RAL9003.  
6063 aluminum frame.  
super slim 8.6mm thickness.



Use reflective sheeting and aluminum back cover to prevent light leaking.

3 mm PMMA thickness light guide plate, PS diffuser panel with high light transmittance.



4014 SMD LED chip, high luminous efficacy with reliable quality, more than 50,000 hours life time.



LED driver: isolated constant current design, Low heat, and high efficiency up to 85%,PF>0.95.

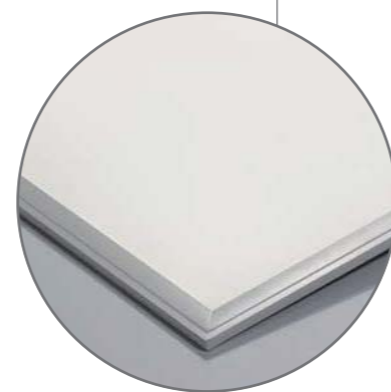

Size:(in.) 2x2 feet

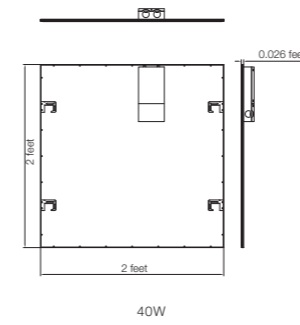

Size:(in.) 1x4 feet

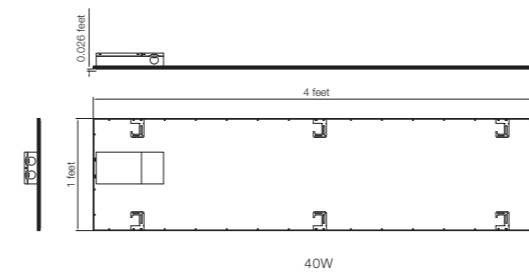

Size:(in.) 2x4 feet



Size:(in.) 2x4 feet

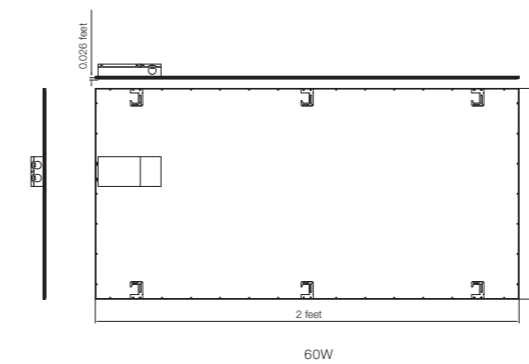

Model number	CCT	Light output (±10%)lm	CRI
SC-PSCAWCE6060-X40W-01	5000K	4040	>80
SC-PSCAWNE6060-X40W-01	4500K	4080	>80
SC-PSCAWNE6060-X40W-01	4000K	4080	>80
SC-PSCAWWE6060-X40W-01	3500K	4000	>80
SC-PSCAWWE6060-X40W-01	3000K	4000	>80
SC-PSCAWWE6060-X40W-01	2700K	4000	>80

Model number	CCT	Light output (±10%)lm	CRI
SC-PSCAWCE3012-X40W-01	5000K	4040	>80
SC-PSCAWNE3012-X40W-01	4500K	4080	>80
SC-PSCAWNE3012-X40W-01	4000K	4080	>80
SC-PSCAWWE3012-X40W-01	3500K	4000	>80
SC-PSCAWWE3012-X40W-01	3000K	4000	>80
SC-PSCAWWE3012-X40W-01	2700K	4000	>80

Model number	CCT	Light output (±10%)lm	CRI
SC-PSCAWCE6012-X50W-01	5000K	5050	>80
SC-PSCAWNE6012-X50W-01	4500K	5100	>80
SC-PSCAWNE6012-X50W-01	4000K	5100	>80
SC-PSCAWWE6012-X50W-01	3500K	5000	>80
SC-PSCAWWE6012-X50W-01	3000K	5000	>80
SC-PSCAWWE6012-X50W-01	2700K	5000	>80

Model number	CCT	Light output (±10%)lm	CRI
SC-PSCAWCE6012-X60W-01	5000K	6060	>80
SC-PSCAWNE6012-X60W-01	4500K	6120	>80
SC-PSCAWNE6012-X60W-01	4000K	6120	>80
SC-PSCAWWE6012-X60W-01	3500K	6000	>80
SC-PSCAWWE6012-X60W-01	3000K	6000	>80
SC-PSCAWWE6012-X60W-01	2700K	6000	>80



# X Series Panel Light (UL Approved) 2\*2 feet / 2\*4 feet / 1\*4 feet 125lm/w

white housing,RAL9003.  
6063 aluminum frame.  
super slim 8.6mm thickness.



Use reflective sheeting and aluminum back cover to prevent light leaking.

3 mm PMMA thickness light guide plate, PS diffuser panel with high light transmittance.



4014 SMD LED chip, high luminous efficacy with reliable quality, more than 50,000 hours life time.



LED driver: isolated constant current design, Low heat, and high efficiency up to 85%,PF>0.95.



Size:(in.) 2x2 feet

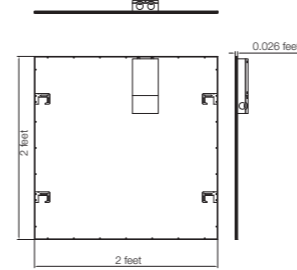

20W / 25W / 30W / 40W

Size:(in.) 1x4 feet

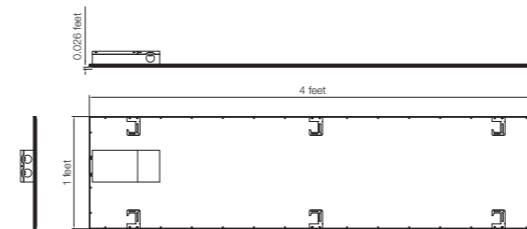

20W / 30W / 40W

Size:(in.) 2x4 feet

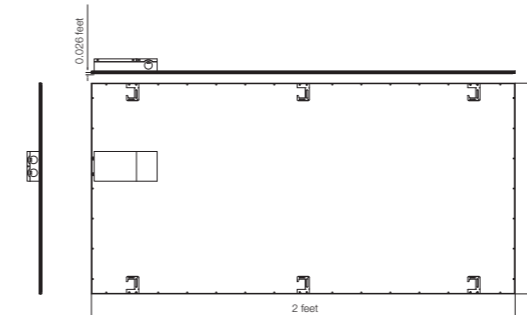

30W / 35W / 40W / 50W / 60W

Model number	CCT	Light output (±10%)lm	CRI
SC-PSCAWCE6060-H-X20W-01	5000K	2520	>80
SC-PSCAWNE6060-H-X20W-01	4500K	2540	>80
SC-PSCAWNE6060-H-X20W-01	4000K	2540	>80
SC-PSCAWWE6060-H-X20W-01	3500K	2500	>80
SC-PSCAWWE6060-H-X20W-01	3000K	2500	>80
SC-PSCAWWE6060-H-X20W-01	2700K	2500	>80
SC-PSCAWCE6060-H-X25W-01	5000K	3150	>80
SC-PSCAWNE6060-H-X25W-01	4500K	3175	>80
SC-PSCAWNE6060-H-X25W-01	4000K	3175	>80
SC-PSCAWWE6060-H-X25W-01	3500K	3125	>80
SC-PSCAWWE6060-H-X25W-01	3000K	3125	>80
SC-PSCAWWE6060-H-X25W-01	2700K	3125	>80
SC-PSCAWCE6060-H-X30W-01	5000K	3780	>80
SC-PSCAWNE6060-H-X30W-01	4500K	3810	>80
SC-PSCAWNE6060-H-X30W-01	4000K	3810	>80
SC-PSCAWWE6060-H-X30W-01	3500K	3750	>80
SC-PSCAWWE6060-H-X30W-01	3000K	3750	>80
SC-PSCAWWE6060-H-X30W-01	2700K	3750	>80
SC-PSCAWCE6060-H-X40W-01	5000K	5040	>80
SC-PSCAWNE6060-H-X40W-01	4500K	5080	>80
SC-PSCAWNE6060-H-X40W-01	4000K	5080	>80
SC-PSCAWWE6060-H-X40W-01	3500K	5000	>80
SC-PSCAWWE6060-H-X40W-01	3000K	5000	>80
SC-PSCAWWE6060-H-X40W-01	2700K	5000	>80
SC-PSCAWCE3012-H-X20W-01	5000K	2520	>80
SC-PSCAWNE3012-H-X20W-01	4500K	2540	>80
SC-PSCAWNE3012-H-X20W-01	4000K	2540	>80
SC-PSCAWWE3012-H-X20W-01	3500K	2500	>80
SC-PSCAWWE3012-H-X20W-01	3000K	2500	>80
SC-PSCAWWE3012-H-X20W-01	2700K	2500	>80
SC-PSCAWCE3012-H-X30W-01	5000K	3780	>80
SC-PSCAWNE3012-H-X30W-01	4500K	3810	>80
SC-PSCAWNE3012-H-X30W-01	4000K	3810	>80
SC-PSCAWWE3012-H-X30W-01	3500K	3750	>80
SC-PSCAWWE3012-H-X30W-01	3000K	3750	>80
SC-PSCAWWE3012-H-X30W-01	2700K	3750	>80
SC-PSCAWCE3012-H-X40W-01	5000K	5040	>80
SC-PSCAWNE3012-H-X40W-01	4500K	5080	>80
SC-PSCAWNE3012-H-X40W-01	4000K	5080	>80
SC-PSCAWWE3012-H-X40W-01	3500K	5000	>80
SC-PSCAWWE3012-H-X40W-01	3000K	5000	>80
SC-PSCAWWE3012-H-X40W-01	2700K	5000	>80
SC-PSCAWCE6012-H-X30W-01	5000K	3780	>80
SC-PSCAWNE6012-H-X30W-01	4500K	3810	>80
SC-PSCAWNE6012-H-X30W-01	4000K	3810	>80
SC-PSCAWWE6012-H-X30W-01	3500K	3750	>80
SC-PSCAWWE6012-H-X30W-01	3000K	3750	>80
SC-PSCAWWE6012-H-X30W-01	2700K	3750	>80
SC-PSCAWCE6012-H-X35W-01	5000K	4410	>80
SC-PSCAWNE6012-H-X35W-01	4500K	4445	>80
SC-PSCAWNE6012-H-X35W-01	4000K	4445	>80
SC-PSCAWWE6012-H-X35W-01	3500K	4375	>80
SC-PSCAWWE6012-H-X35W-01	3000K	4375	>80
SC-PSCAWWE6012-H-X35W-01	2700K	4375	>80
SC-PSCAWCE6012-H-X40W-01	5000K	5040	>80
SC-PSCAWNE6012-H-X40W-01	4500K	5080	>80
SC-PSCAWNE6012-H-X40W-01	4000K	5080	>80
SC-PSCAWWE6012-H-X40W-01	3500K	5000	>80
SC-PSCAWWE6012-H-X40W-01	3000K	5000	>80
SC-PSCAWWE6012-H-X40W-01	2700K	5000	>80
SC-PSCAWCE6012-H-X50W-01	5000K	6300	>80
SC-PSCAWNE6012-H-X50W-01	4500K	6350	>80
SC-PSCAWNE6012-H-X50W-01	4000K	6350	>80
SC-PSCAWWE6012-H-X50W-01	3500K	6250	>80
SC-PSCAWWE6012-H-X50W-01	3000K	6250	>80
SC-PSCAWWE6012-H-X50W-01	2700K	6250	>80
SC-PSCAWCE6012-H-X60W-01	5000K	7560	>80
SC-PSCAWNE6012-H-X60W-01	4500K	7620	>80
SC-PSCAWNE6012-H-X60W-01	4000K	7620	>80
SC-PSCAWWE6012-H-X60W-01	3500K	7500	>80
SC-PSCAWWE6012-H-X60W-01	3000K	7500	>80
SC-PSCAWWE6012-H-X60W-01	2700K	7500	>80



**X Series LED Panel Light** 2\*2 feet / 2\*4 feet / 1\*4 feet 100lm/w, 125lm/w 100-347VAC for Canadian market

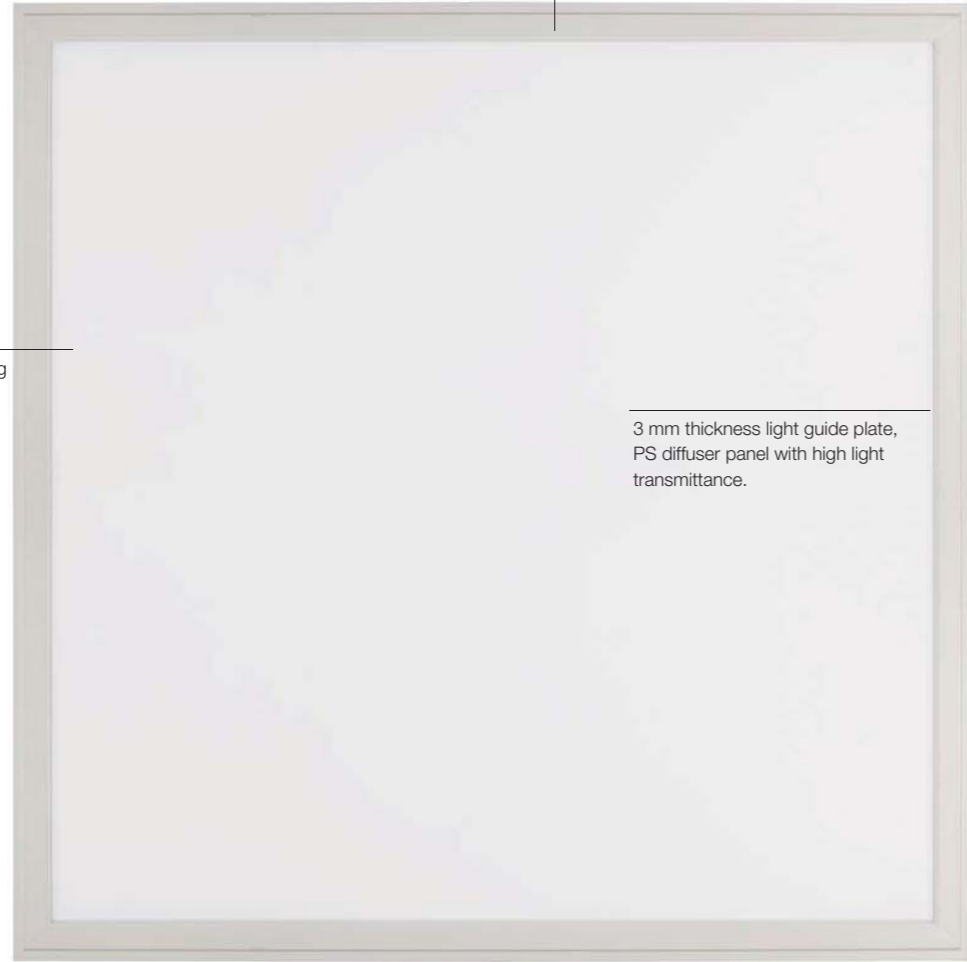

white housing,RAL9003.  
6063 aluminum frame.  
super slim 8.6mm thickness.

Use reflective sheeting  
and aluminum back  
cover to prevent  
light leaking.

3 mm thickness light guide plate,  
PS diffuser panel with high light  
transmittance.



2835 SMD LED chip, high luminous  
efficacy with reliable quality,  
more than 50,000 hours life time.



LED driver: isolated constant  
current design, Low heat, and  
high efficiency up to 85%.PF>0.95.

Size:(in.) 2x2 feet

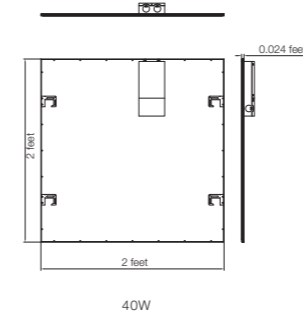

Size:(in.) 1x4 feet

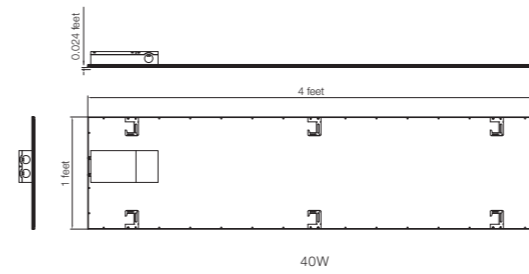

Size:(in.) 2x4 feet

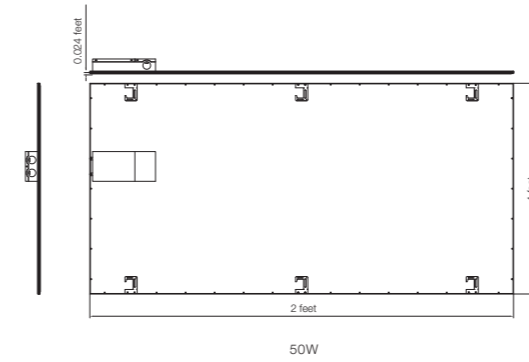

Model number	CCT	Light output (±10%)lm	CRI
SC-PSCBWCE6060-X40W	5000K	4400	>80
SC-PSCBWNE6060-X40W	4000K	4400	>80
SC-PSCBWWE6060-X40W	3000K	4200	>80
SC-PSCBWCE6060-H-X40W	5000K	5120	>80
SC-PSCBWNE6060-H-X40W	4000K	5040	>80
SC-PSCBWWE6060-H-X40W	3000K	4960	>80

Model number	CCT	Light output (±10%)lm	CRI
SC-PSCBWCE3012-X40W	5000K	4400	>80
SC-PSCBWNE3012-X40W	4000K	4400	>80
SC-PSCBWWE3012-X40W	3000K	4200	>80
SC-PSCBWCE3012-H-X40W	5000K	5120	>80
SC-PSCBWNE3012-H-X40W	4000K	5040	>80
SC-PSCBWWE3012-H-X40W	3000K	4960	>80

Model number	CCT	Light output (±10%)lm	CRI
SC-PSCBWCE6012-X50W	5000K	5500	>80
SC-PSCBWNE6012-X50W	4000K	5500	>80
SC-PSCBWWE6012-X50W	3000K	5250	>80
SC-PSCBWCE6012-H-X50W	5000K	6500	>80
SC-PSCBWNE6012-H-X50W	4000K	6400	>80
SC-PSCBWWE6012-H-X50W	3000K	6150	>80



# R Series Square Panel Light 80-90lm/w for European market

295\*295mm / 295\*595mm / 595\*595mm / 295\*1195mm / 595\*1195mm

white housing, RAL9003.  
6063 aluminum frame.  
super slim 8.6mm thickness.

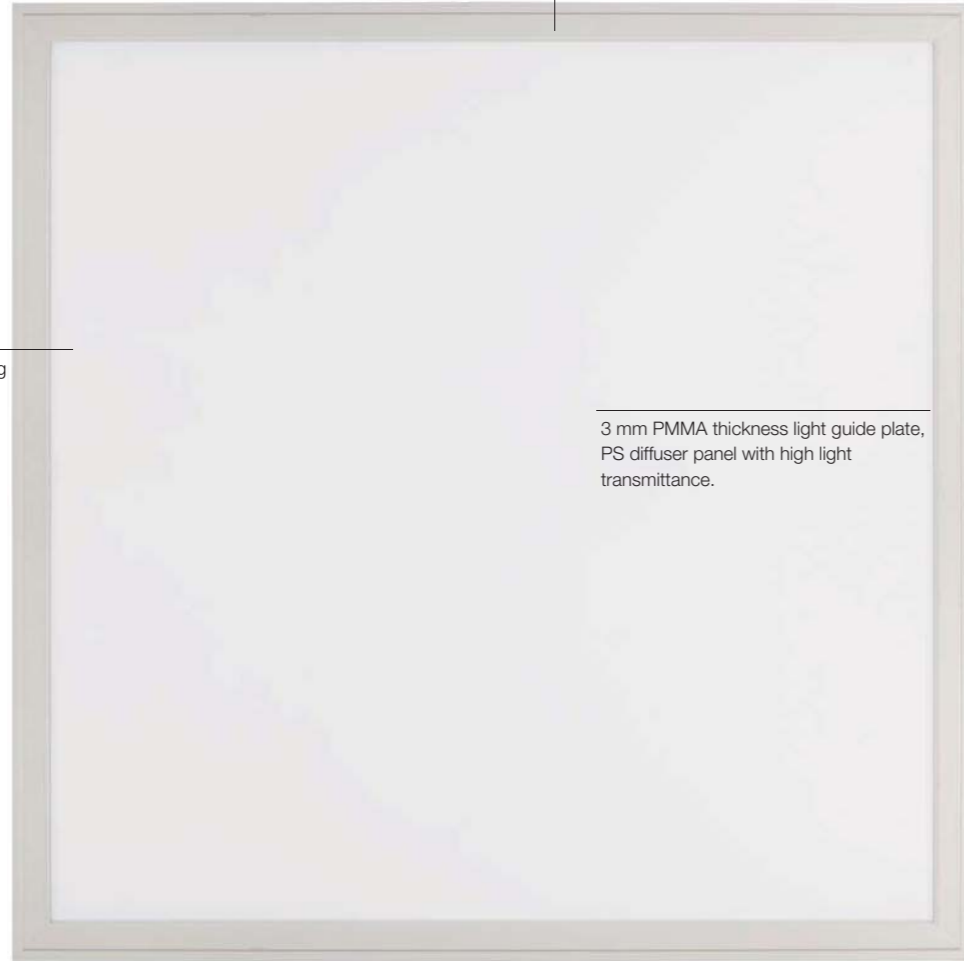

Use reflective sheeting and aluminum back cover to prevent light leaking.

3 mm PMMA thickness light guide plate, PS diffuser panel with high light transmittance.



4014 SMD LED chip, high luminous efficacy with reliable quality, more than 50,000 hours life time.



LED driver: isolated constant current design, Low heat, and high efficiency up to 85%, PF>0.95.

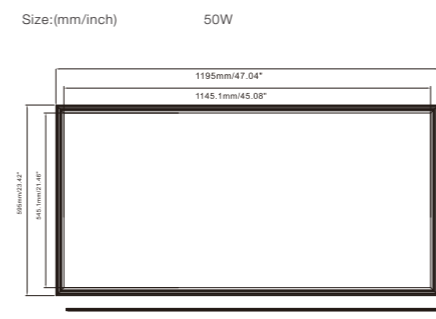
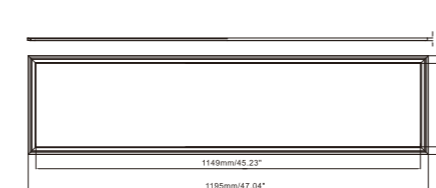
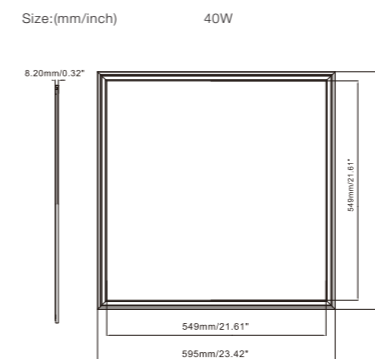
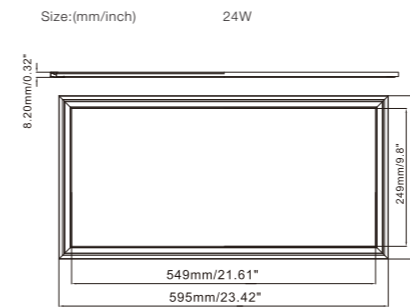
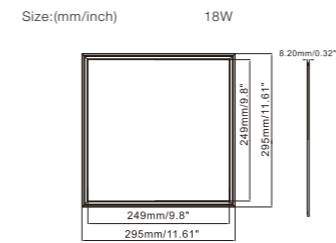

Model number	CCT	Light output (±10%)lm	CRI
SC-PSC24CE3030-R18W	6000-6500K	1620K	>80
SC-PSC24NE3030-R18W	3800-4200K	1620K	>80
SC-PSC24WE3030-R18W	2800-3200K	1584K	>80

Model number	CCT	Light output (±10%)lm	CRI
SC-PSC24CE3060-R24W	6000-6500K	2160K	>80
SC-PSC24NE3060-R24W	3800-4200K	2160K	>80
SC-PSC24WE3060-R24W	2800-3200K	2112K	>80

Model number	CCT	Light output (±10%)lm	CRI
SC-PSC24CE6060-R40W	6000-6500K	3600K	>80
SC-PSC24NE6060-R40W	3800-4200K	3600K	>80
SC-PSC24WE6060-R40W	2800-3200K	3520K	>80

Model number	CCT	Light output (±10%)lm	CRI
SC-PSC24CE3012-R40W	6000-6500K	3600K	>80
SC-PSC24NE3012-R40W	3800-4200K	3600K	>80
SC-PSC24WE3012-R40W	2800-3200K	3520K	>80

Model number	CCT	Light output (±10%)lm	CRI
SC-PSC24CE6012-R50W	6000-6500K	5000K	>80
SC-PSC24NE6012-R50W	3800-4200K	5000K	>80
SC-PSC24WE6012-R50W	2800-3200K	4900K	>80



**R Series Square Panel Light** 100-110lm/w for European market 595\*595mm / 295\*1195mm / 595\*1195mm

white housing, RAL9003.  
6063 aluminum frame.  
super slim 8.6mm thickness.

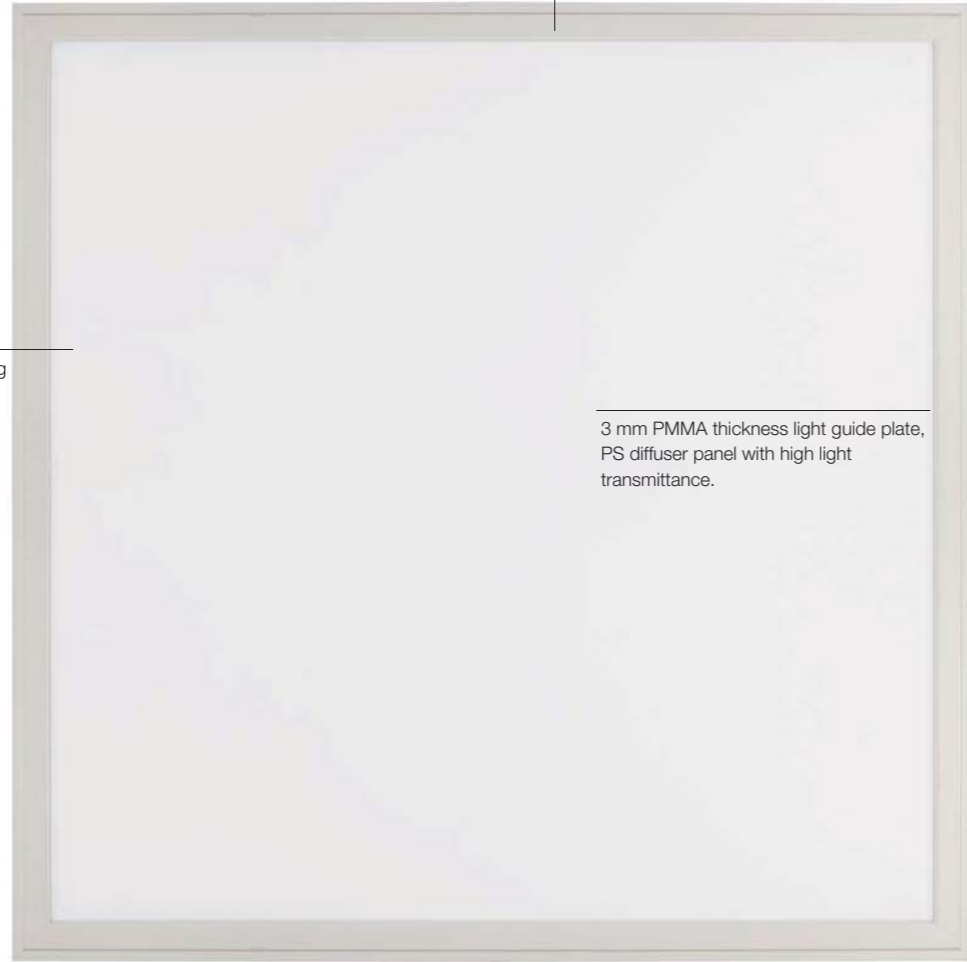

Use reflective sheeting and aluminum back cover to prevent light leaking.

3 mm PMMA thickness light guide plate, PS diffuser panel with high light transmittance.



4014 SMD LED chip, high luminous efficacy with reliable quality, more than 50,000 hours life time.



LED driver: isolated constant current design, Low heat, and high efficiency up to 85%, PF>0.95.

Size:(mm/inch) 40W

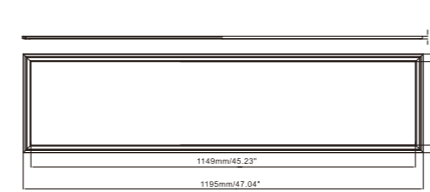
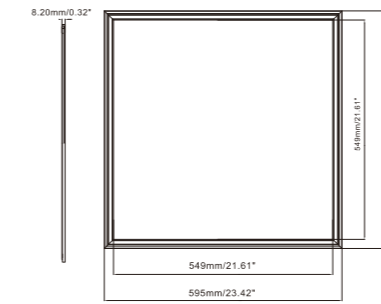

Size:(mm/inch) 50W

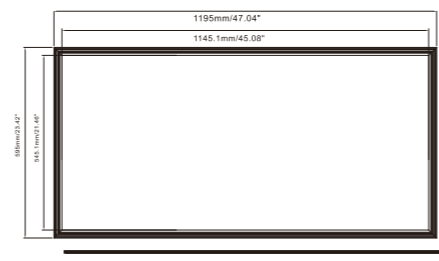

Model number	CCT	Light output (±10%)lm	CRI
SC-PSC24CE6060-R40W-P	6000-6500K	4000	>80
SC-PSC24NE6060-R40W-P	3800-4200K	4000	>80
SC-PSC24WE6060-R40W-P	2800-3200K	3920	>80

Model number	CCT	Light output (±10%)lm	CRI
SC-PSC24CE3012-R40W-P	6000-6500K	4000	>80
SC-PSC24NE3012-R40W-P	3800-4200K	4000	>80
SC-PSC24WE3012-R40W-P	2800-3200K	3920	>80

Model number	CCT	Light output (±10%)lm	CRI
SC-PSC24CE6012-R50W-P	6000-6500K	5000	>80
SC-PSC24NE6012-R50W-P	3800-4200K	5000	>80
SC-PSC24WE6012-R50W-P	2800-3200K	4900	>80





# R Series Square Panel Light 120lm/w for European market 595\*595mm / 295\*1195mm / 595\*1195mm

white housing, RAL9003.  
6063 aluminum frame.  
super slim 8.6mm thickness.

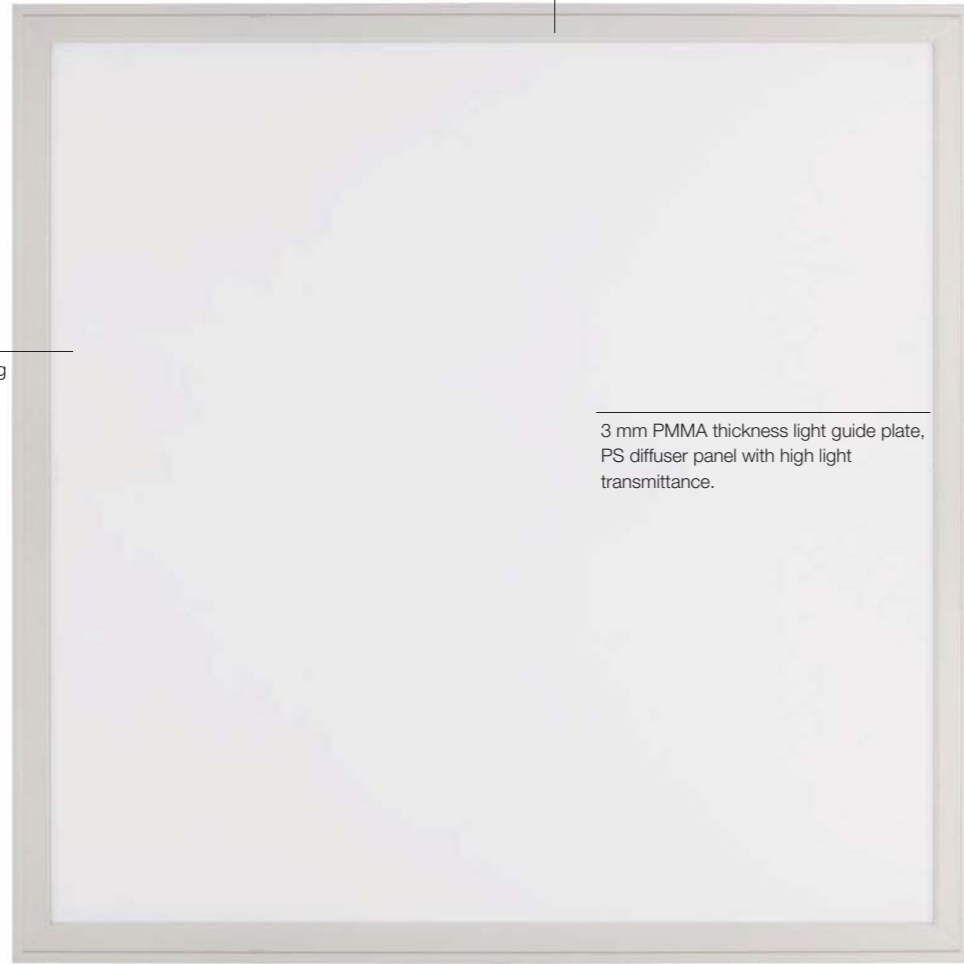

Use reflective sheeting and aluminum back cover to prevent light leaking.

3 mm PMMA thickness light guide plate, PS diffuser panel with high light transmittance.



4014 SMD LED chip, high luminous efficacy with reliable quality, more than 50,000 hours life time.



LED driver: isolated constant current design, Low heat, and high efficiency up to 85%, PF>0.95.

Size:(mm/inch) 40W

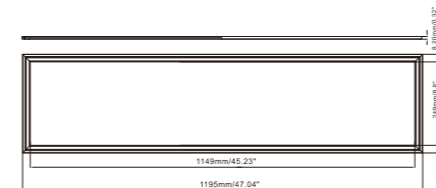
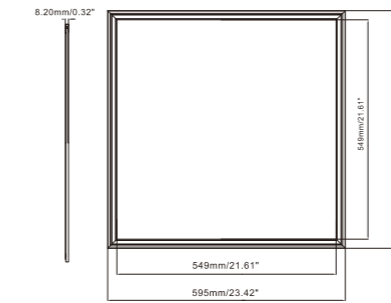

Size:(mm/inch) 50W

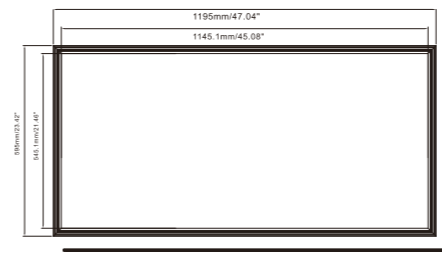

Model number	CCT	Light output (±10%)lm	CRI
SC-PSC24CE6060-R40W-H	6000-6500K	4800	>80
SC-PSC24NE6060-R40W-H	3800-4200K	4800	>80
SC-PSC24WE6060-R40W-H	2800-3200K	4720	>80

Model number	CCT	Light output (±10%)lm	CRI
SC-PSC24CE3012-R40W-H	6000-6500K	4800	>80
SC-PSC24NE3012-R40W-H	3800-4200K	4800	>80
SC-PSC24WE3012-R40W-H	2800-3200K	4720	>80

Model number	CCT	Light output (±10%)lm	CRI
SC-PSC24CE6012-R50W-H	6000-6500K	6000	>80
SC-PSC24NE6012-R50W-H	3800-4200K	6000	>80
SC-PSC24WE6012-R50W-H	2800-3200K	5900	>80



# K Series

Color tunable and dimmable LED panel light with bluetooth control system.

white housing, RAL9003.  
6063 aluminum frame.  
super slim 9.5mm thickness.



Use reflective sheeting and aluminum back cover to prevent light leaking.

3 mm thickness light guide plate, brand: Mitsubishi from Japan.  
PS diffuser panel with high light transmittance.



APP



Remote controller



Remote panel



Size:(mm) 45W

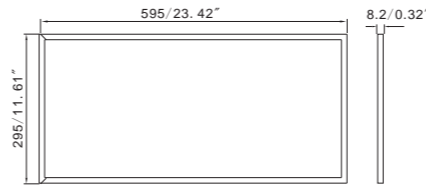
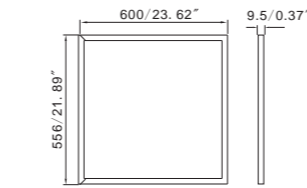

Size:(mm) 50W

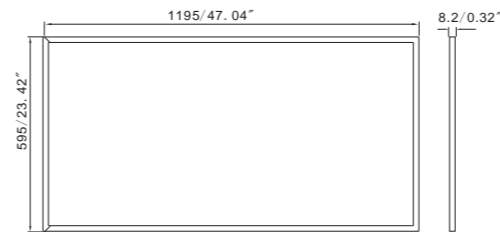

Model number	CCT	Light output (±10%)lm	CRI
SC-PSD24DE6060-K45W	5500-6500K	3547	>80
	4000-4500K	3409	>80
	2700-3200K	3174	>80

Model number	CCT	Light output (±10%)lm	CRI
SC-PSD24DE3012-K45W	5500-6500K	3547	>80
	4000-4500K	3409	>80
	2700-3200K	3174	>80

Model number	CCT	Light output (±10%)lm	CRI
SC-PSD24DE6012-K50W	5500-6500K	5000	>80
	4000-4500K	5000	>80
	2700-3200K	4500	>80



# Narrow Frame Panel Light Series

600\*600mm

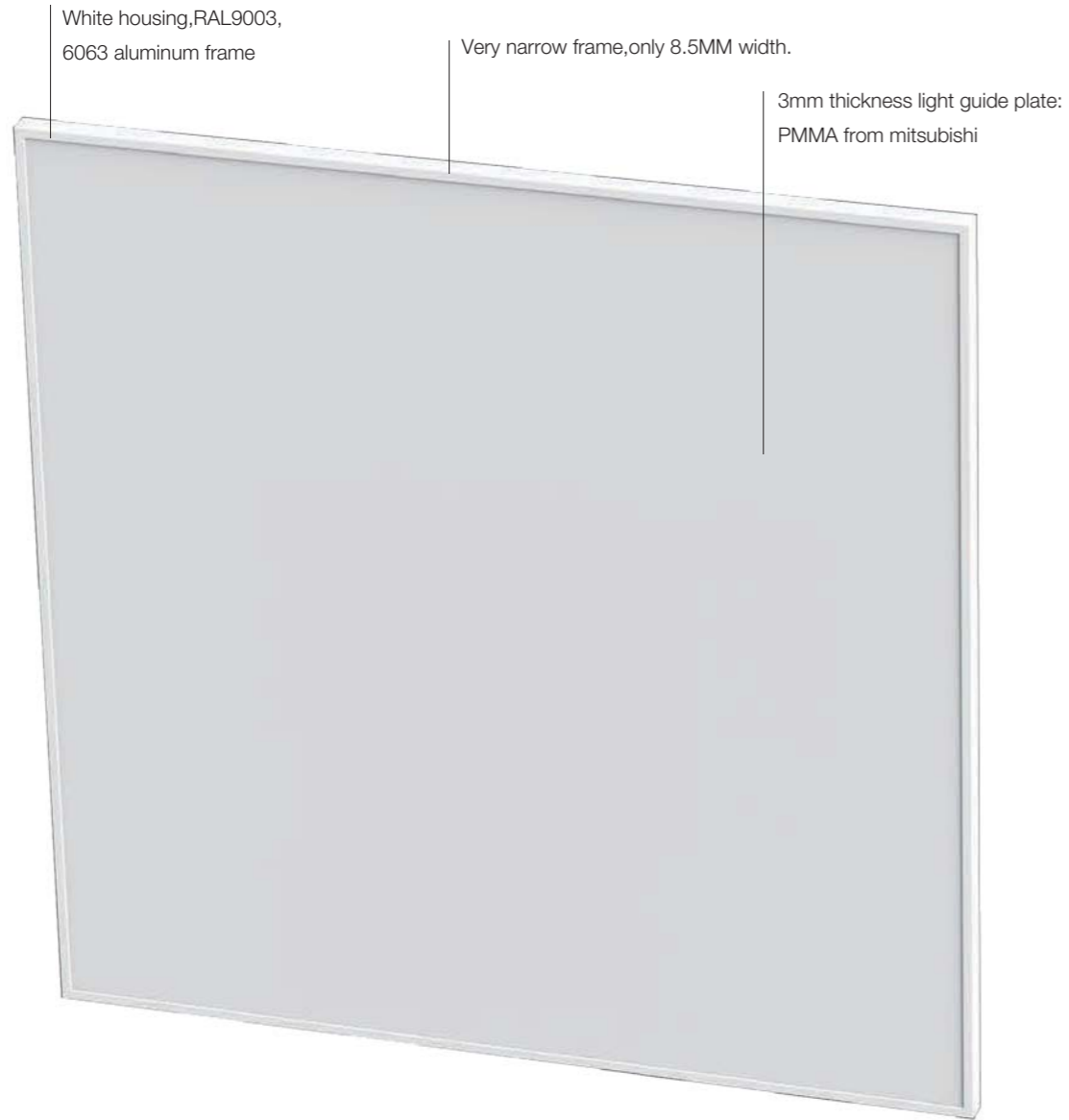

Size:(mm) 40W

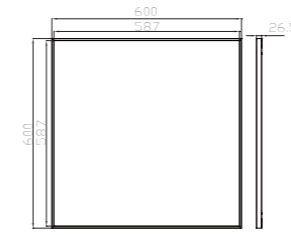

Model number	CCT	Light output (±10%)lm	CRI
SC-PSC24CE6060-Z40W	5500-6500K	4000	>80
SC-PSC24NE6060-Z40W	4000-4500K	4000	>80
SC-PSC24WE6060-Z40W	2700-3200K	3400	>80

Suspendent installation

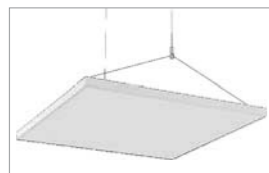

Ceiling installation

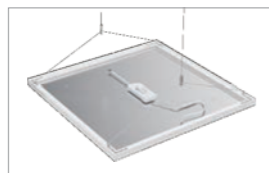

4014 SMD LED chip, high luminous efficacy with reliable quality,  
more than 50,000 hours life time.

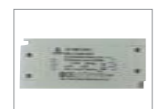

LED driver: isolated constant current design,  
low heat, and high efficiency up to 85%, PF>0.95.



# Suspended installation



Position of surface in room  
Marked point:  
(0.000 m, 5.880 m, 0.000 m)

Values in Lux, Scale 1 : 100

Grid: 128 x 128 Points

$E_{av}$ [lx]	$E_{min}$ [lx]	$E_{max}$ [lx]	u0	$E_{min}/E_{max}$
55	6.00	107	0.110	0.056

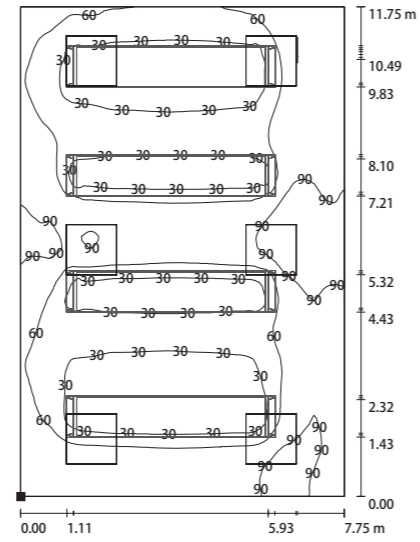

Position of surface in room  
Marked point:  
(0.000 m, 5.880 m, 1.500 m)

Values in Lux, Scale 1 : 100

Grid: 128 x 128 Points

$E_{av}$ [lx]	$E_{min}$ [lx]	$E_{max}$ [lx]	u0	$E_{min}/E_{max}$
94	8.71	216	0.093	0.040

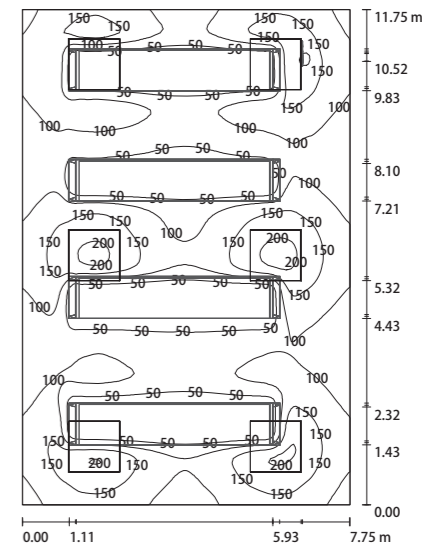

Position of surface in room  
Marked point:  
(0.000 m, 5.880 m, 0.750 m)

Values in Lux, Scale 1 : 100

Grid: 128 x 128 Points

$E_{av}$ [lx]	$E_{min}$ [lx]	$E_{max}$ [lx]	u0	$E_{min}/E_{max}$
70	6.44	139	0.092	0.046

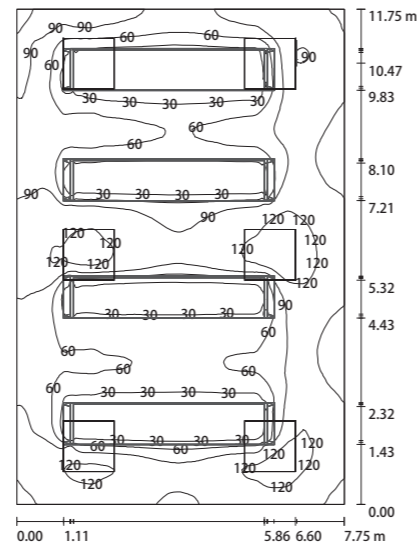

# Embedded Installation

Indoor Space / Calculation Surface 1 / Isolines (E, Perpendicular)



Values in Lux, Scale 1 : 26

Position of surface in room  
 Marked point:  
 (2.406 m, 11.446 m, 0.850 m)

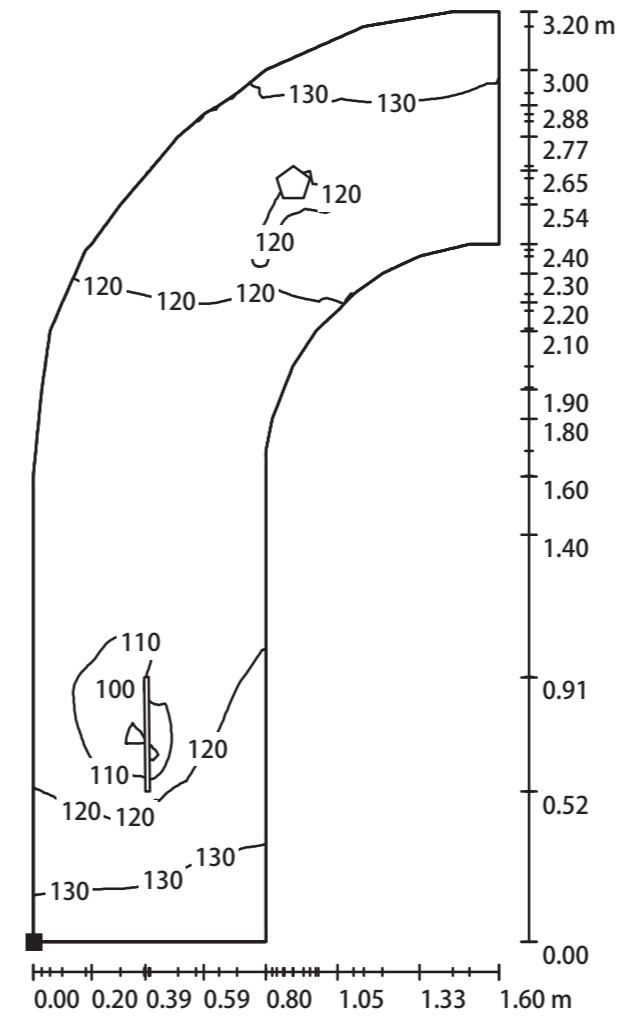
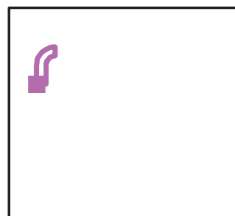

Grid: 128 x 128 Points

$E_{av}$ [lx]	$E_{min}$ [lx]	$E_{max}$ [lx]	u0	$E_{min}/E_{max}$
121	96	136	0.791	0.704



### LED Slim Panel Light Round Series 2835 SMD LED

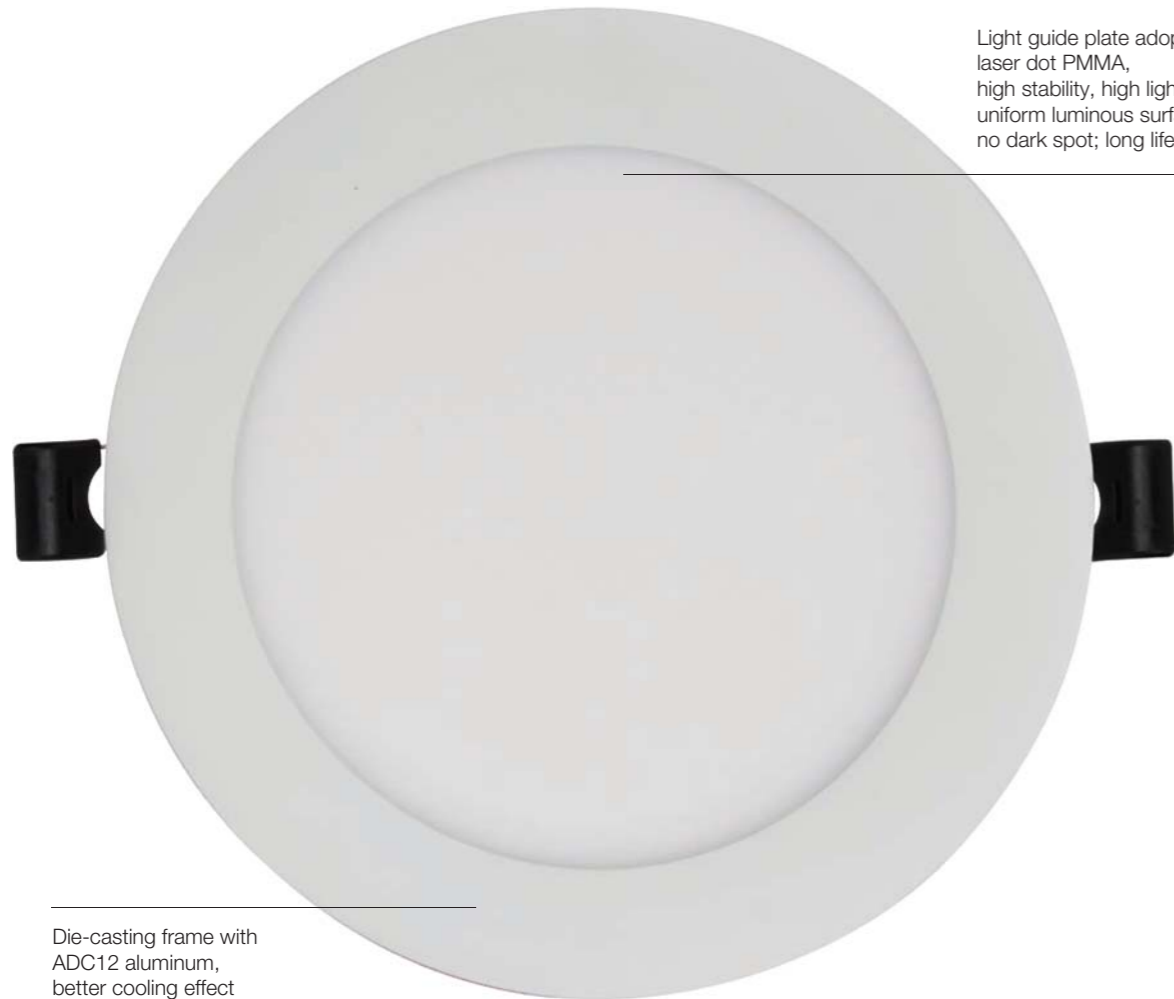

Light guide plate adopt imported laser dot PMMA, high stability, high lighting effect, uniform luminous surface, no dark spot; long lifetime;

Die-casting frame with ADC12 aluminum, better cooling effect

Size:(mm)

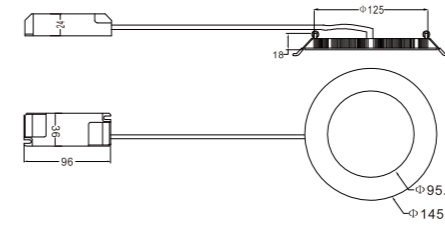

Size:(mm)

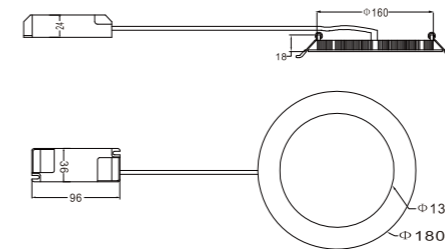

Size:(mm)

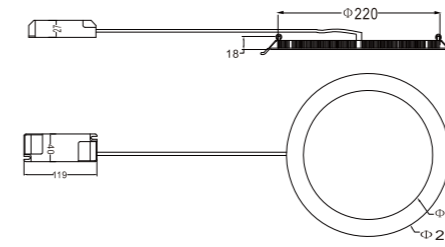

Model number	CCT	Light output (±10%)lm	CRI
DL-010-AW-01CW-R	5700-6500K	722	>80
DL-010-AW-01NW-R	3700-4500K	730	>80
DL-010-AW-01WW-R	2700-3200K	710	>80

Model number	CCT	Light output (±10%)lm	CRI
DL-015-AW-01CW-R	5700-6500K	1245	>80
DL-015-AW-01NW-R	3700-4500K	1252	>80
DL-015-AW-01WW-R	2700-3200K	1222	>80

Model number	CCT	Light output (±10%)lm	CRI
DL-020-AW-01CW-R	5700-6500K	1660	>80
DL-020-AW-01NW-R	3700-4500K	1650	>80
DL-020-AW-01WW-R	2700-3200K	1580	>80



LED: 2835 SMD LED chip, high luminous efficacy with reliable quality, more than 50,000 hours life time.



LED driver: isolated constant current design, low heat, and high efficiency up to 85%,PF>0.95



### LED Slim Panel Light Square Series 2835 SMD LED

Light guide plate adopt imported laser dot PMMA, high stability, high lighting effect, uniform luminous surface, no dark spot; long lifetime;

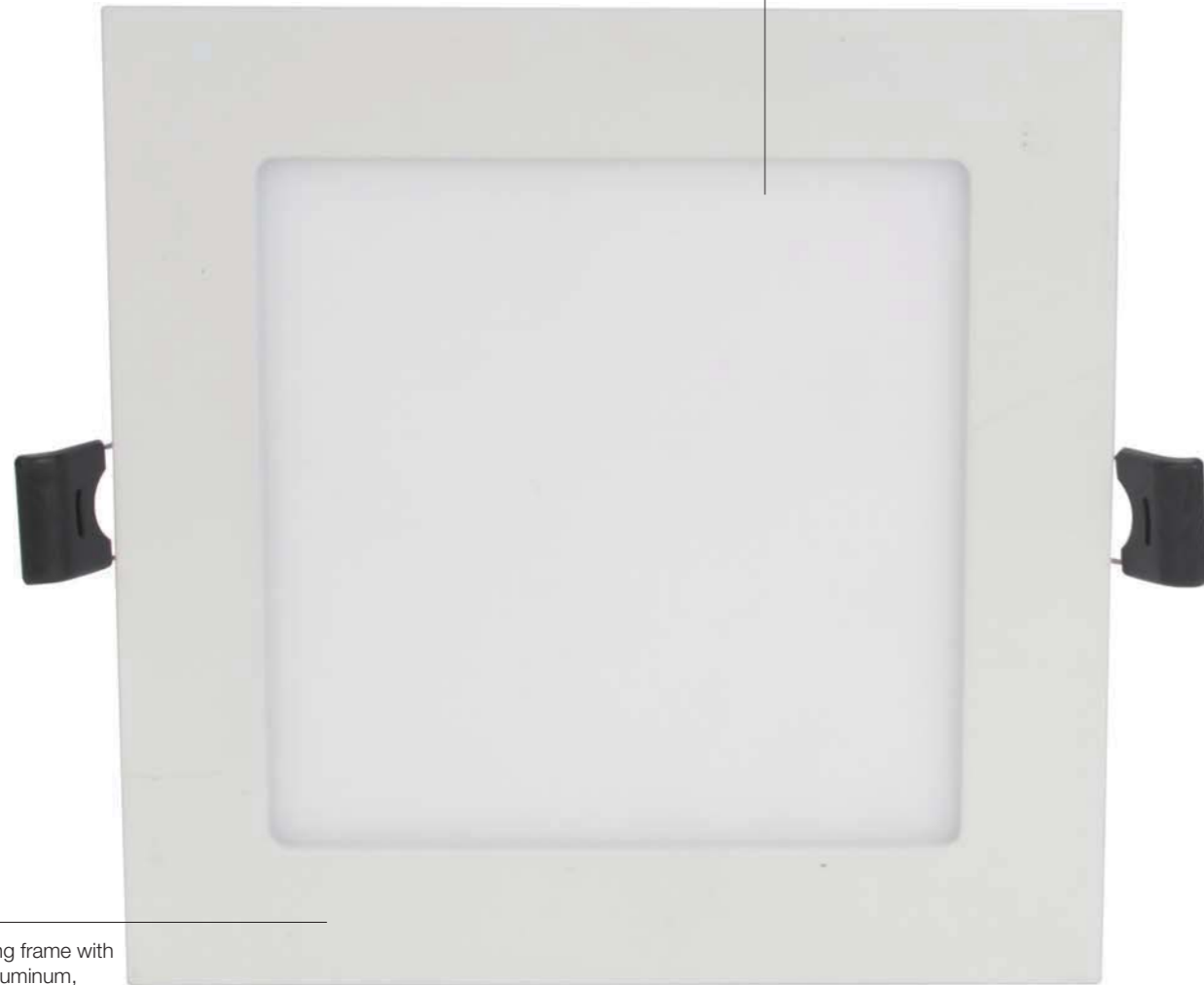

Die-casting frame with ADC12 aluminum, better cooling effect



LED: 2835 SMD LED chip, high luminous efficacy with reliable quality, more than 50,000 hours life time.



LED driver: isolated constant current design, low heat, and high efficiency up to 85%, PF>0.95



Size:(mm)



Size:(mm)

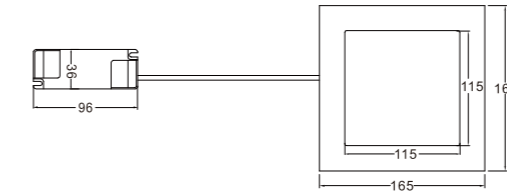
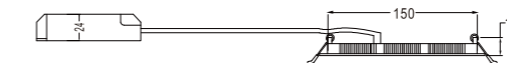

Model number	CCT	Light output (±10%)lm	CRI
SC-PSC24CE115115-R10W	5700-6500K	620	>80
SC-PSC24NE115115-R10W	3700-4500K	630	>80
SC-PSC24WE115115-R10W	2700-3200K	600	>80

Model number	CCT	Light output (±10%)lm	CRI
SC-PSC24CE165165-R15W	5700-6500K	1290	>80
SC-PSC24NE165165-R15W	3700-4500K	1290	>80
SC-PSC24WE165165-R15W	2700-3200K	1260	>80



# LED Slim Panel Light ETL Approved Version

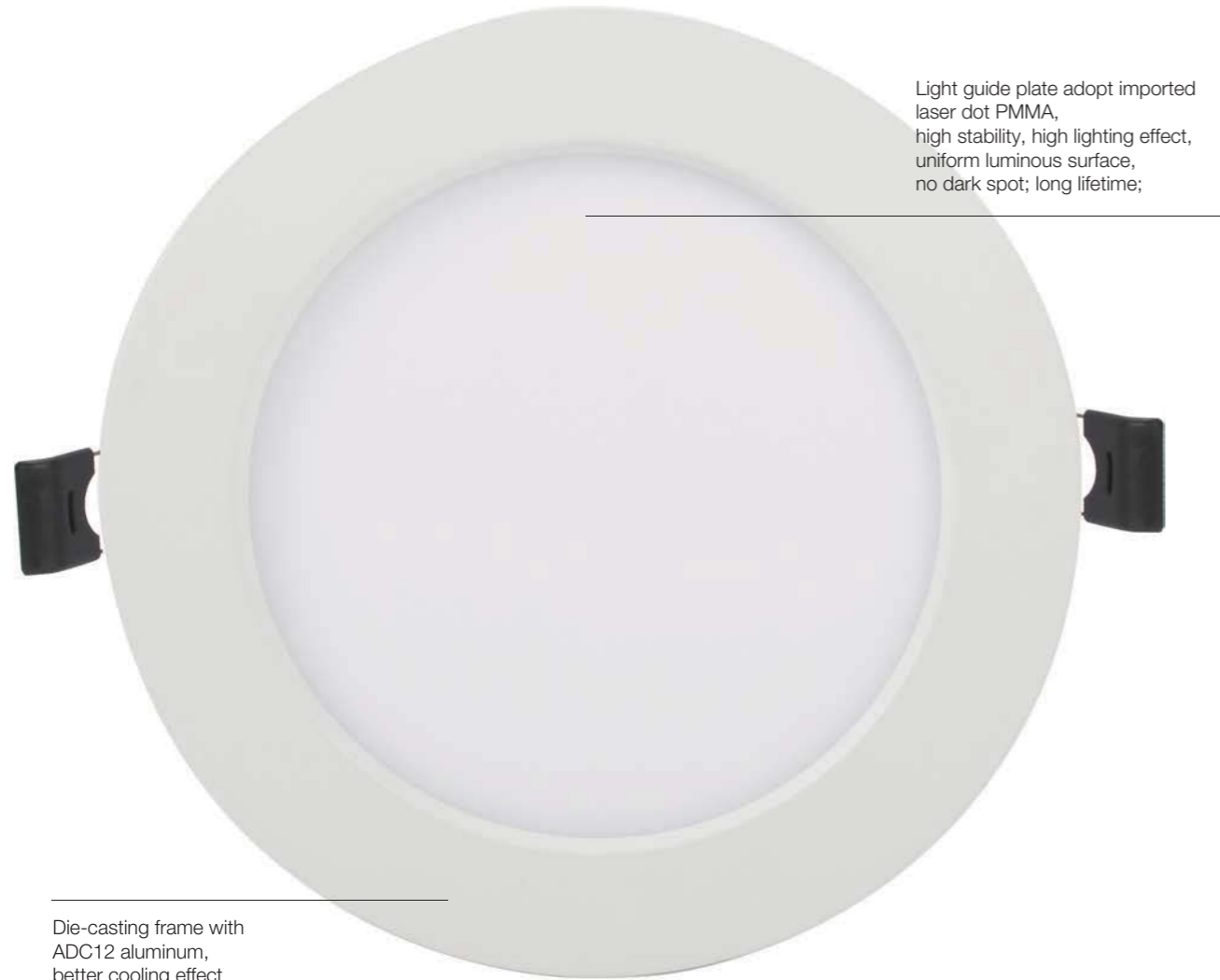

Light guide plate adopt imported laser dot PMMA, high stability, high lighting effect, uniform luminous surface, no dark spot; long lifetime;

Die-casting frame with ADC12 aluminum, better cooling effect



LED: 2835 SMD LED chip, high luminous efficacy with reliable quality, more than 50,000 hours life time.



LED driver: isolated constant current design, low heat, and high efficiency up to 85%,PF>0.95



Size:(mm) 6W

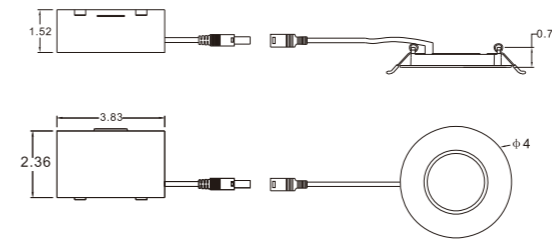

Size:(mm) 9W

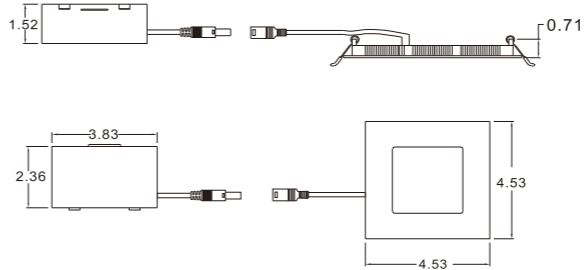
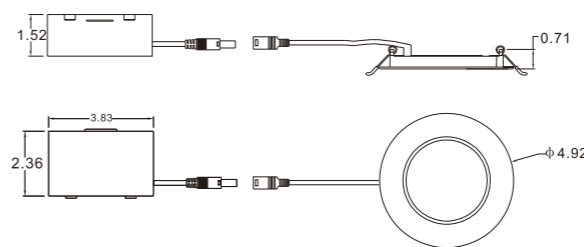

Size:(mm) 12W

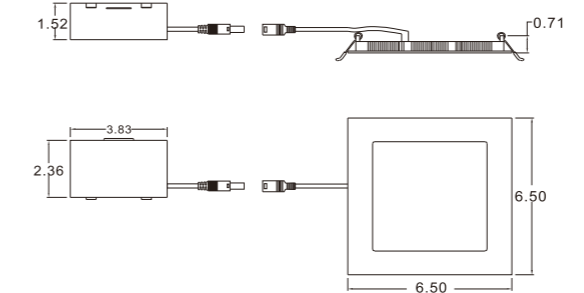
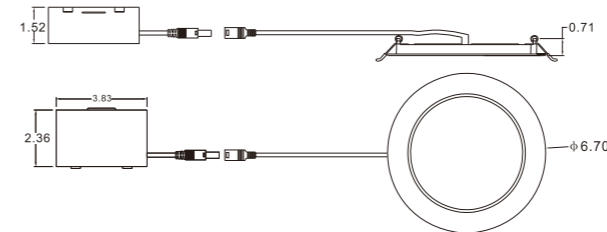

Model number	CCT	Light output (±10%)lm	CRI
SC-DL06-R03-A1-01CE	5000K	360	>80
SC-DL06-R03-A1-01DE	4500K	360	>80
SC-DL06-R03-A1-01NE	4000K	360	>80
SC-DL06-R03-A1-01BE	3500K	336	>80
SC-DL06-R03-A1-01WE	3000K	336	>80

Model number	CCT	Light output (±10%)lm	CRI
SC-DL09-R04-A1-01CE	5000K	580	>80
SC-DL09-R04-A1-01DE	4500K	580	>80
SC-DL09-R04-A1-01NE	4000K	580	>80
SC-DL09-R04-A1-01BE	3500K	540	>80
SC-DL09-R04-A1-01WE	3000K	540	>80

SC-FL09-R04-A1-01CE	5000K	580	>80
SC-FL09-R04-A1-01DE	4500K	580	>80
SC-FL09-R04-A1-01NE	4000K	580	>80
SC-FL09-R04-A1-01BE	3500K	540	>80
SC-FL09-R04-A1-01WE	3000K	540	>80

Model number	CCT	Light output (±10%)lm	CRI
SC-DL12-R06-A1-01CE	5000K	900	>80
SC-DL12-R06-A1-01DE	4500K	900	>80
SC-DL12-R06-A1-01NE	4000K	900	>80
SC-DL12-R06-A1-01BE	3500K	820	>80
SC-DL12-R06-A1-01WE	3000K	820	>80

SC-FL12-R06-A1-01CE	5000K	900	>80
SC-FL12-R06-A1-01DE	4500K	900	>80
SC-FL12-R06-A1-01NE	4000K	900	>80
SC-FL12-R06-A1-01BE	3500K	820	>80
SC-FL12-R06-A1-01WE	3000K	820	>80

**Color tunable LED Slim Panel Light ETL Approved Version**

Light guide plate adopt imported laser dot PMMA, high stability, high lighting effect, uniform luminous surface, no dark spot; long lifetime;



Die-casting frame with ADC12 aluminum, better cooling effect



Color tunable by dip switch



LED: 2835 SMD LED chip, high luminous efficacy with reliable quality, more than 50,000 hours life time.



LED driver: isolated constant current design, low heat, and high efficiency up to 85%,PF>0.95

Size:(mm) 9W

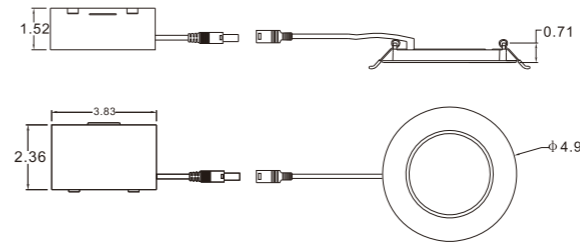

Size:(mm) 12W

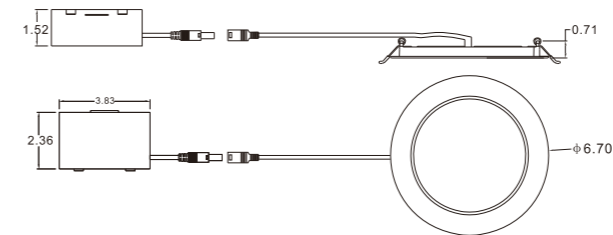

Model number	CCT	Light output (±10%)lm	CRI
SC-DL09-Y04-A1-01RE	2700K-3000K-4000K	600	>90
SC-DL09-Y04-A1-02RE	2700K-3000K-4000K	600	>90

Model number	CCT	Light output (±10%)lm	CRI
SC-DL12-Y06-A1-01RE	2700K-3000K-4000K	900	>90
SC-DL12-Y06-A1-02RE	2700K-3000K-4000K	900	>90
SC-DL12-Y06H-A1-01RE	2700K-3000K-4000K	1100	>90
SC-DL12-Y06H-A1-02RE	2700K-3000K-4000K	1100	>90



# Waterproof round Panel Light IP64

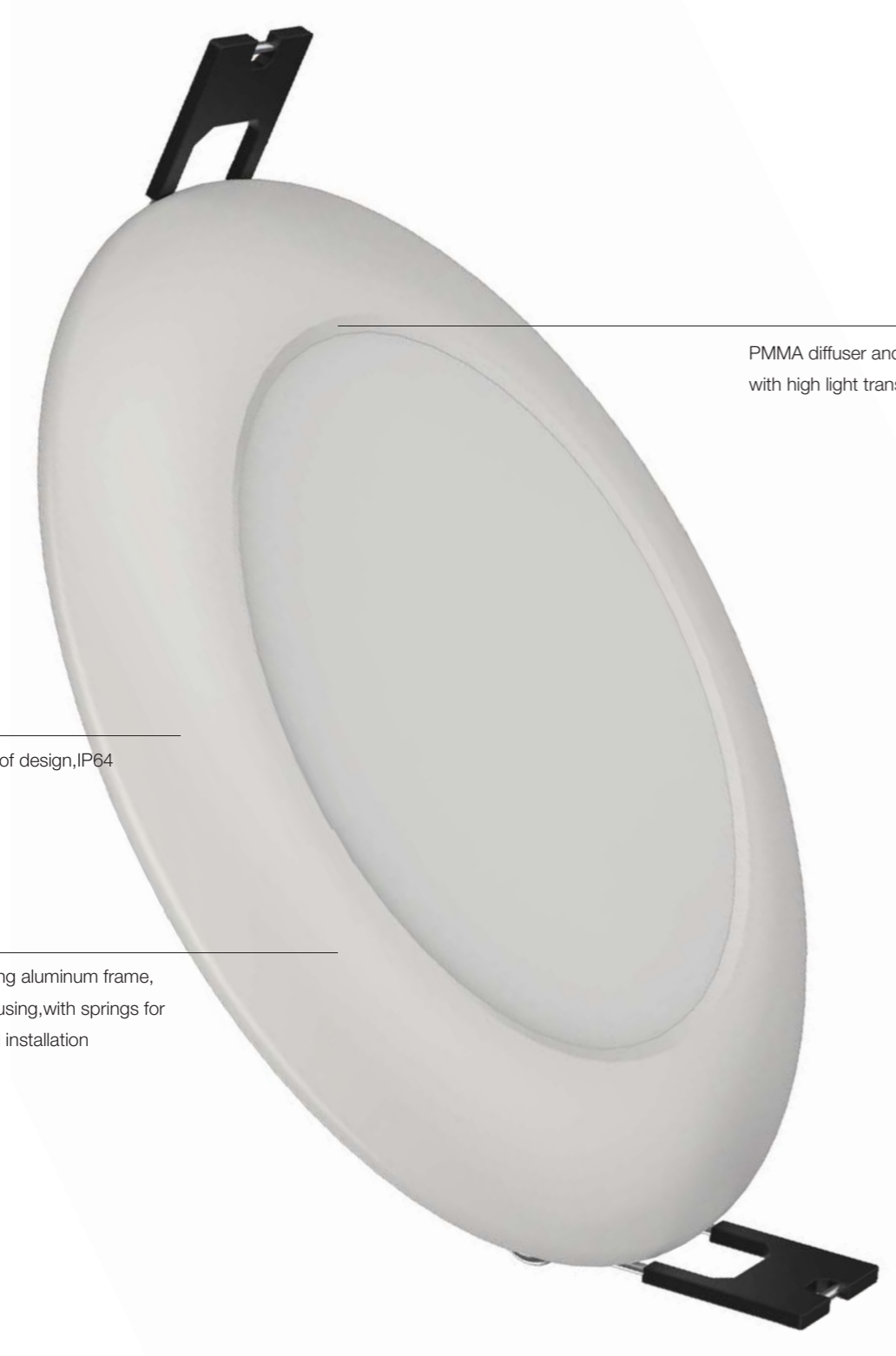

PMMA diffuser and LGP with high light transmittance

waterproof design,IP64

Die casting aluminum frame, white housing,with springs for recessed installation

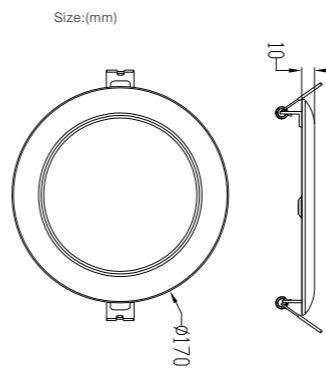
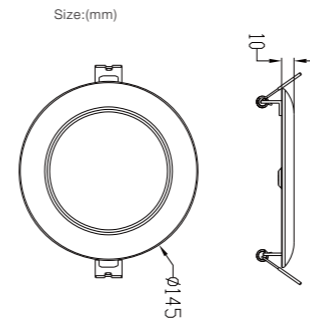

Model number	CCT	Light output (±10%)lm	CRI
DL-008-AW-W-W	5000-6500K	567	>80
DL-008-AW-NW-W	3700-4500K	564	>80
DL-008-AW-WW-W	2700-3200K	523	>80

Model number	CCT	Light output (±10%)lm	CRI
DL-011-AW-W-W	5000-6500K	808	>80
DL-011-AW-NW-W	3700-4500K	820	>80
DL-011-AW-WW-W	2700-3200K	735	>80



# FLOAT Round Suspending Panel Light



Round frame adopt extrusion aluminum, better for heat dissipation, higher hardness, strong structure, have big advantage in large dimension lamp

High lighting effect, uniform light-emitting surface, no ripple

Energy-saving,eco-friendly, no UV,no IR or mercury free, RoHS compliant

Size:(mm)

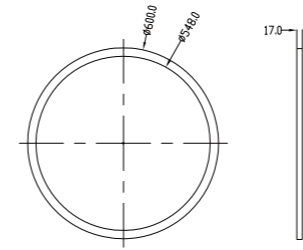

Model number	CCT	Light output (±10%)lm	CRI
DL-055-AW-01CW	6000-6500K	4750	>80
DL-055-AW-01NW	3800-4200K	5000	>80
DL-055-AW-01WW	2800-3200K	4550	>80



# FLOAT Square Suspending Panel Light

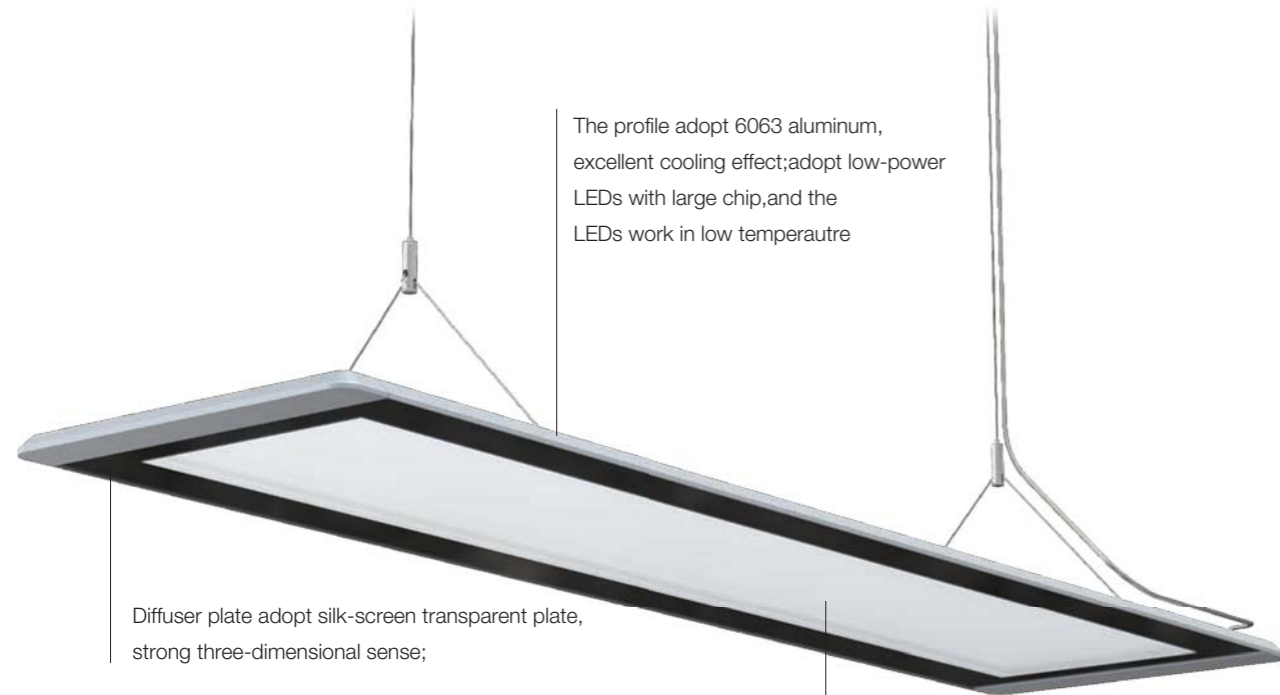

The profile adopt 6063 aluminum, excellent cooling effect; adopt low-power LEDs with large chip, and the LEDs work in low temperature

Diffuser plate adopt silk-screen transparent plate, strong three-dimensional sense;

Side cover of power supply pack adopt magnet technology, no screw, convenient to assemble and disassemble, bottom cover and fixing plate of power supply adopt aluminum profile design, good cooling effect and adopt power supply without flicker

The reflective sheeting adopt imported PMMA with laser dot, high stability, high lighting effect, uniform light-emitting surface, no dark spot;



Size:(mm)

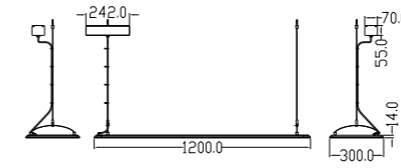

Model number	CCT	Light output (±10%/lm)	CRI
SC-PSC224CV3012-T40W	6000-6500K	3840	>80
SC-PSC224NV3012-T40W	3800-4200K	3840	>80
SC-PSC224WV3012-T40W	2800-3200K	3600	>80

White coating:



# RGB Series Square Panel Light

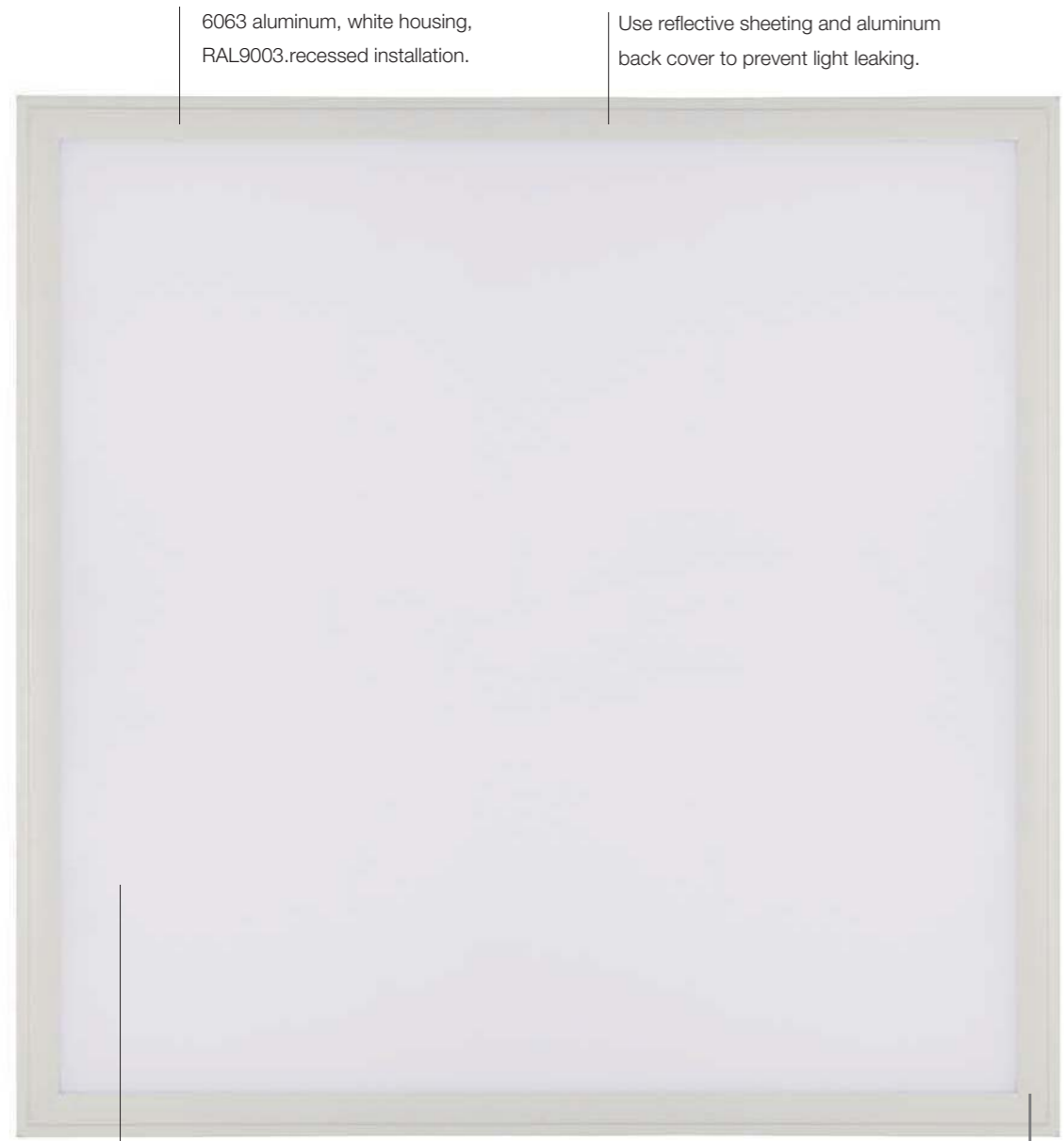

6063 aluminum, white housing, RAL9003.recessed installation.

Use reflective sheeting and aluminum back cover to prevent light leaking.

PMMA diffuser panel with high light transmittance  
6mm thickness light guide plate, brand: Mitsubishi from Japan.



LED: **5050 SMD** LED chip, high luminous efficacy with reliable quality, more than **50,000 hours** life time.



RGB controller included for color changing

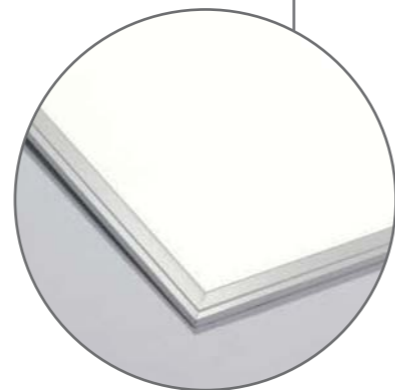

Size:(mm)

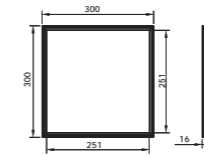

SC-PSF24FE3030

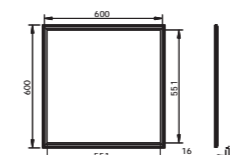

SC-PSF24FE6060

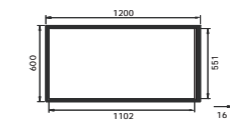

SC-PSF24FE6012

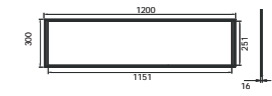

SC-PSF24FE3012



# IP65 Waterproof Panel Light

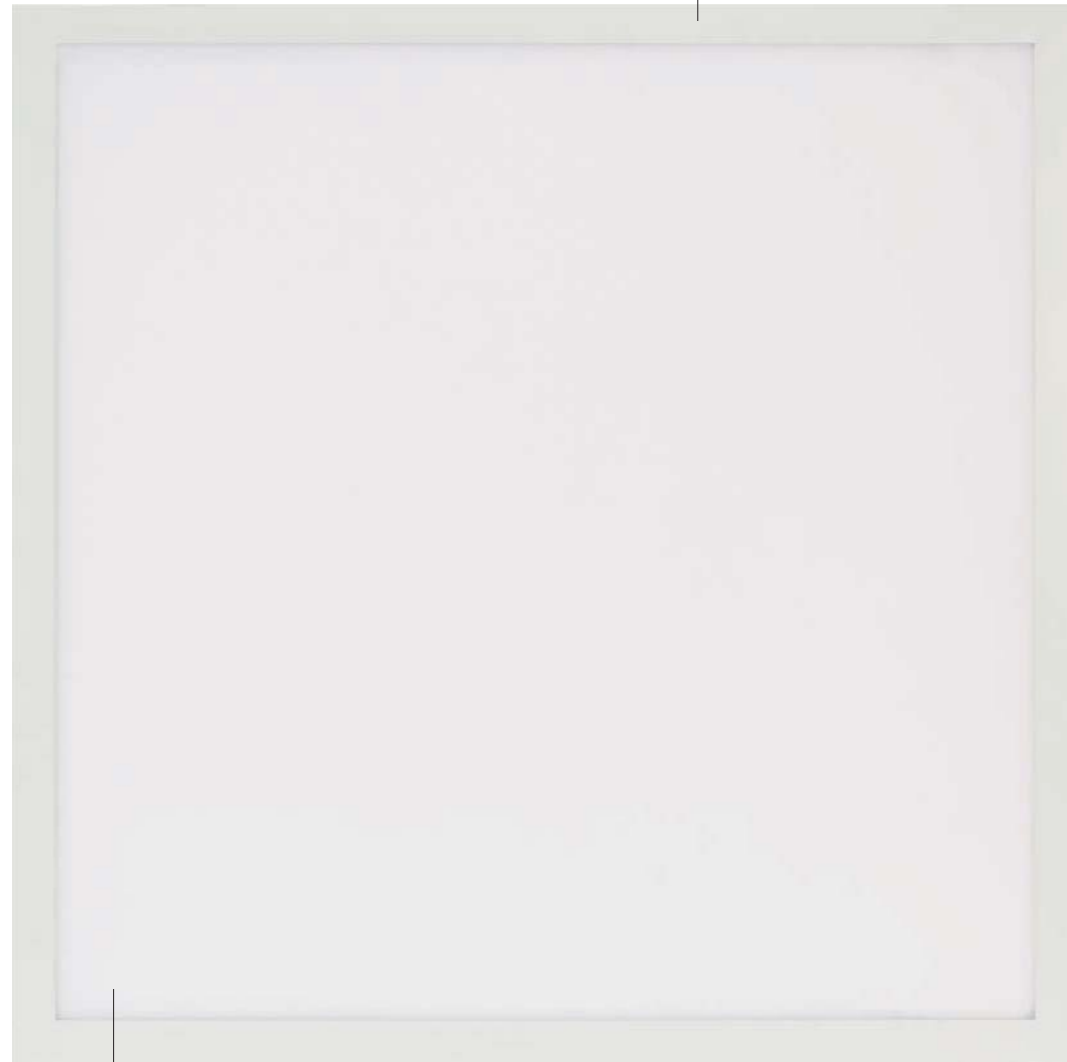

AL6063 aluminum housing,  
13mm thickness,very stronge sturcture

Using PMMA light guide plate,  
up to 90% light transmittance



Special waterproof foem installed at the  
front side between aluminum housing  
and diffuserto achieve the waterproof effect.



LED: **4014 SMD** LED chip, high luminous  
efficacy with reliable quality,  
more than **50,000 hours** life time.



LED driver: isolated constant current design,  
low heat, and high efficiency up to 85%



Size:(mm) 18W

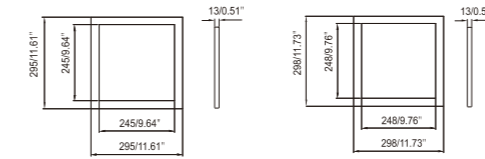

Size:(mm) 24W

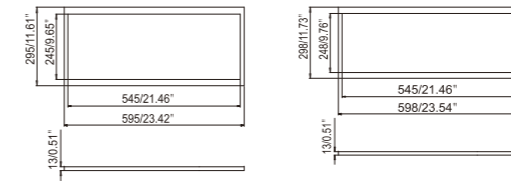

Size:(mm) 40W

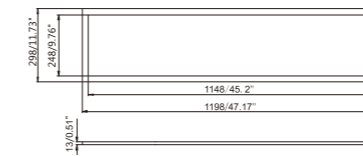
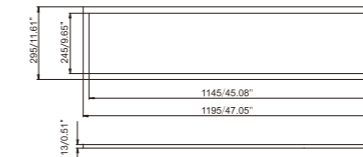
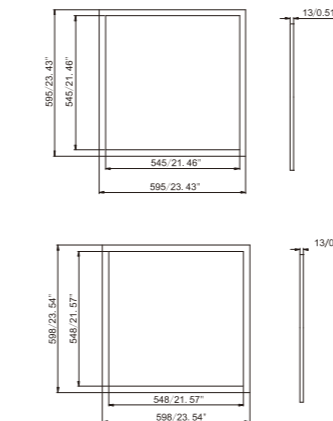

Model number	CCT	Light output (±10%)lm	CRI
SC-PSC24CE3030-W18W	6000-6500K	1656	>80
SC-PSC24NE3030-W18W	3800-4200K	1656	>80
SC-PSC24WE3030-W18W	2800-3200K	1476	>80

Model number	CCT	Light output (±10%)lm	CRI
SC-PSC24CE3060-W24W	6000-6500K	2184	>80
SC-PSC24NE3060-W24W	3800-4200K	2184	>80
SC-PSC24WE3060-W24W	2800-3200K	1968	>80

Model number	CCT	Light output (±10%)lm	CRI
SC-PSC24CE6060-W40W	6000-6500K	4000	>80
SC-PSC24NE6060-W40W	3800-4200K	4000	>80
SC-PSC24WE6060-W40W	2800-3200K	3600	>80
SC-PSC24CE3012-W40W	6000-6500K	4000	>80
SC-PSC24NE3012-W40W	3800-4200K	4000	>80
SC-PSC24WE3012-W40W	2800-3200K	3600	>80

# LED Light Box



The frame can be easily opened by hand for picture changing.



super slim:19.5mm

Size:(mm)

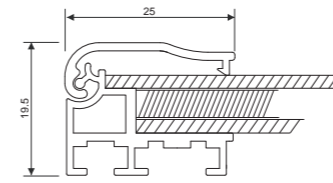

Dimension	Working Voltage	Power
A1 607X853mm	24V DC	28W
A2 433X607mm	24V DC	20W
A3 310X433mm	24V DC	15W
A4 223X310mm	24V DC	8W

\*According to custom size but  
Maximum size: 1500X800mm





## Dimmable panel light

Signcomplex has three dimmable versions of LED panel light: 0-10V, Dali and Triac, just simply replace the regular driver with dimmable driver.

### 0-10V Driver Electrical Connection

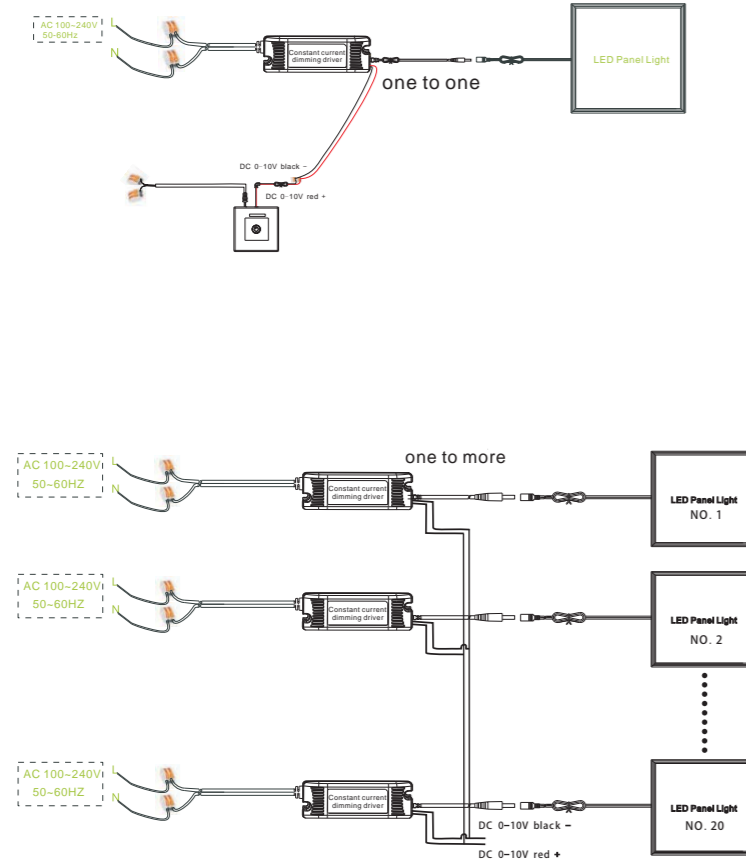

## Dimmable panel light

Signcomplex has three dimmable versions of LED panel light: 0-10V, Dali and Triac, just simply replace the regular driver with dimmable driver.

### Dali Driver Electrical Connection

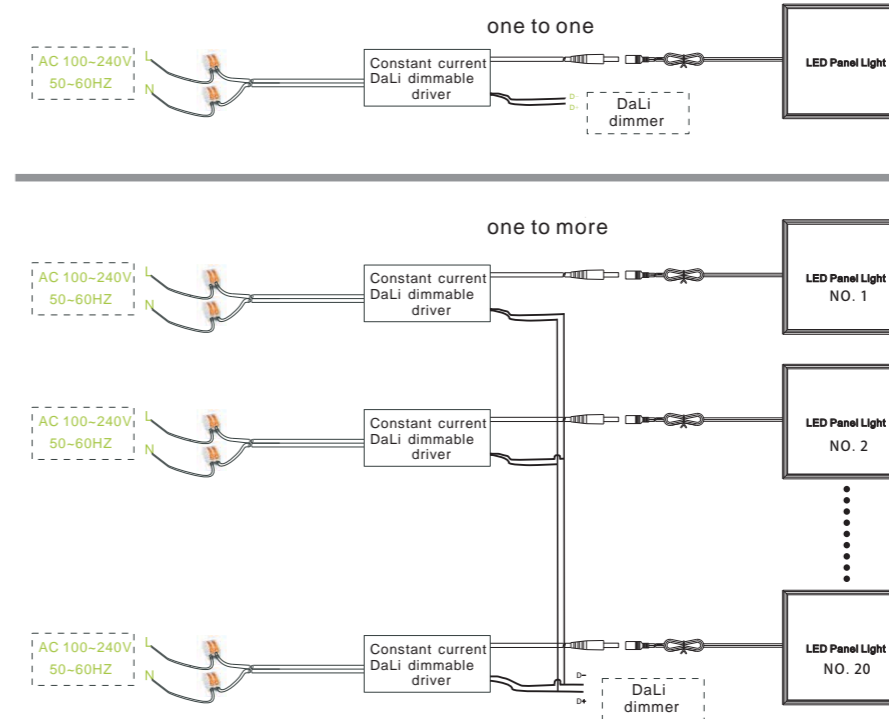

## Dimmable panel light

Signcomplex has three dimmable versions of LED panel light: 0-10V, Dall and Triac, just simply replace the regular driver with dimmable driver.

### Triac Driver Electrical Connection

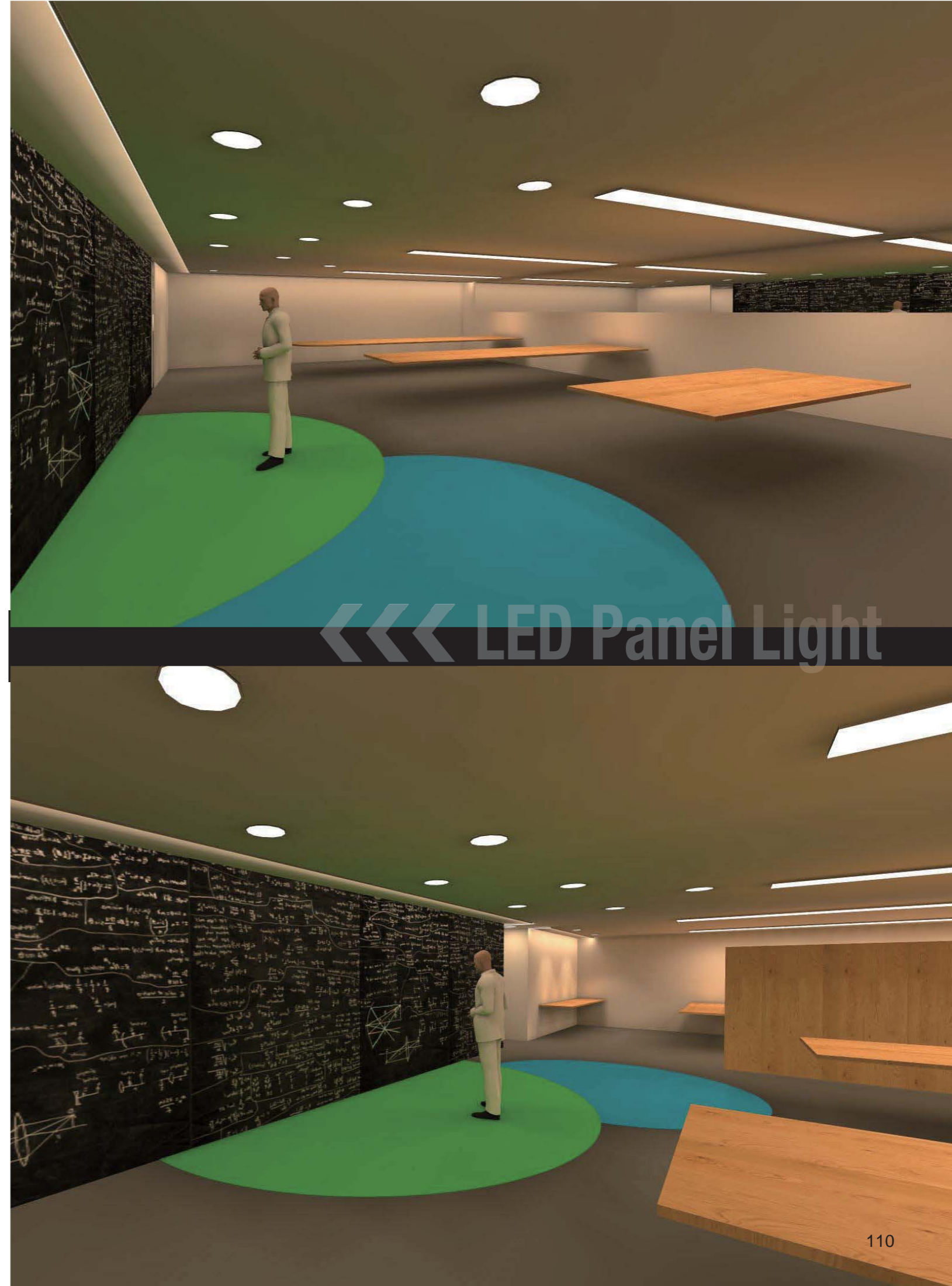
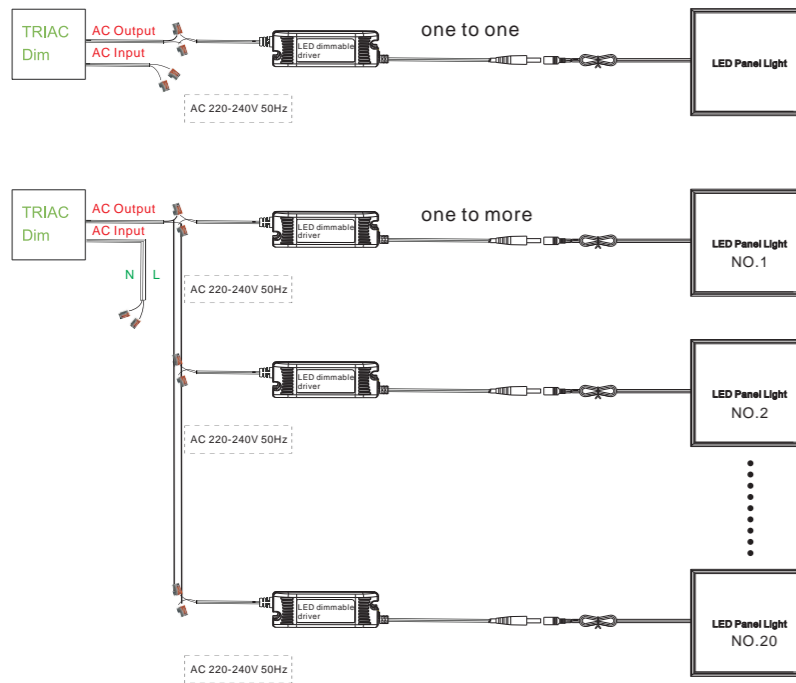

LED Panel Light

# LED Security Light



■ LED Security Light ..... 113-114

# LED Motion Security Lights



Excellent thermal design with plastic-packed aluminum structure

High quality COB leds with uniform illumination

Motion sensor adjustable lux, and sensing distance, time can be set by customer



Double LED security light



Single LED security light



Size:(mm/inch) 10W

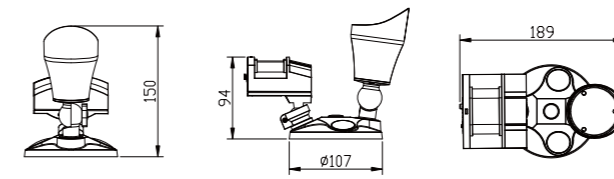

Size:(mm/inch) 20W

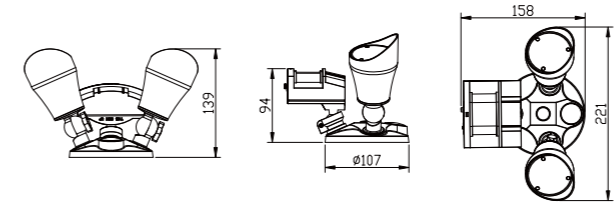

Size:(mm/inch) 30W

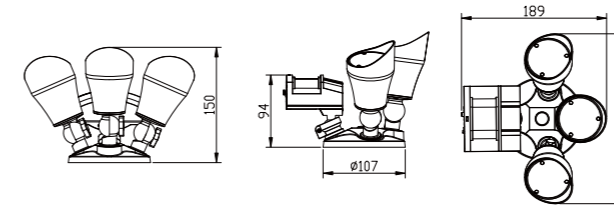

Model number	CCT	Light output (±10%)lm	CRI
SEC-010-AW-WW	2800-3100K	955	≥80
SEC-010-AW-NW	3800-4250K	975	≥80
SEC-010-AW-W	4750-5300K	985	≥80

Model number	CCT	Light output (±10%)lm	CRI
SEC-020-AW-WW	2800-3100K	1910	≥80
SEC-020-AW-NW	3800-4250K	1950	≥80
SEC-020-AW-W	4750-5300K	1970	≥80

Model number	CCT	Light output (±10%)lm	CRI
SEC-030-AW-WW	2800-3100K	2865	≥80
SEC-030-AW-NW	3800-4250K	2925	≥80
SEC-030-AW-W	4750-5300K	2955	≥80

# Emergency Light



- Emergency Camping Light ..... 117-120
- Emergency Downlight ..... 121-122
- LED Exit Sign ..... 123-126

# LED waterproof emergency camping light & Powerbank ECL4

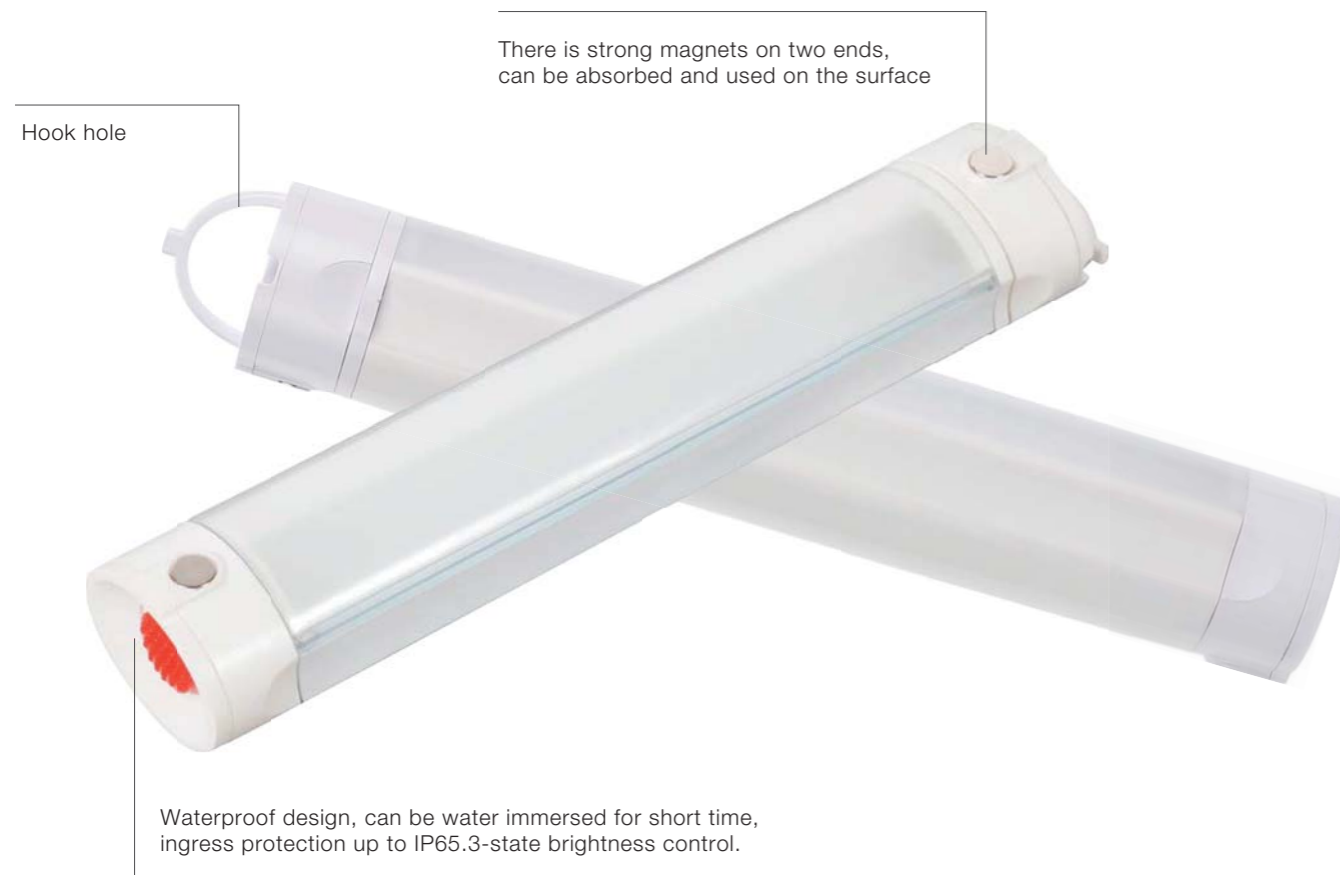

Size:(mm/inch)

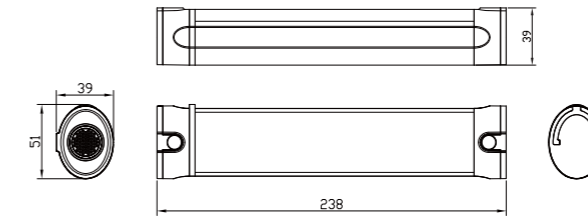

**Lighting time (full charge state)**

20% bright	>10 H
50% bright	>4 H
100% bright	>2.5 H
Flash	>5 H
SOS mode	>7.5 H

**Charging time of mobile device (full charge state)**

iphone6s (1715mAh)	>1.5 Times
iphone6s Plus (2750mAh)	>1.0 Times
HUAWEI P9 (3400mAh)	>1.0 Times
20% bright	>100 Lm
50% bright	>200 Lm
100% bright	>400 Lm



# LED Emergency Camping Light ECL3



Size:(mm/inch)

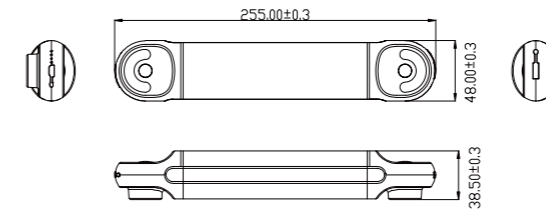

Lighting time (full charge state)

10% bright	>4.5H
50% bright	>7H
100% bright	>43H
SOS mode	>15H

Charging time of mobile device (full charge state)

iphone6s (1715mAh)	>2Times
iphone6s Plus (2750mAh)	>1.5Times
HUAWEI P9 (3400mAh)	>1.0Times
10% bright	>300Lm
50% bright	>150Lm
100% bright	>30Lm

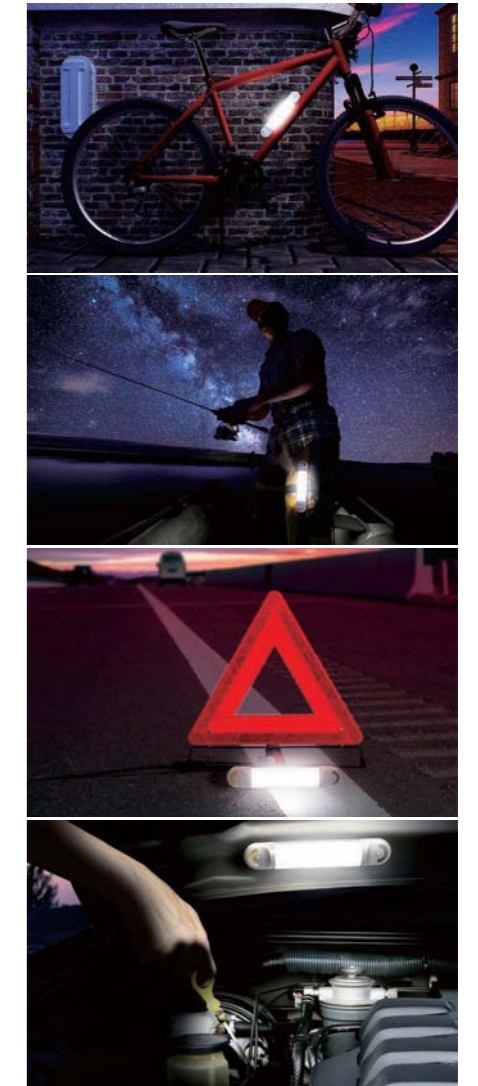

Surface installation:



# LED Emergency Downlight



There are different designs available:



Illumination of escape routes

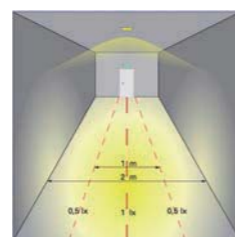

Illumination of open area >60mm<sup>2</sup> (anti-panic illumination)

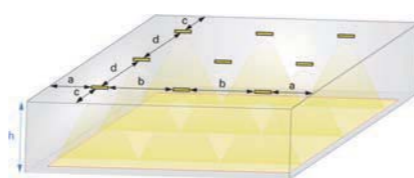

## Standard Feature

- Flame retardant ABS housing and Polycarbonate lens
- Oval Lens for escape route illumination
- Low spaces illuminate, from 2 to 6m height
- Embedded mounting (recessed ceiling mounting)
- LED: SMD XML , 6000K
- IP20 ingress protection
- ENEC, CB, CE, SAA certification, Rosh compliance
- Over charge and over discharge protection
- Working/fault status bi-color indicator and test button
- Fault self- diagnostics test and alert function

## Electrical Feature

- Input voltage: 220-240VAC 50/60Hz
- Power consumption: 6W/4W/3.5W
- LED power: 2.4W/2.5W
- Operate: ACEG, Maintained and Non-maintained
- Test: Button self-test +Auto self-test
- Battery: Self contained Li-ion/Ni-MH battery
- Charge time: 24hours and 16hours for SAA
- Discharge duration: 1hour, 2hours, 3hours

Size:(mm/inch)

EMD1N / EMD1W

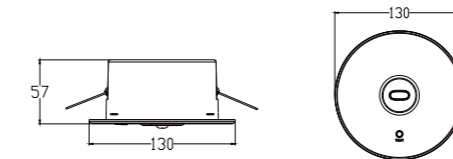

EMD3N / EMD3W

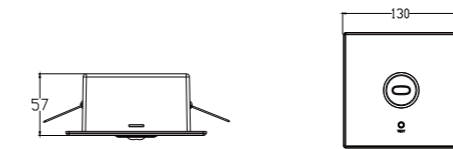

EMD5

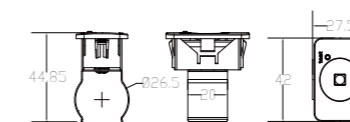

EMD6D

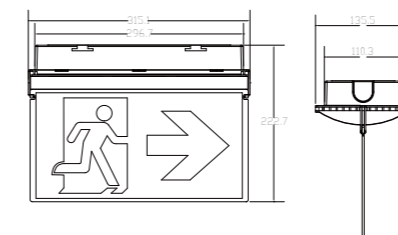

EMD8D

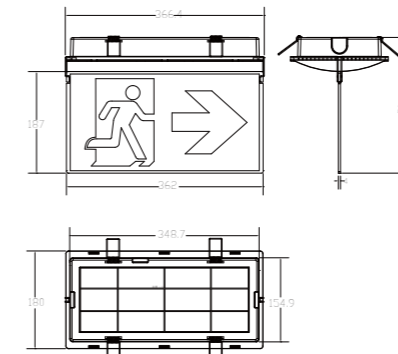

EMD2N / EMD2W



EMD4N / EMD4W

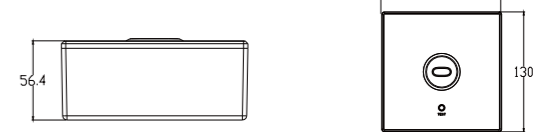

EMD6 / EMD6S

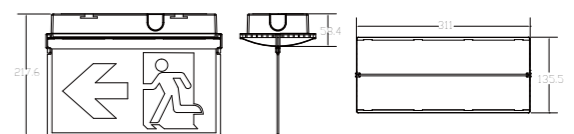

EMD7

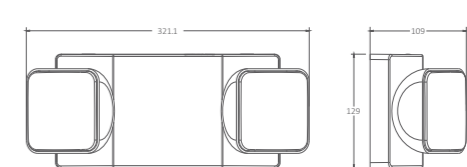

EMD8 / EMD8S

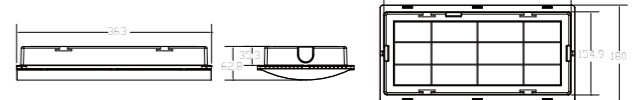

EMD9

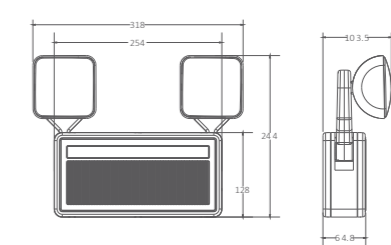



# LED Exit Sign



There are different designs available:



Pictogram Insert Feature:

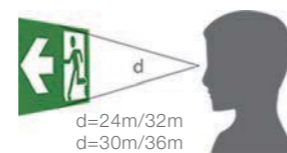

## Standard Feature

- Compact and decorative design
- Injection molded Flame retardant ABS housing
- Quick connection and easy installation
- Single and double face universal
- LED bright SMD 2835,CCT 6000K
- Li-ion or Ni-Cd or Ni-MH battery
- Replaceable pictogram design
- over charge and over discharge protection
- Working/fault status bi-color indicator and test button
- Fault self- diagnostics test and alert function
- CE, SAA certification, Rosh compliance
- Wall mounting ,Ceiling mounting, wall bracket mounting, recessed ceiling mounting

## Electrical Feature

- Input voltage:220 - 240VAC 50/60Hz
- Power consumption: 3W/4W
- Charge time: 24 hours
- Discharge duration: 1hour, 2hours, 3hours
- Test facility: Button self-test +Auto self-test
- Operation :Maintained and Non-Maintained
- Viewing distance : 24m/30m
- Flux : 32lm, 50lm
- Luminance of safety sign: >15cd/m<sup>2</sup> , >20cd/m<sup>2</sup>
- Degree of protection: IP20

Size:(mm/inch)

ESA6

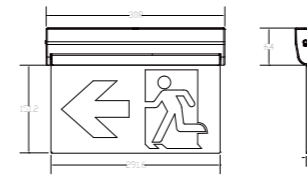

ESA8

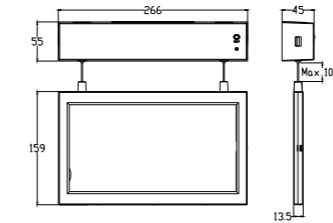

ESA10

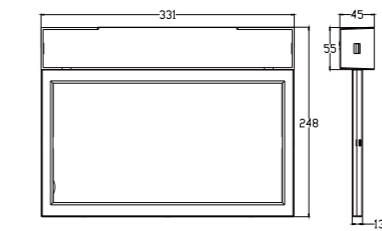

ESA12

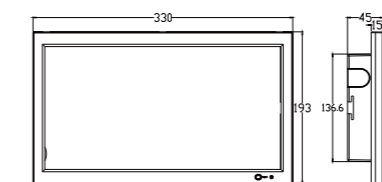

ESA7

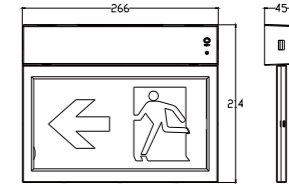

ESA9

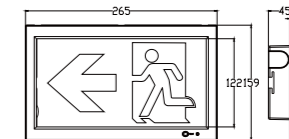

ESA11

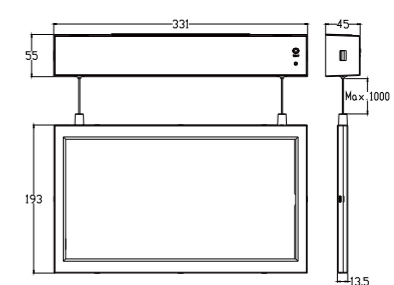

# LED Exit Sign for North America market



Injection-molded thermoplastic ABS housing

LED indicator and push button test switch

There are different designs available:

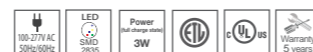

## Standard Feature

- Long listing, ultra bright white LED lamp heads
- 1W x 2 lamps heads for standard 150lm
- 1.5Wx 2 lamps heads for High-Lumen 220lm
- High performance chrome-plated metalized reflector and plastic lens for optimal light distribution
- Adjusted LED lamp heads provides optimal center-to-center spacing
- Center-to-center spacing: 20ft for standard,26ft for High-Lumen
- Energy efficient, long life red or green LED EXIT SIGN illumination

## Electrical Feature

- 100-277VAC universal voltage operation
- Low power consumption
- LED indicator and push button test switch
- Long life, maintenance-free rechargeable Li-ion battery
- 24 hours recharge after 90 minutes discharge
- Low voltage disconnect prevents battery from deep discharge
- Internal transfer switch automatically connects the battery to LED board and LED lamp heads for minimum 90-minute emergency illumination
- Remote capacity option available

Size:(mm/inch)

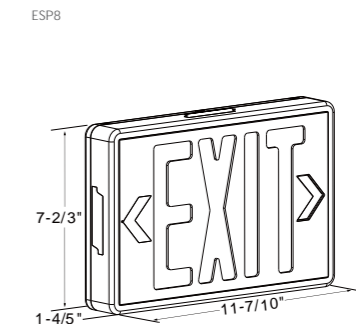
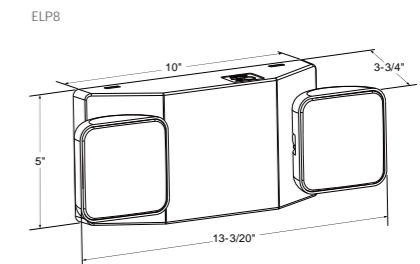
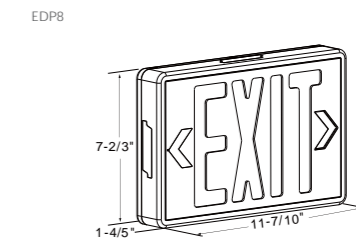
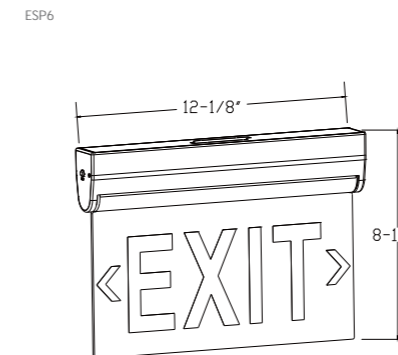
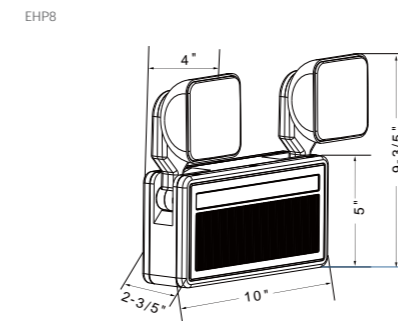
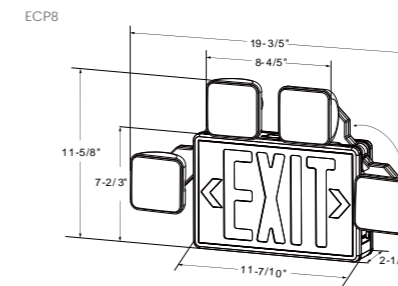

# LED Tubes



- 170LPW MT8 LED Tube ..... 129-130
- New Type MT8 Series ..... 131-132
- LT8 Nano Tube Series ..... 133-134

# 170LPW MT8 Series (High brightness)



Adopt high lumen 2835 LEDs, lighting efficiency of whole tube with milky cover can be up to be 170LM/W;  
Energy-saving, eco-friendly, no UV, IR or mercury, RoHS compliant;

Transparent or milky lamp cover, high lighting efficiency, uniform luminous surface, no dark spot;

Size:(mm)

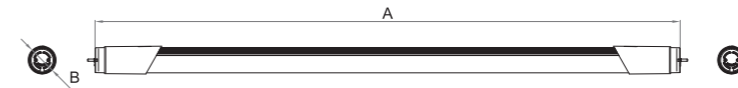

A: 0.6m=588mm 1.2m=1198mm 1.5m=1498mm  
B: 28.4mm

Model number	CCT	Light output (±10%/lm)	Length cm	CRI
MT8-009-AW-WW-16F	2800-3200K	1220	60	≥80
MT8-009-AW-NW-16F	4000-4500K	1402	60	≥80
MT8-009-AW-W-16F	5700-6300K	1366	60	≥80
MT8-009-AW-WW-16C	2800-3200K	1257	60	≥80
MT8-009-AW-NW-16C	4000-4500K	1468	60	≥80
MT8-009-AW-W-16C	5700-6300K	1422	60	≥80
-----				
MT8-012-AW-WW-16F	2800-3200K	1902	120	≥80
MT8-012-AW-NW-16F	4000-4500K	2098	120	≥80
MT8-012-AW-W-16F	5700-6300K	2034	120	≥80
MT8-012-AW-WW-16C	2800-3200K	1981	120	≥80
MT8-012-AW-NW-16C	4000-4500K	2184	120	≥80
MT8-012-AW-W-16C	5700-6300K	2118	120	≥80
-----				
MT8-015-AW-WW-17F	2800-3200K	2201	120	≥80
MT8-015-AW-NW-17F	4000-4500K	2427	120	≥80
MT8-015-AW-W-17F	5700-6300K	2353	120	≥80
MT8-015-AW-WW-17C	2800-3200K	2278	120	≥80
MT8-015-AW-NW-17C	4000-4500K	2511	120	≥80
MT8-015-AW-W-17C	5700-6300K	2436	120	≥80
-----				
MT8-018-AW-WW-17F	2800-3200K	2448	120	≥80
MT8-018-AW-NW-17F	4000-4500K	2725	120	≥80
MT8-018-AW-W-17F	5700-6300K	2670	120	≥80
MT8-018-AW-WW-17C	2800-3200K	2624	120	≥80
MT8-018-AW-NW-17C	4000-4500K	2857	120	≥80
MT8-018-AW-W-17C	5700-6300K	2827	120	≥80
-----				
MT8-022-AW-WW-16F	2800-3200K	3053	150	≥80
MT8-022-AW-NW-16F	4000-4500K	3463	150	≥80
MT8-022-AW-W-16F	5700-6300K	3469	150	≥80
MT8-022-AW-WW-16C	2800-3200K	3318	150	≥80
MT8-022-AW-NW-16C	4000-4500K	3823	150	≥80
MT8-022-AW-W-16C	5700-6300K	3725	150	≥80

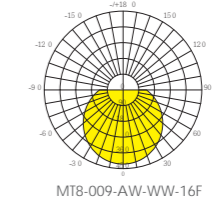

MT8-009-AW-WW-16F

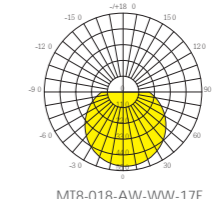

MT8-012-AW-WW-17F

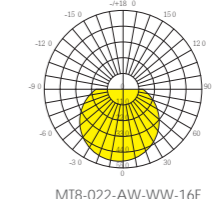

MT8-022-AW-WW-16F



# New Type MT8 Series



CRI > 80, CE and RoHS compliant, PF > 0.95,  
no glare, no interference, human body induction.

Long lifetime, energy-saving, high bright,  
high efficiency thermal management, high lumen,  
5 years warranty, highly cost-effective.

Size:(mm)

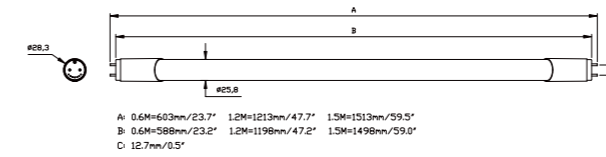

Model number	CCT	Light output (±10%)lm	Length cm	CRI
<b>Frosted (High brightness)</b>				
MT8-009-AW-WW-03F	2800-3200K	1011	60	≥80
MT8-009-AW-NW-03F	4000-4500K	1018	60	≥80
MT8-009-AW-W-03F	5700-6300K	1090	60	≥80
MT8-018-AW-WW-04F	2800-3200K	1976	120	≥80
MT8-018-AW-NW-04F	4000-4500K	2057	120	≥80
MT8-018-AW-W-04F	5700-6300K	2151	120	≥80
MT8-022-AW-WW-02F	2800-3200K	2408	150	≥80
MT8-022-AW-NW-02F	4000-4500K	2591	150	≥80
MT8-022-AW-W-02F	5700-6300K	2771	150	≥80
<b>Clear (High brightness)</b>				
MT8-009-AW-WW-01C	2800-3200K	1167	60	≥80
MT8-009-AW-NW-01C	4000-4500K	1149	60	≥80
MT8-009-AW-W-01C	5700-6300K	1257	60	≥80
MT8-018-AW-WW-01C	2800-3200K	2258	120	≥80
MT8-018-AW-NW-01C	4000-4500K	2355	120	≥80
MT8-018-AW-W-01C	5700-6300K	2431	120	≥80
MT8-022-AW-WW-01C	2800-3200K	2888	150	≥80
MT8-022-AW-NW-01C	4000-4500K	2779	150	≥80
MT8-022-AW-W-01C	5700-6300K	3139	150	≥80
<b>Frosted (Normal brightness)</b>				
MT8-009-AW-WW-04F	2800-3200K	788	60	≥80
MT8-009-AW-NW-04F	4000-4500K	874	60	≥80
MT8-009-AW-W-04F	5700-6300K	858	60	≥80
MT8-018-AW-WW-05F	2800-3200K	1701	120	≥80
MT8-018-AW-NW-05F	4000-4500K	1873	120	≥80
MT8-018-AW-W-05F	5700-6300K	1894	120	≥80
MT8-022-AW-WW-03F	2800-3200K	1997	150	≥80
MT8-022-AW-NW-03F	4000-4500K	2250	150	≥80
MT8-022-AW-W-03F	5700-6300K	2340	150	≥80
<b>Clear (Normal brightness)</b>				
MT8-009-AW-WW-02C	2800-3200K	891	60	≥80
MT8-009-AW-NW-02C	4000-4500K	987	60	≥80
MT8-009-AW-W-02C	5700-6300K	986	60	≥80
MT8-018-AW-WW-02C	2800-3200K	1867	120	≥80
MT8-018-AW-NW-02C	4000-4500K	2066	120	≥80
MT8-018-AW-W-02C	5700-6300K	2078	120	≥80
MT8-022-AW-WW-02C	2800-3200K	2326	150	≥80
MT8-022-AW-NW-02C	4000-4500K	2550	150	≥80
MT8-022-AW-W-02C	5700-6300K	2541	150	≥80

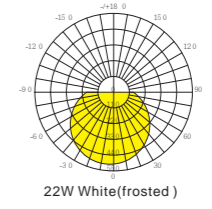
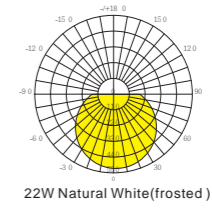
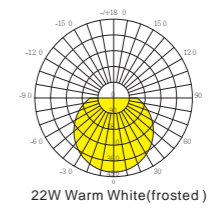

# Nano Tube LT8 Series



New Nano-technology housing,  
better for cooling and light efficiency

tube features high compatibility and high-temperature resistant

Size:(mm)

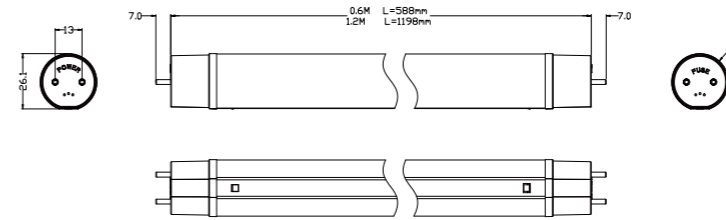

Model number	CCT	Light output (±10%/lm)	Length mm	CRI
<b>Frosted (High brightness)</b>				
LT8-009-AW-WW-07F	2800-3200K	1049	60	>80
LT8-009-AW-NW-07F	4000-4500K	1162	60	>80
LT8-009-AW-W-07F	5700-6300K	1117	60	>80
LT8-018-AW-WW-07F	2800-3200K	1933	120	>80
LT8-018-AW-NW-07F	4000-4500K	2195	120	>80
LT8-018-AW-W-07F	5700-6300K	2075	120	>80

<b>Frosted(High Normal brightness)</b>				
LT8-009-AW-WW-08F	2800-3200K	874	60	>80
LT8-009-AW-NW-08F	4000-4500K	984	60	>80
LT8-009-AW-W-08F	5700-6300K	960	60	>80
LT8-018-AW-WW-08F	2800-3200K	1675	120	>80
LT8-018-AW-NW-08F	4000-4500K	1872	120	>80
LT8-018-AW-W-08F	5700-6300K	1873	120	>80

**\*\* No flicker ST8 Series**

Model number	CCT	Light output (±10%/lm)	Length mm	CRI
<b>Frosted (High brightness)</b>				
LT8-009-AW-WW-12F	2800-3200K	914	60	>80
LT8-009-AW-NW-12F	4000-4500K	1008	60	>80
LT8-009-AW-W-12F	5700-6300K	965	60	>80
LT8-010-AW-WW-01F	2800-3200K	1309	120	>80
LT8-010-AW-NW-01F	4000-4500K	1447	120	>80
LT8-010-AW-W-01F	5700-6300K	1406	120	>80
LT8-015-AW-WW-01F	2800-3200K	1885	120	>80
LT8-015-AW-NW-01F	4000-4500K	2083	120	>80
LT8-015-AW-W-01F	5700-6300K	2024	120	>80
LT8-018-AW-WW-12F	2800-3200K	2277	120	>80
LT8-018-AW-NW-12F	4000-4500K	2516	120	>80
LT8-018-AW-W-12F	5700-6300K	2445	120	>80

<b>Frosted(High Normal brightness)</b>				
LT8-009-AW-WW-13F	2800-3200K	769	60	>80
LT8-009-AW-NW-13F	4000-4500K	870	60	>80
LT8-009-AW-W-13F	5700-6300K	862	60	>80
LT8-010-AW-WW-02F	2800-3200K	1134	120	>80
LT8-010-AW-NW-02F	4000-4500K	1284	120	>80
LT8-010-AW-W-02F	5700-6300K	1269	120	>80
LT8-015-AW-WW-02F	2800-3200K	1445	120	>80
LT8-015-AW-NW-02F	4000-4500K	1635	120	>80
LT8-015-AW-W-02F	5700-6300K	1617	120	>80
LT8-018-AW-WW-13F	2800-3200K	1742	120	>80
LT8-018-AW-NW-13F	4000-4500K	1972	120	>80
LT8-018-AW-W-13F	5700-6300K	1949	120	>80



# LED Tubes



Industrial Area / Office Building / Ground Floor / Calculation surface 3 / Isolines/Horizontal illuminance  
 Calculation surface 3 / Isolines/Horizontal illuminance

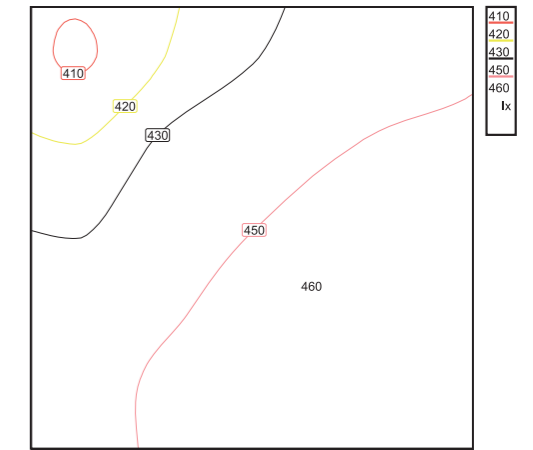

Scale: 1 : 10  
 Horizontal illuminance (Grid)  
 Average: 446 lx, Min: 409 lx, Max: 475 lx, Min/average: 0.917,  
 Min/max: 0.861, Points: 5 x 5 (Relevant: all)

Scale: 1 : 10

Industrial Area / Office Building / Ground Floor / Calculation surface 3 / False colours/Horizontal illuminance

Calculation surface 3 / False colours/Horizontal illuminance



Horizontal illuminance (Grid)  
 Average: 446 lx, Min: 409 lx, Max: 475 lx, Min/average: 0.917,  
 Min/max: 0.861, Points: 5 x 5 (Relevant: all)

# LINEAR LIGHT



■ SL8060	.....	139-140
■ SL5550	.....	141-142
■ SL9070	.....	143-144
■ SL8456	.....	145-146
■ SL8050	.....	147-150
■ SL10075	.....	151-154
■ SL11070	.....	155-158
■ HL1919/HL1935	.....	159-160
■ HL4040	.....	161-164
■ SL7250	.....	165-166
■ RL4932	.....	167-168
■ RL7035	.....	169-170
■ RL13054	.....	171-172



# Linear light SL8060

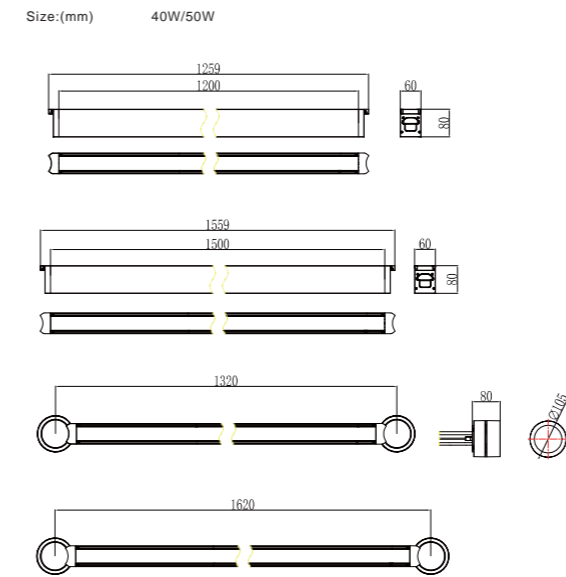
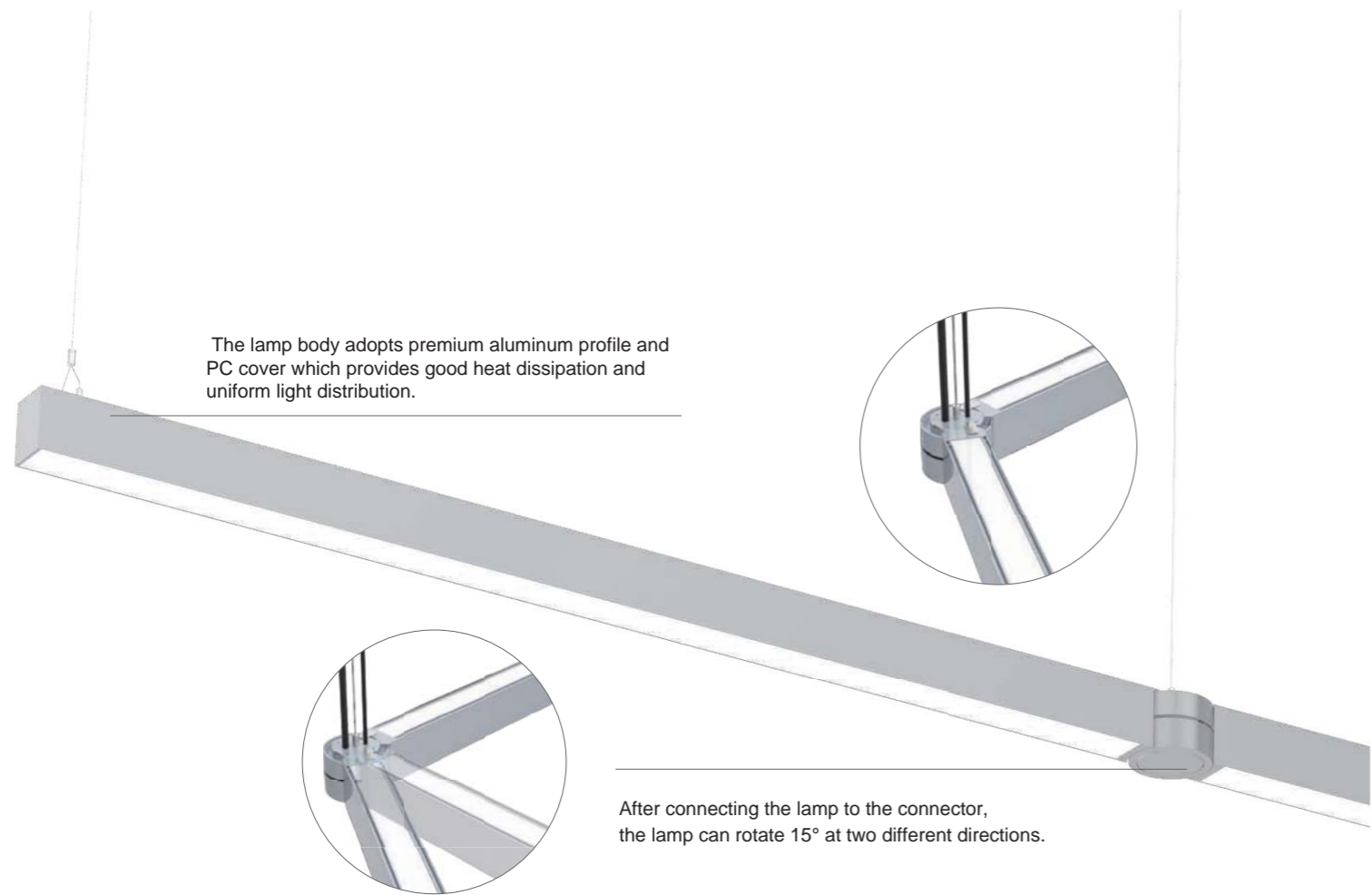

Model number	CCT	Light output (±10%)lm	Length mm	CRI
SC-SL8060-040-AW-CW	6000-6500K	3760	1259	≥80
SC-SL8060-040-AW-NW	3800-4200K	3760	1259	≥80
SC-SL8060-040-AW-WW	2800-3200K	3320	1259	≥80
SC-SL8060-050-AW-CW	6000-6500K	4700	1559	≥80
SC-SL8060-050-AW-NW	3800-4200K	4700	1559	≥80
SC-SL8060-050-AW-WW	2800-3200K	4150	1559	≥80

Flexibility of lighting design, more imaginary shapes

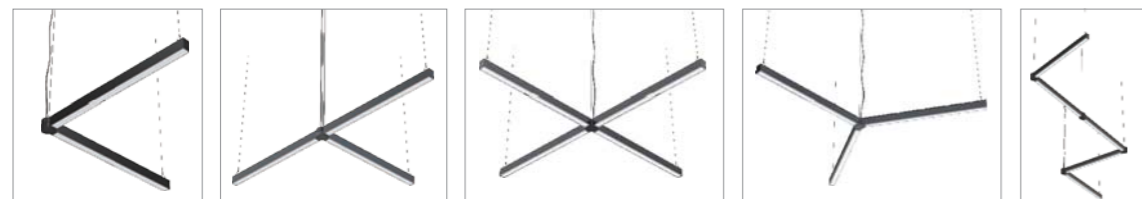

# Linear light SL5550 trunking system



The light body adopts split type design. The light body and track use stainless steel 301 Shrapnel for connection.

Adoption of aluminum alloy section + PMMA lens, surface powder coating technology

The track adopts splicing design, which allows continuous connection, MAX 6000W(120M long); The track is tensioned with spring buckles to realize seamless connection.

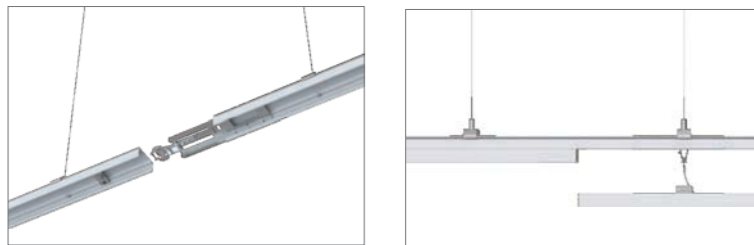

Various installation: Suspendent ceiling and recessed.

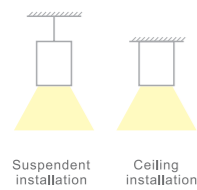

Light distribution curve

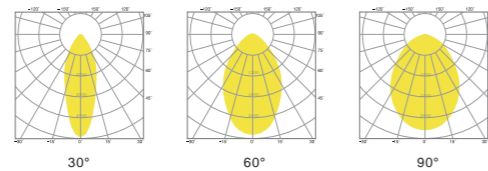

Size:(mm) 50W/65W non-dimmable

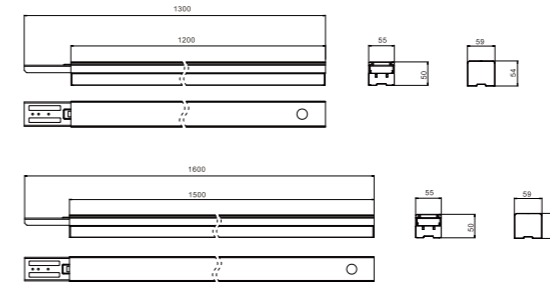

Model number	CCT	Light output (±10%)lm	Length mm	CRI
SC-SL5550-050-AW-CW	6000-6500K	6000	1200	≥80
SC-SL5550-050-AW-NW	3800-4200K	6250	1200	≥80
SC-SL5550-050-AW-WW	2800-3200K	5750	1200	≥80
SC-SL5550-065-AW-CW	6000-6500K	7800	1500	≥80
SC-SL5550-065-AW-NW	3800-4200K	8125	1500	≥80
SC-SL5550-065-AW-WW	2800-3200K	7475	1500	≥80

Size:(mm) 50W/65W 0-10V dimming

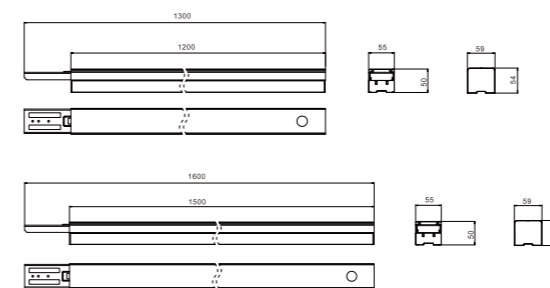

Model number	CCT	Light output (±10%)lm	Length mm	CRI
SC-SL5550-050-AW-A01-CW	6000-6500K	6000	1200	≥80
SC-SL5550-050-AW-A01-NW	3800-4200K	6250	1200	≥80
SC-SL5550-050-AW-A01-WW	2800-3200K	5750	1200	≥80
SC-SL5550-065-AW-A01-CW	6000-6500K	7800	1500	≥80
SC-SL5550-065-AW-A01-NW	3800-4200K	8125	1500	≥80
SC-SL5550-065-AW-A01-WW	2800-3200K	7475	1500	≥80

Size:(mm) 50W/65W Dali dimming

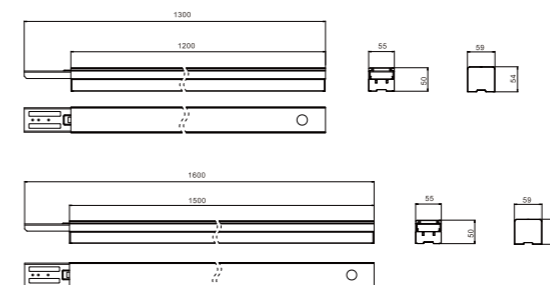

Model number	CCT	Light output (±10%)lm	Length mm	CRI
SC-SL5550-050-AW-D01-CW	6000-6500K	6000	1200	≥80
SC-SL5550-050-AW-D01-NW	3800-4200K	6250	1200	≥80
SC-SL5550-050-AW-D01-WW	2800-3200K	5750	1200	≥80
SC-SL5550-065-AW-D01-CW	6000-6500K	7800	1500	≥80
SC-SL5550-065-AW-D01-NW	3800-4200K	8125	1500	≥80
SC-SL5550-065-AW-D01-WW	2800-3200K	7475	1500	≥80

# Linear light SL9070 LED linear trunking system

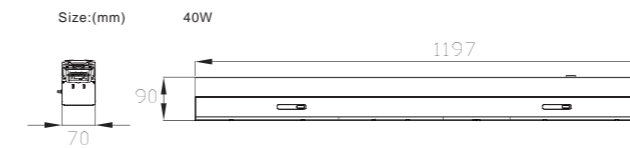
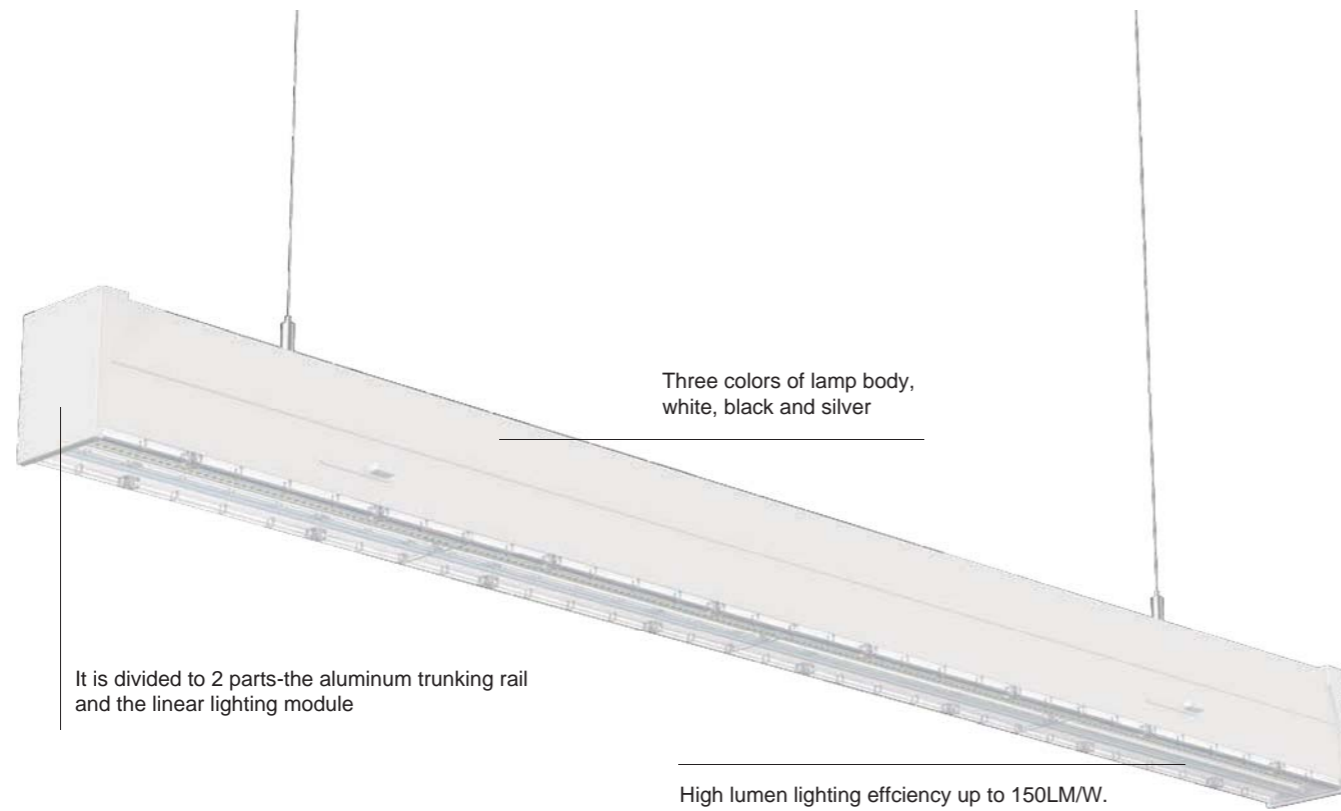

Model number	CCT	Light output (±10%)lm	Length mm	CRI
SC-SL9070-040-AW-CW	5500-6500K	6105	1200	≥80
SC-SL9070-040-AW-NW	3900-4500K	5810	1200	≥80
SC-SL9070-040-AW-WW	2700-3200K	5530	1200	≥80

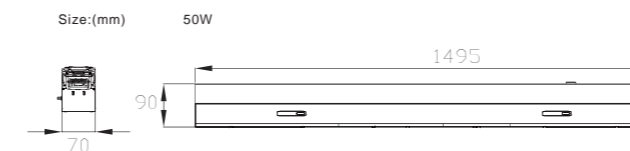

Model number	CCT	Light output (±10%)lm	Length mm	CRI
SC-SL9070-050-AW-CW	5500-6500K	7400	1500	≥80
SC-SL9070-050-AW-NW	3900-4500K	6800	1500	≥80
SC-SL9070-050-AW-WW	2700-3200K	6600	1500	≥80

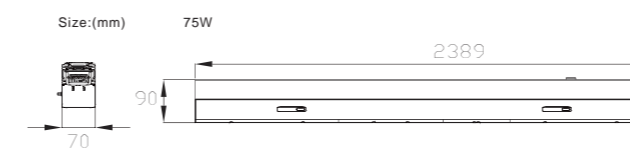

Model number	CCT	Light output (±10%)lm	Length mm	CRI
SC-SL9070-075-AW-CW	5500-6500K	10500	2400	≥80
SC-SL9070-075-AW-NW	3900-4500K	10010	2400	≥80
SC-SL9070-075-AW-WW	2700-3200K	9520	2400	≥80

The trunking rail with built-in connection accessories, to connect the electrical parts and structure.



With 3 phase and 4 wires electrical circuit design, pre-mounted 5/7 wires with 2.5mm<sup>2</sup> copper core. The max continuous run is up to 250m at 220VAC and 110m at 110VAC.



Various installation: suspending, ceiling and recessed

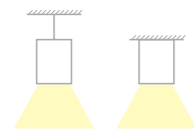

Suspending installation Ceiling installation



# Linear light SL8456

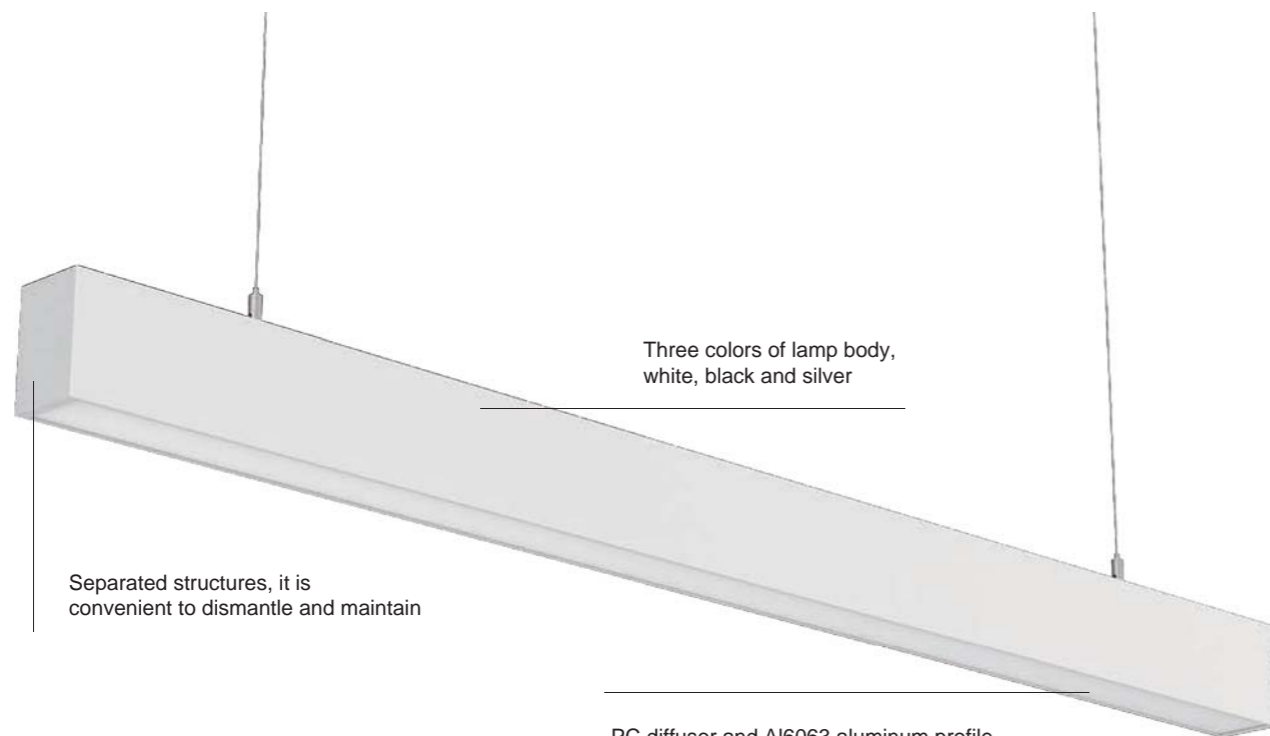

Three colors of lamp body, white, black and silver

Separated structures, it is convenient to dismantle and maintain

PC diffuser and Al6063 aluminum profile, with good heat distribution and high light efficiency.

The product can operate in single run or continuous runs seamless, when input voltage is AC220V, 110m can be connected; when input voltage is 110V, 60m can be connected.



The lamp and power supply is connected with high-voltage live part via connector; it is very convenient to install and disassemble, and it is also safe and reliable to use



Multiple jointing can realized via "+" "L" shape connecting accessories

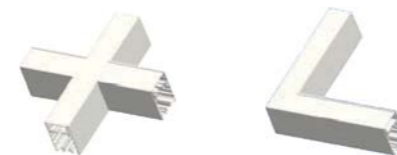

Various installation: suspending, ceiling and recessed

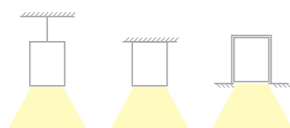

Suspension installation Ceiling installation Embedded installation

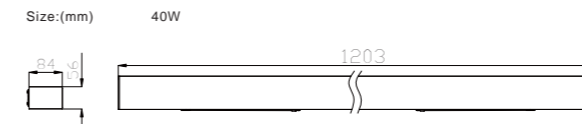

Model number	CCT	Light output (±10%)lm	Length mm	CRI
SC-SL8456-040-AW-CW	5500-6500K	3780	1200	≥80
SC-SL8456-040-AW-NW	3900-4500K	4030	1200	≥80
SC-SL8456-040-AW-WW	2700-3200K	3650	1200	≥80

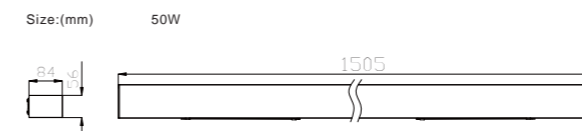

Model number	CCT	Light output (±10%)lm	Length mm	CRI
SC-SL8456-050-AW-CW	5500-6500K	4640	1500	≥80
SC-SL8456-050-AW-NW	3900-4500K	4600	1500	≥80
SC-SL8456-050-AW-WW	2700-3200K	4090	1500	≥80

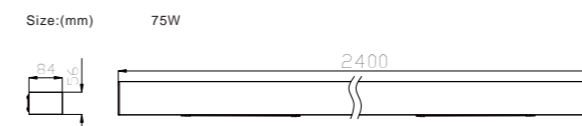

Model number	CCT	Light output (±10%)lm	Length mm	CRI
SC-SL8456-075-AW-CW	5500-6500K	6400	2400	≥80
SC-SL8456-075-AW-NW	3900-4500K	6650	2400	≥80
SC-SL8456-075-AW-WW	2700-3200K	5950	2400	≥80

# Linear light SL8050 in single run

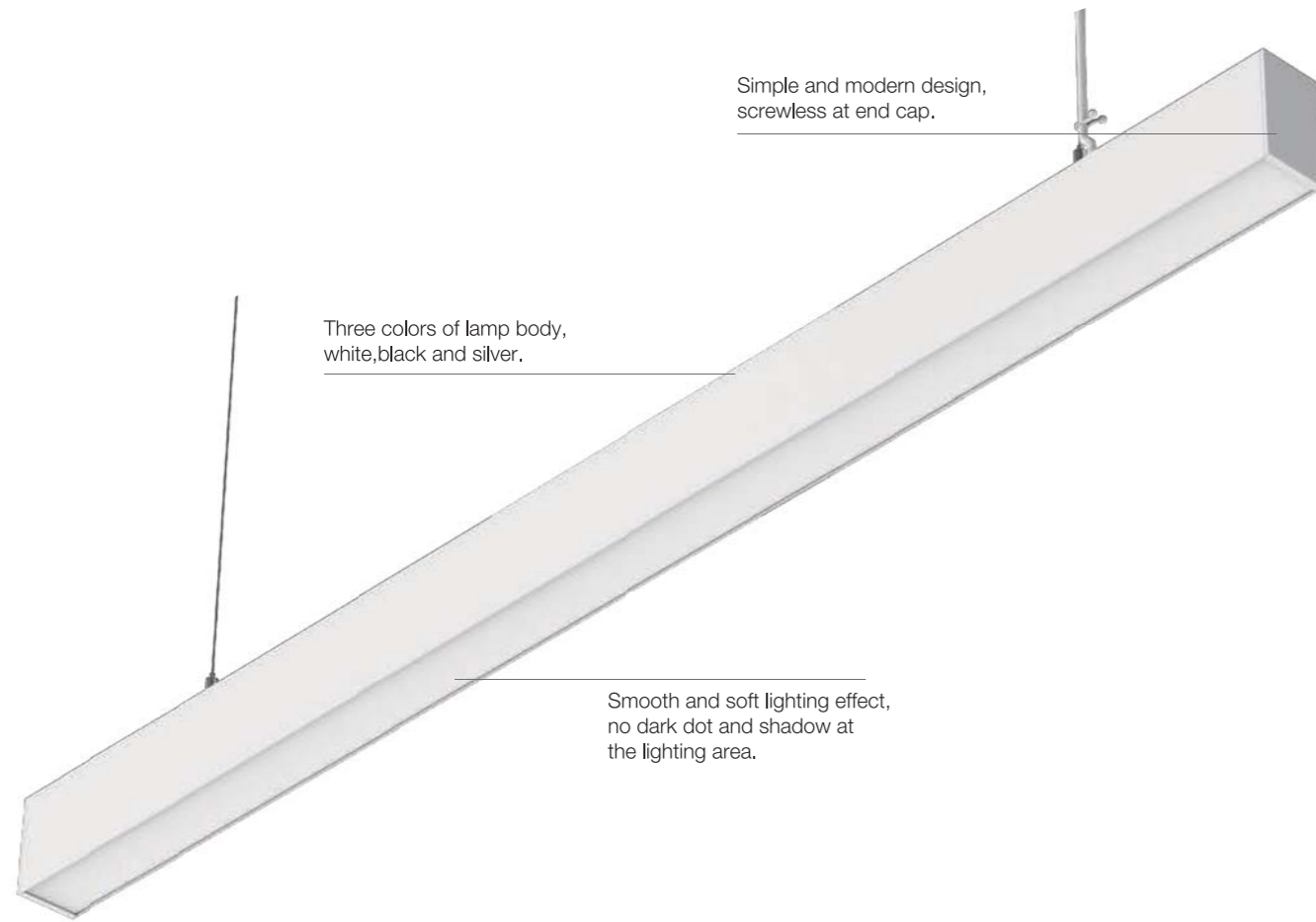

Size:(mm)

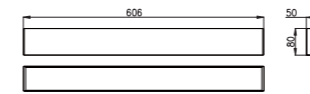

Model number	CCT	Light output (±10%)lm	Length mm	CRI
SC-SL8050-018-AW-01WW	2700-3200K	1650	606	≥80
SC-SL8050-018-AW-01NW	3900-4500K	1620	606	≥80
SC-SL8050-018-AW-01CW	5500-6500K	1656	606	≥80

Size:(mm)

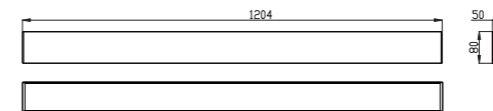

Model number	CCT	Light output (±10%)lm	Length mm	CRI
SC-SL8050-036-AW-01WW	2700-3200K	3060	1204	≥80
SC-SL8050-036-AW-01NW	3900-4500K	3240	1204	≥80
SC-SL8050-036-AW-01CW	5500-6500K	3310	1204	≥80

Size:(mm)

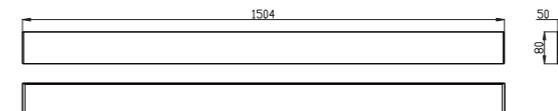

Model number	CCT	Light output (±10%)lm	Length mm	CRI
SC-SL8050-045-AW-01WW	2700-3200K	3825	1504	≥80
SC-SL8050-045-AW-01NW	3900-4500K	4050	1504	≥80
SC-SL8050-045-AW-01CW	5500-6500K	4140	1504	≥80

Various installation: suspndent, ceiling and recessed

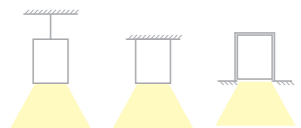

Suspndent installation Ceiling installation Embedded Installation



# Linear light SL8050 in continuous run

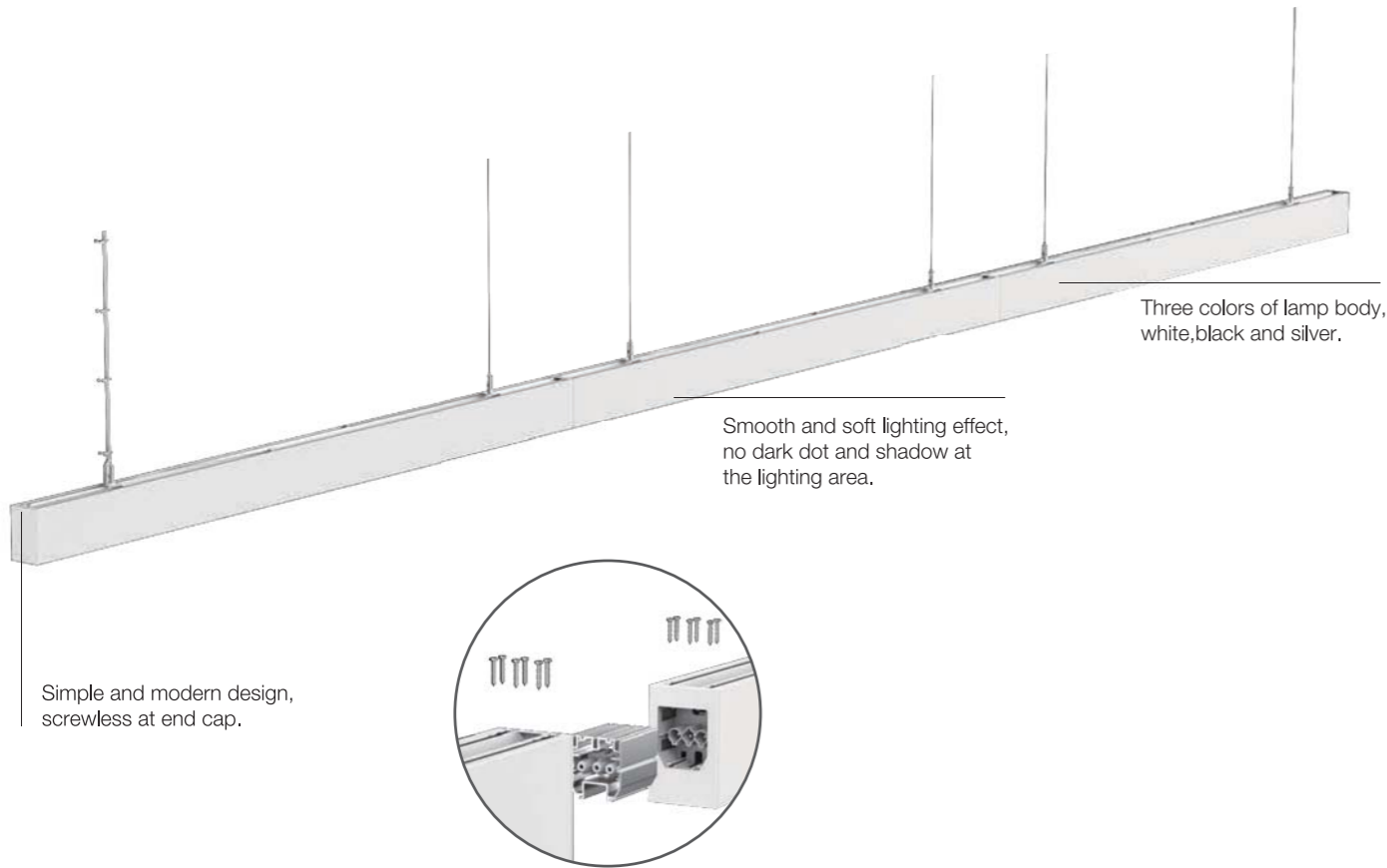

Size:(mm)

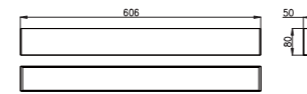

	Model number	CCT	Light output (±10%)lm	Length mm	CRI
First Run	SC-SL8050-018-AW-02WW	2700-3200K	1530	606	≥80
	SC-SL8050-018-AW-02NW	3900-4500K	1620	606	≥80
	SC-SL8050-018-AW-02CW	5500-6500K	1650	606	≥80
Middle Run	SC-SL8050-018-AW-03WW	2700-3200K	1530	606	≥80
	SC-SL8050-018-AW-03NW	3900-4500K	1620	606	≥80
	SC-SL8050-018-AW-03CW	5500-6500K	1650	606	≥80
Last Run	SC-SL8050-018-AW-04WW	2700-3200K	1530	606	≥80
	SC-SL8050-018-AW-04NW	3900-4500K	1620	606	≥80
	SC-SL8050-018-AW-04CW	5500-6500K	1650	606	≥80

Size:(mm)

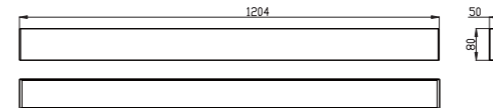

	Model number	CCT	Light output (±10%)lm	Length mm	CRI
First Run	SC-SL8050-036-AW-02WW	2700-3200K	3060	1204	≥80
	SC-SL8050-036-AW-02NW	3900-4500K	3240	1204	≥80
	SC-SL8050-036-AW-02CW	5500-6500K	3310	1204	≥80
Middle Run	SC-SL8050-036-AW-03WW	2700-3200K	3060	1204	≥80
	SC-SL8050-036-AW-03NW	3900-4500K	3240	1204	≥80
	SC-SL8050-036-AW-03CW	5500-6500K	3310	1204	≥80
Last Run	SC-SL8050-036-AW-04WW	2700-3200K	3060	1204	≥80
	SC-SL8050-036-AW-04NW	3900-4500K	3240	1204	≥80
	SC-SL8050-036-AW-04CW	5500-6500K	3310	1204	≥80

Size:(mm)

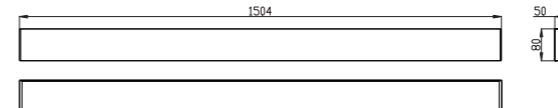

	Model number	CCT	Light output (±10%)lm	Length mm	CRI
First Run	SC-SL8050-045-AW-02WW	2700-3200K	3820	1504	≥80
	SC-SL8050-045-AW-02NW	3900-4500K	4050	1504	≥80
	SC-SL8050-045-AW-02CW	5500-6500K	4140	1504	≥80
Middle Run	SC-SL8050-045-AW-03WW	2700-3200K	3820	1504	≥80
	SC-SL8050-045-AW-03NW	3900-4500K	4050	1504	≥80
	SC-SL8050-045-AW-03CW	5500-6500K	4140	1504	≥80
Last Run	SC-SL8050-045-AW-04WW	2700-3200K	3820	1504	≥80
	SC-SL8050-045-AW-04NW	3900-4500K	4050	1504	≥80
	SC-SL8050-045-AW-04CW	5500-6500K	4140	1504	≥80

Various installation: Suspendent, ceiling and recessed.

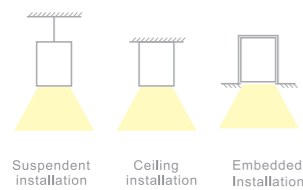

# Linear light SL10075 in single run



Simple and modern design, screwless at end cap.

Three colors of lamp body, white, black and silver.

Smooth and soft lighting effect, no dark dot and shadow at the lighting area.

Various installation: Suspendent, ceiling and recessed.

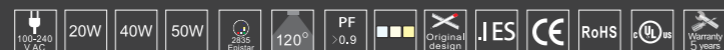
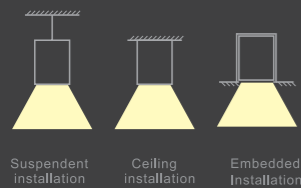

Size:(mm)

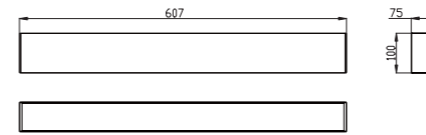

Model number	CCT	Light output (±10%)lm	Length mm	CRI
SC-SL10075-020-AW-01WW	2700-3200K	1661	607	≥80
SC-SL10075-020-AW-01NW	3900-4500K	1812	607	≥80
SC-SL10075-020-AW-01CW	5500-6500K	1732	607	≥80

Size:(mm)

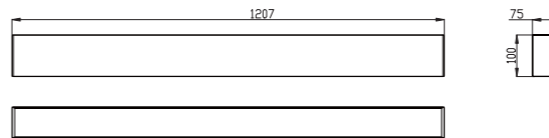

Model number	CCT	Light output (±10%)lm	Length mm	CRI
SC-SL10075-040-AW-01WW	2700-3200K	3460	1207	≥80
SC-SL10075-040-AW-01NW	3900-4500K	3557	1207	≥80
SC-SL10075-040-AW-01CW	5500-6500K	3630	1207	≥80

Size:(mm)

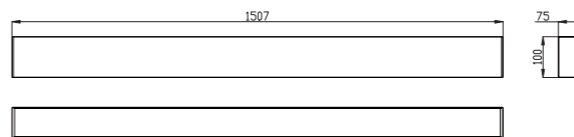

Model number	CCT	Light output (±10%)lm	Length mm	CRI
SC-SL10075-050-AW-01WW	2700-3200K	4072	1507	≥80
SC-SL10075-050-AW-01NW	3900-4500K	4491	1507	≥80
SC-SL10075-050-AW-01CW	5500-6500K	4295	1507	≥80

# Linear light SL10075 in continuous run

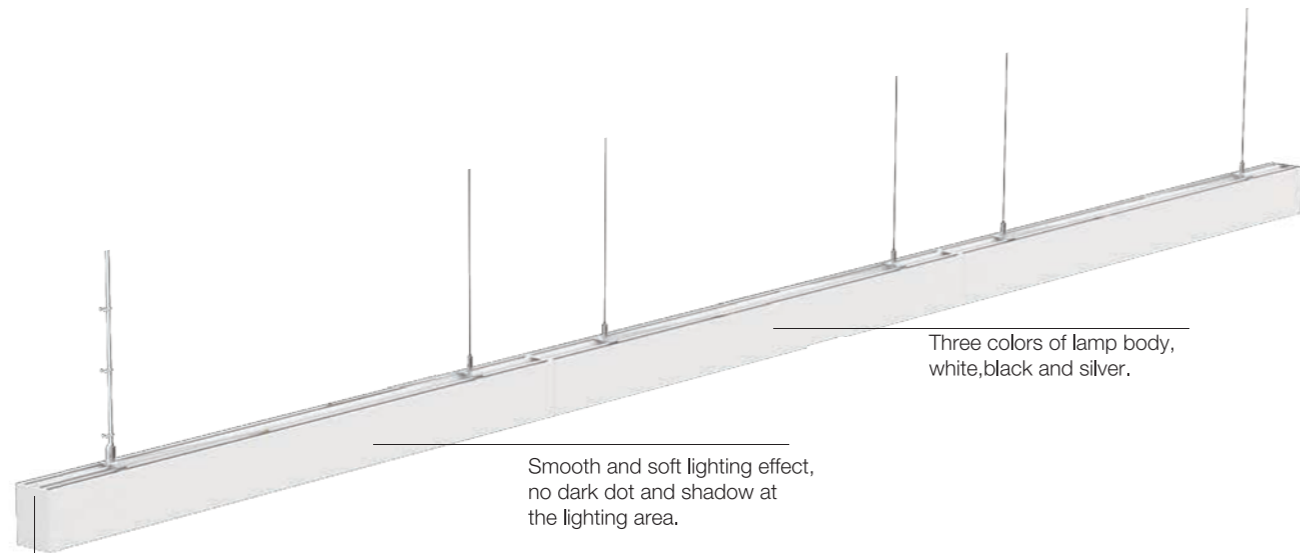

Three colors of lamp body, white, black and silver.

Smooth and soft lighting effect, no dark dot and shadow at the lighting area.

Simple and modern design, screwless at end cap.

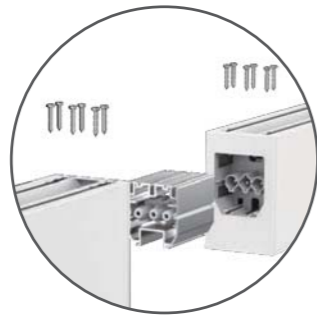

Various installation: Suspended, ceiling and recessed.

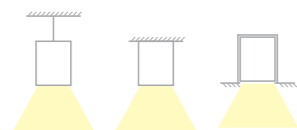

Suspended installation Ceiling installation Embedded installation



Size:(mm)

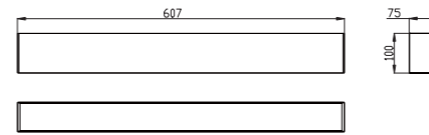

	Model number	CCT	Light output (±10%)lm	Length mm	CRI
First Run	SC-SL10075-020-AW-02WW	2700-3200K	1661	607	≥80
	SC-SL10075-020-AW-02NW	3900-4500K	1812	607	≥80
	SC-SL10075-020-AW-02CW	5500-6500K	1732	607	≥80
Middle Run	SC-SL10075-020-AW-03WW	2700-3200K	1661	607	≥80
	SC-SL10075-020-AW-03NW	3900-4500K	1812	607	≥80
	SC-SL10075-020-AW-03CW	5500-6500K	1732	607	≥80
Last Run	SC-SL10075-020-AW-04WW	2700-3200K	1661	607	≥80
	SC-SL10075-020-AW-04NW	3900-4500K	1812	607	≥80
	SC-SL10075-020-AW-04CW	5500-6500K	1732	607	≥80

Size:(mm)

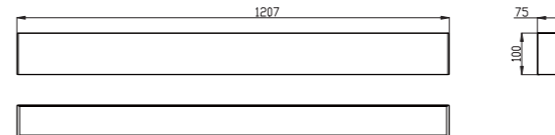

	Model number	CCT	Light output (±10%)lm	Length mm	CRI
First Run	SC-SL10075-040-AW-02WW	2700-3200K	3460	1207	≥80
	SC-SL10075-040-AW-02NW	3900-4500K	3557	1207	≥80
	SC-SL10075-040-AW-02CW	5500-6500K	3460	1207	≥80
Middle Run	SC-SL10075-040-AW-03WW	2700-3200K	3460	1207	≥80
	SC-SL10075-040-AW-03NW	3900-4500K	3557	1207	≥80
	SC-SL10075-040-AW-03CW	5500-6500K	3460	1207	≥80
Last Run	SC-SL10075-040-AW-04WW	2700-3200K	3460	1207	≥80
	SC-SL10075-040-AW-04NW	3900-4500K	3557	1207	≥80
	SC-SL10075-040-AW-04CW	5500-6500K	3460	1207	≥80

Size:(mm)

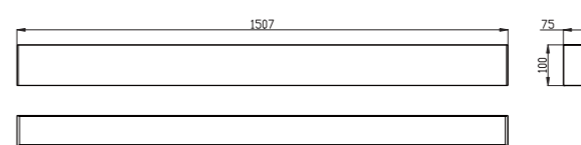

	Model number	CCT	Light output (±10%)lm	Length mm	CRI
First Run	SC-SL10075-050-AW-02WW	2700-3200K	4072	1507	≥80
	SC-SL10075-050-AW-02NW	3900-4500K	4491	1507	≥80
	SC-SL10075-050-AW-02CW	5500-6500K	4072	1507	≥80
Middle Run	SC-SL10075-050-AW-03WW	2700-3200K	4072	1507	≥80
	SC-SL10075-050-AW-03NW	3900-4500K	4491	1507	≥80
	SC-SL10075-050-AW-03CW	5500-6500K	4072	1507	≥80
Last Run	SC-SL10075-050-AW-04WW	2700-3200K	4072	1507	≥80
	SC-SL10075-050-AW-04NW	3900-4500K	4491	1507	≥80
	SC-SL10075-050-AW-04CW	5500-6500K	4072	1507	≥80



# Linear light SL11070 in single run

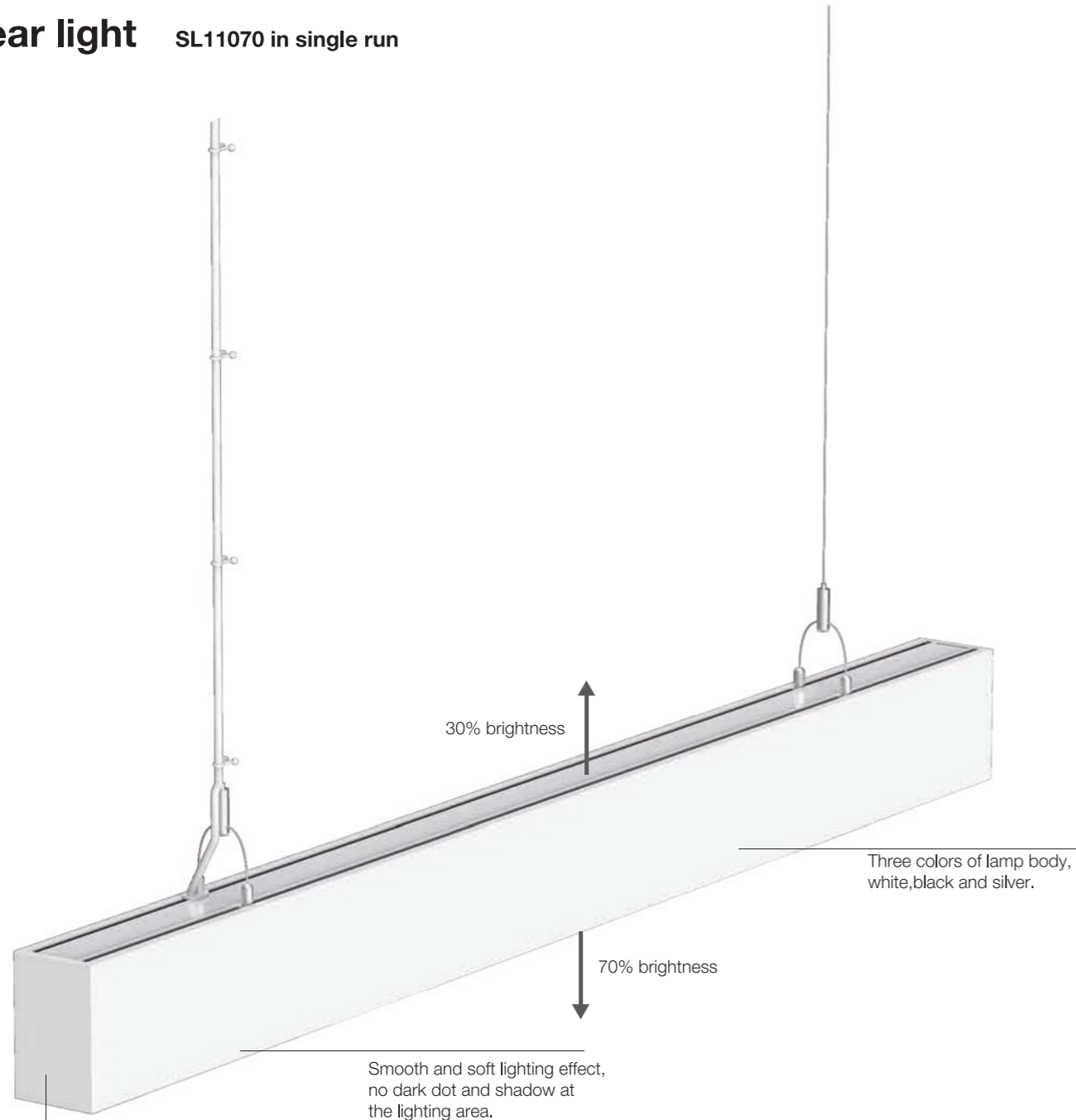

Size:(mm)

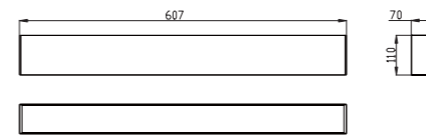

Model number	CCT	Light output (±10%)lm	Length mm	CRI
SC-SL11070-028-AW-01WW	2700-3200K	2658	607	≥80
SC-SL11070-028-AW-01NW	3900-4500K	2703	607	≥80
SC-SL11075-028-AW-01CW	5500-6500K	2469	607	≥80

Size:(mm)

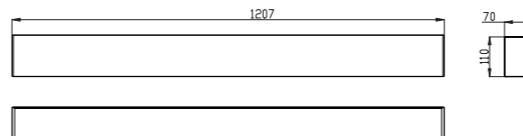

Model number	CCT	Light output (±10%)lm	Length mm	CRI
SC-SL11070-056-AW-01WW	2700-3200K	5246	1207	≥80
SC-SL11070-056-AW-01NW	3900-4500K	5340	1207	≥80
SC-SL11070-056-AW-01CW	5500-6500K	4953	1207	≥80

Size:(mm)

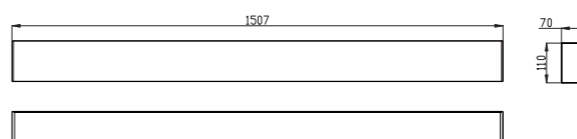

Model number	CCT	Light output (±10%)lm	Length mm	CRI
SC-SL11070-075-AW-01WW	2700-3200K	6704	1507	≥80
SC-SL11070-075-AW-01NW	3900-4500K	6520	1507	≥80
SC-SL11070-075-AW-01CW	5500-6500K	6214	1507	≥80

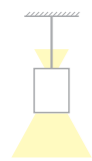

Suspending installation



# Linear light SL11070 in continuous run

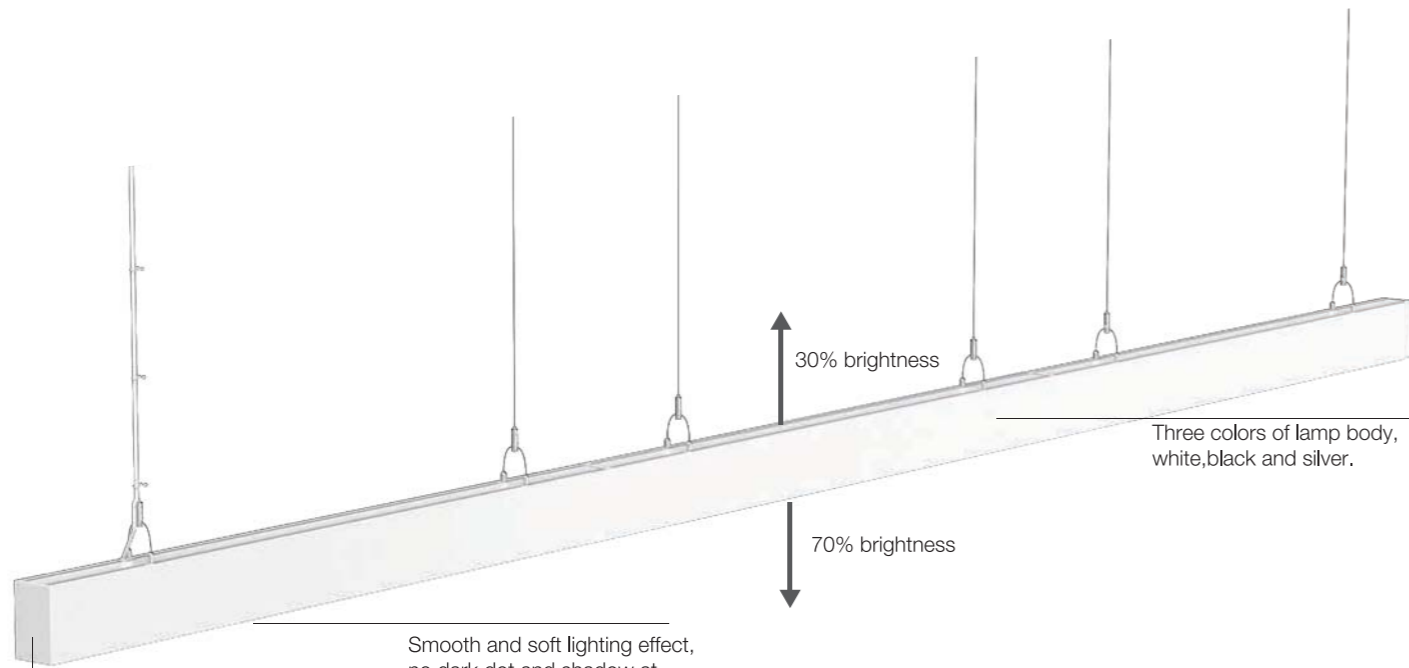

Simple and modern design, screwless at end cap.

Smooth and soft lighting effect, no dark dot and shadow at the lighting area.

Three colors of lamp body, white, black and silver.

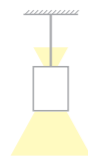
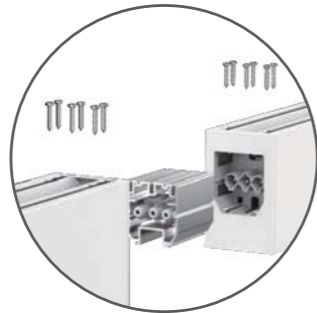

Suspendent installation

100-240VAC 28W 56W 75W 120° LED 2835 PF ≥0.9 Original design .IES eULms CE RoHS Warranty 5 years

Size:(mm)

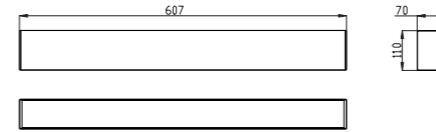

Size:(mm)

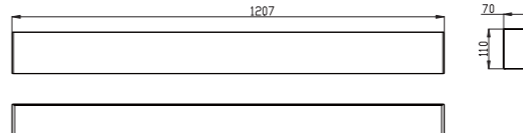

Size:(mm)

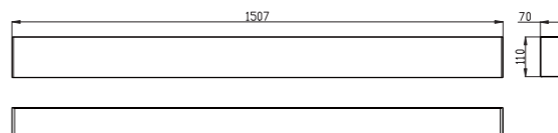

Model number	CCT	Light output (±10%)lm	Length mm	CRI
SC-SL11070-028-AW-02WW	2700-3200K	2658	607	≥80
SC-SL11070-028-AW-02NW	3900-4500K	2703	607	≥80
SC-SL11070-028-AW-02CW	5500-6500K	2469	607	≥80
SC-SL11070-028-AW-03WW	2700-3200K	2658	607	≥80
SC-SL11070-028-AW-03NW	3900-4500K	2703	607	≥80
SC-SL11070-028-AW-03CW	5500-6500K	2469	607	≥80
SC-SL11070-028-AW-04WW	2700-3200K	2658	607	≥80
SC-SL11070-028-AW-04NW	3900-4500K	2703	607	≥80
SC-SL11070-028-AW-04CW	5500-6500K	2469	607	≥80

Model number	CCT	Light output (±10%)lm	Length mm	CRI
SC-SL11070-056-AW-02WW	2700-3200K	5246	1207	≥80
SC-SL11070-056-AW-02NW	3900-4500K	5340	1207	≥80
SC-SL11070-056-AW-02CW	5500-6500K	4953	1207	≥80
SC-SL11070-056-AW-03WW	2700-3200K	5246	1207	≥80
SC-SL11070-056-AW-03NW	3900-4500K	5340	1207	≥80
SC-SL11070-056-AW-03CW	5500-6500K	4953	1207	≥80
SC-SL11070-056-AW-04WW	2700-3200K	5246	1207	≥80
SC-SL11070-056-AW-04NW	3900-4500K	5340	1207	≥80
SC-SL11070-056-AW-04CW	5500-6500K	4953	1207	≥80

Model number	CCT	Light output (±10%)lm	Length mm	CRI
SC-SL11070-075-AW-02WW	2700-3200K	6704	1507	≥80
SC-SL11070-075-AW-02NW	3900-4500K	6520	1507	≥80
SC-SL11070-075-AW-02CW	5500-6500K	6214	1507	≥80
SC-SL11070-075-AW-03WW	2700-3200K	6704	1507	≥80
SC-SL11070-075-AW-03NW	3900-4500K	6520	1507	≥80
SC-SL11070-075-AW-03CW	5500-6500K	6214	1507	≥80
SC-SL11070-075-AW-04WW	2700-3200K	6704	1507	≥80
SC-SL11070-075-AW-04NW	3900-4500K	6520	1507	≥80
SC-SL11070-075-AW-04CW	5500-6500K	6214	1507	≥80

# Linear light HL1919/HL1935

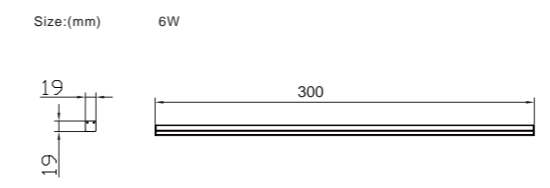
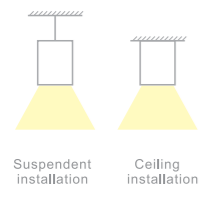
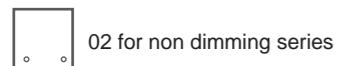
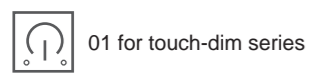
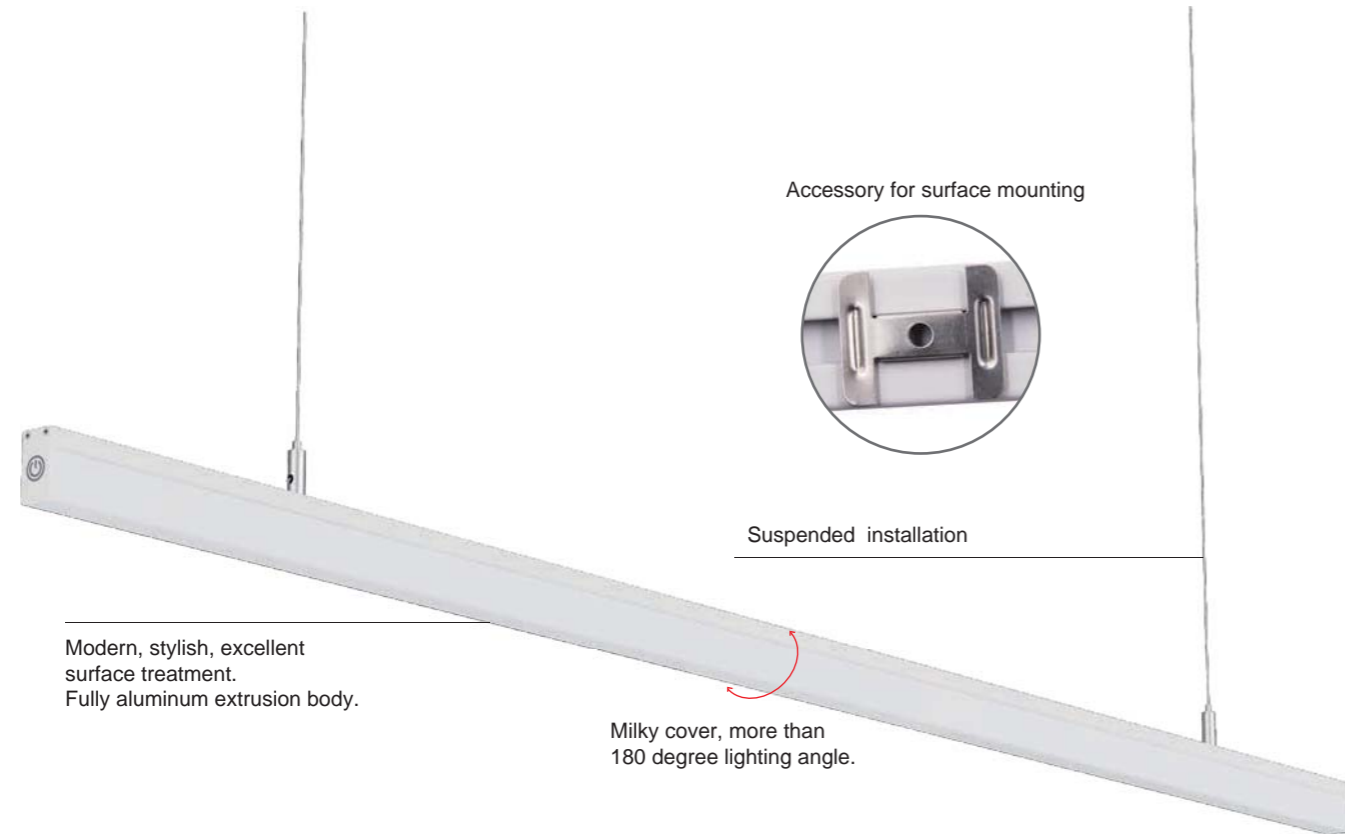

Model number	CCT	Light output (±10%)lm	Length mm	CRI
SC-HL1919-006-24V-01W	5500-6500K	501	300	≥80
SC-HL1919-006-24V-01NW	3900-4500K	490	300	≥80
SC-HL1919-006-24V-01WW	2700-3200K	452	300	≥80
SC-HL1919-006-24V-02W	5500-6500K	501	300	≥80
SC-HL1919-006-24V-02NW	3900-4500K	490	300	≥80
SC-HL1919-006-24V-02WW	2700-3200K	452	300	≥80

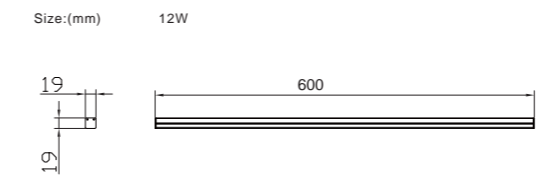

Model number	CCT	Light output (±10%)lm	Length mm	CRI
SC-HL1919-012-24V-01W	5500-6500K	1055	600	≥80
SC-HL1919-012-24V-01NW	3900-4500K	984	600	≥80
SC-HL1919-012-24V-01WW	2700-3200K	879	600	≥80
SC-HL1919-012-24V-02W	5500-6500K	1055	600	≥80
SC-HL1919-012-24V-02NW	3900-4500K	984	600	≥80
SC-HL1919-012-24V-02WW	2700-3200K	879	600	≥80

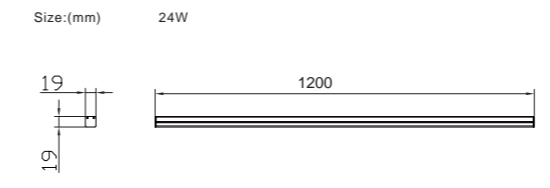

Model number	CCT	Light output (±10%)lm	Length mm	CRI
SC-HL1919-024-24V-01W	5500-6500K	2012	1200	≥80
SC-HL1919-024-24V-01NW	3900-4500K	2115	1200	≥80
SC-HL1919-024-24V-01WW	2700-3200K	1701	1200	≥80
SC-HL1919-024-24V-02W	5500-6500K	2012	1200	≥80
SC-HL1919-024-24V-02NW	3900-4500K	2115	1200	≥80
SC-HL1919-024-24V-02WW	2700-3200K	1701	1200	≥80

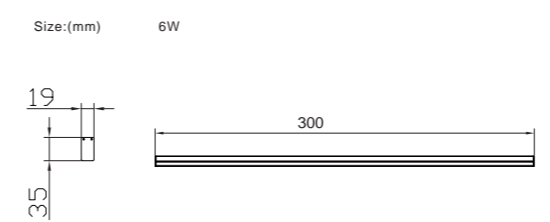

Model number	CCT	Light output (±10%)lm	Length mm	CRI
SC-HL1935-006-24V-01W	5500-6500K	522	300	≥80
SC-HL1935-006-24V-01NW	3900-4500K	506	300	≥80
SC-HL1935-006-24V-01WW	2700-3200K	466	300	≥80
SC-HL1935-006-24V-02W	5500-6500K	522	300	≥80
SC-HL1935-006-24V-02NW	3900-4500K	506	300	≥80
SC-HL1935-006-24V-02WW	2700-3200K	466	300	≥80

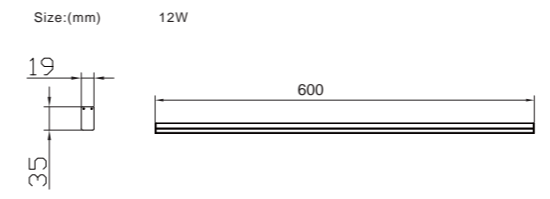

Model number	CCT	Light output (±10%)lm	Length mm	CRI
SC-HL1935-012-24V-01W	5500-6500K	1111	600	≥80
SC-HL1935-012-24V-01NW	3900-4500K	1025	600	≥80
SC-HL1935-012-24V-01WW	2700-3200K	919	600	≥80
SC-HL1935-012-24V-02W	5500-6500K	1111	600	≥80
SC-HL1935-012-24V-02NW	3900-4500K	1025	600	≥80
SC-HL1935-012-24V-02WW	2700-3200K	919	600	≥80

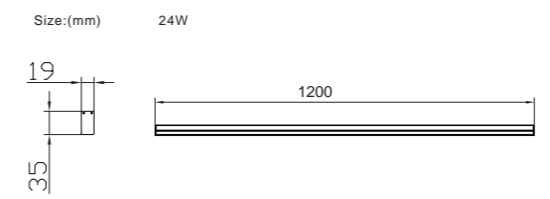

Model number	CCT	Light output (±10%)lm	Length mm	CRI
SC-HL1935-024-24V-01W	5500-6500K	2082	1200	≥80
SC-HL1935-024-24V-01NW	3900-4500K	2207	1200	≥80
SC-HL1935-024-24V-01WW	2700-3200K	1768	1200	≥80
SC-HL1935-024-24V-02W	5500-6500K	2082	1200	≥80
SC-HL1935-024-24V-02NW	3900-4500K	2207	1200	≥80
SC-HL1935-024-24V-02WW	2700-3200K	1768	1200	≥80

# Linear light HL4040

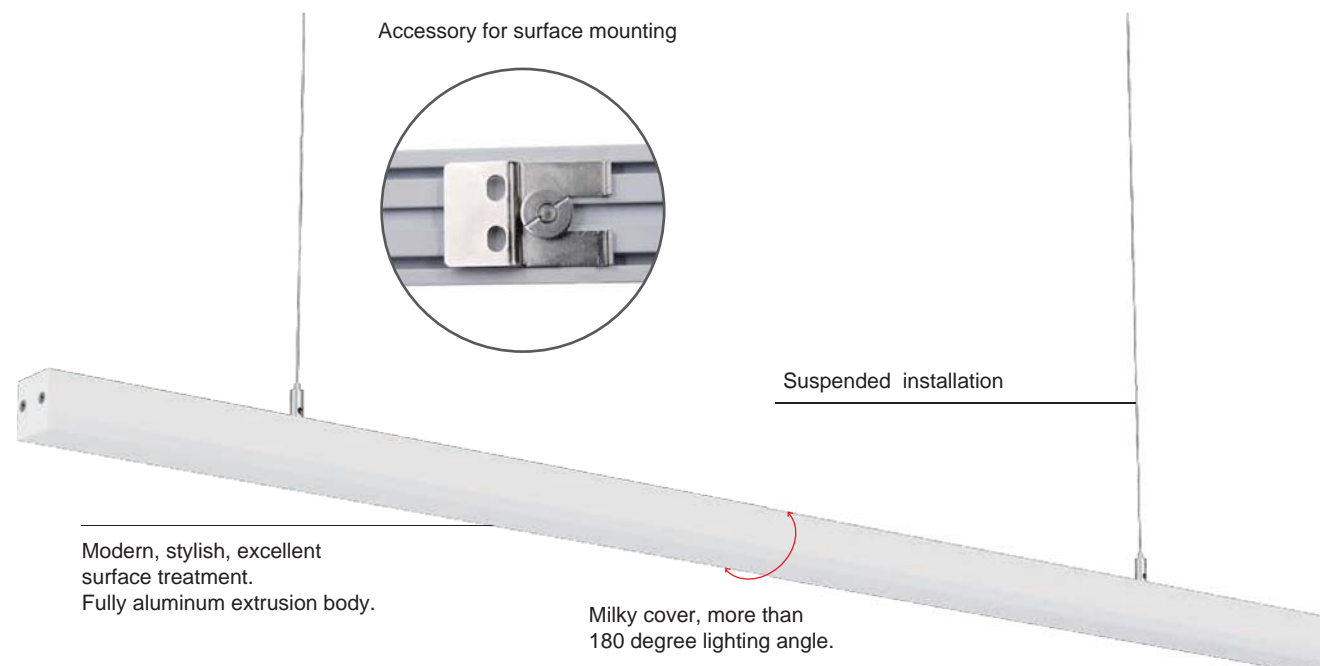

Size:(mm)

18W

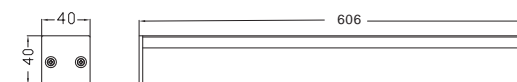

Model number	CCT	Light output (±10%)lm	Length mm	CRI
SC-HL4040-018-AW-01W	5500-6500K	1476	606	≥80
SC-HL4040-018-AW-01NW	3900-4500K	1759	606	≥80
SC-HL4040-018-AW-01WW	2700-3200K	1383	606	≥80

Size:(mm)

24W



Model number	CCT	Light output (±10%)lm	Length mm	CRI
SC-HL4040-024-AW-01W	5500-6500K	2241	1206	≥80
SC-HL4040-024-AW-01NW	3900-4500K	2319	1206	≥80
SC-HL4040-024-AW-01WW	2700-3200K	1952	1206	≥80

Size:(mm)

36W

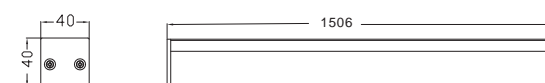

Model number	CCT	Light output (±10%)lm	Length mm	CRI
SC-HL4040-036-AW-01W	5500-6500K	3231	1506	≥80
SC-HL4040-036-AW-01NW	3900-4500K	3196	1506	≥80
SC-HL4040-036-AW-01WW	2700-3200K	2826	1506	≥80

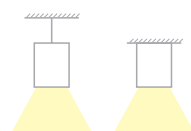

Suspended installation Ceiling installation



# Linear light LRB Round Batten

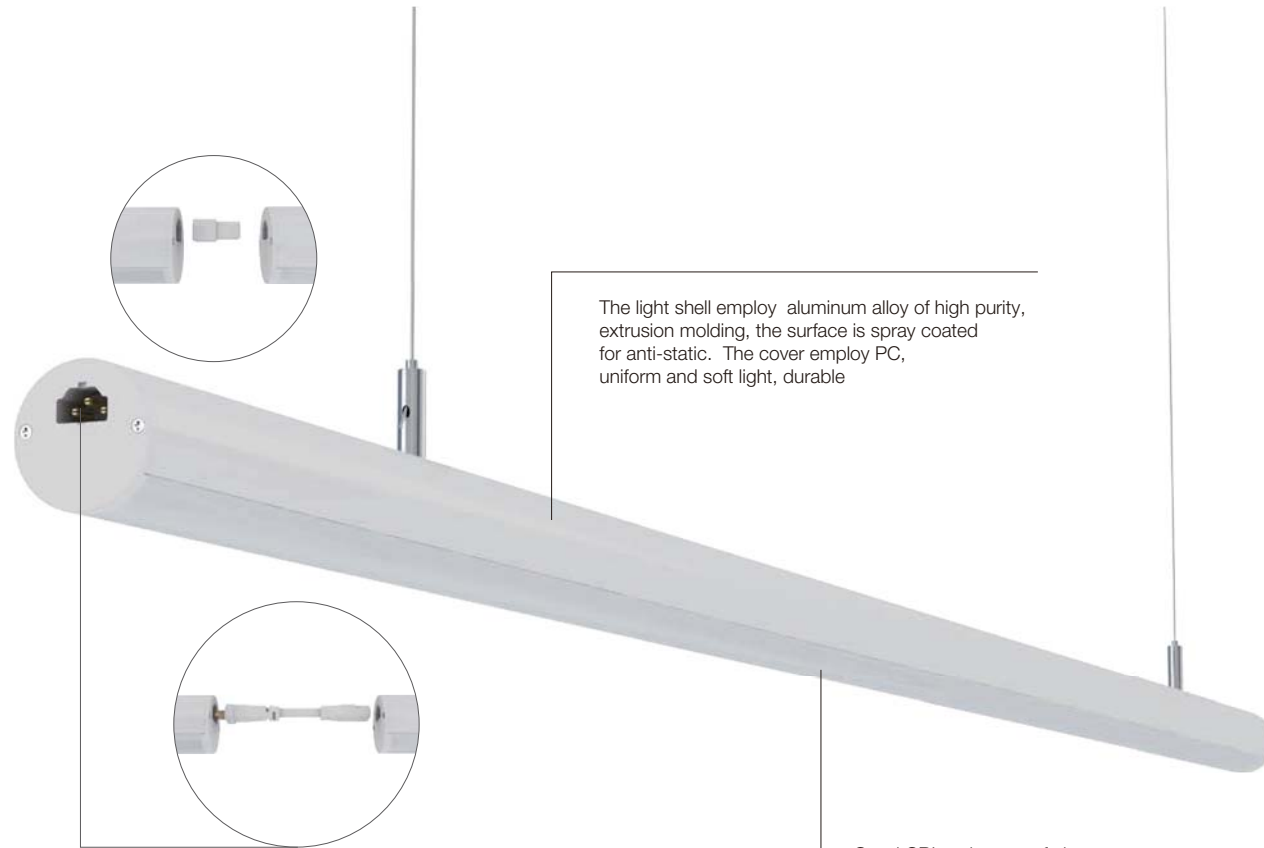

The light shell employ aluminum alloy of high purity, extrusion molding, the surface is spray coated for anti-static. The cover employ PC, uniform and soft light, durable

Good CRI, reduce eye fatigue; LED cold light source, no heat radiation,eco-friendly

Silver series can not be connected



Two installation methods:

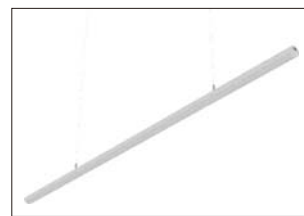

suspendent installation with steel wire



ceiling installation



Size:(mm/inch)

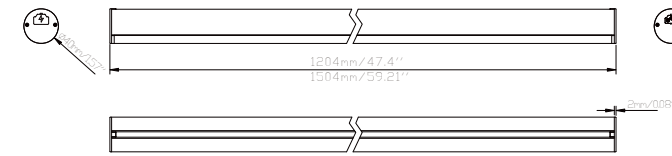

Model number	CCT	Light output (±10%)lm	LED Q'ty	CRI
White series				
LRB-024-AW-W-02F	5000K	3000	216	≥80
LRB-024-AW-NW-02F	4000K	3000	216	≥80
LRB-024-AW-WW-08F	3000K	2700	216	≥80
LRB-030-AW-W-02F	5000K	3700	264	≥80
LRB-030-AW-NW-02F	4000K	3700	264	≥80
LRB-030-AW-WW-08F	3000K	3300	264	≥80
Silver series				
LRB-024-AW-W-01F	5000K	3000	216	≥80
LRB-024-AW-NW-01F	4000K	3000	216	≥80
LRB-024-AW-WW-01F	3000K	2700	216	≥80
LRB-030-AW-W-01F	5000K	3700	264	≥80
LRB-030-AW-NW-01F	4000K	3700	264	≥80
LRB-030-AW-WW-01F	3000K	3300	264	≥80

# Linear light SL7250

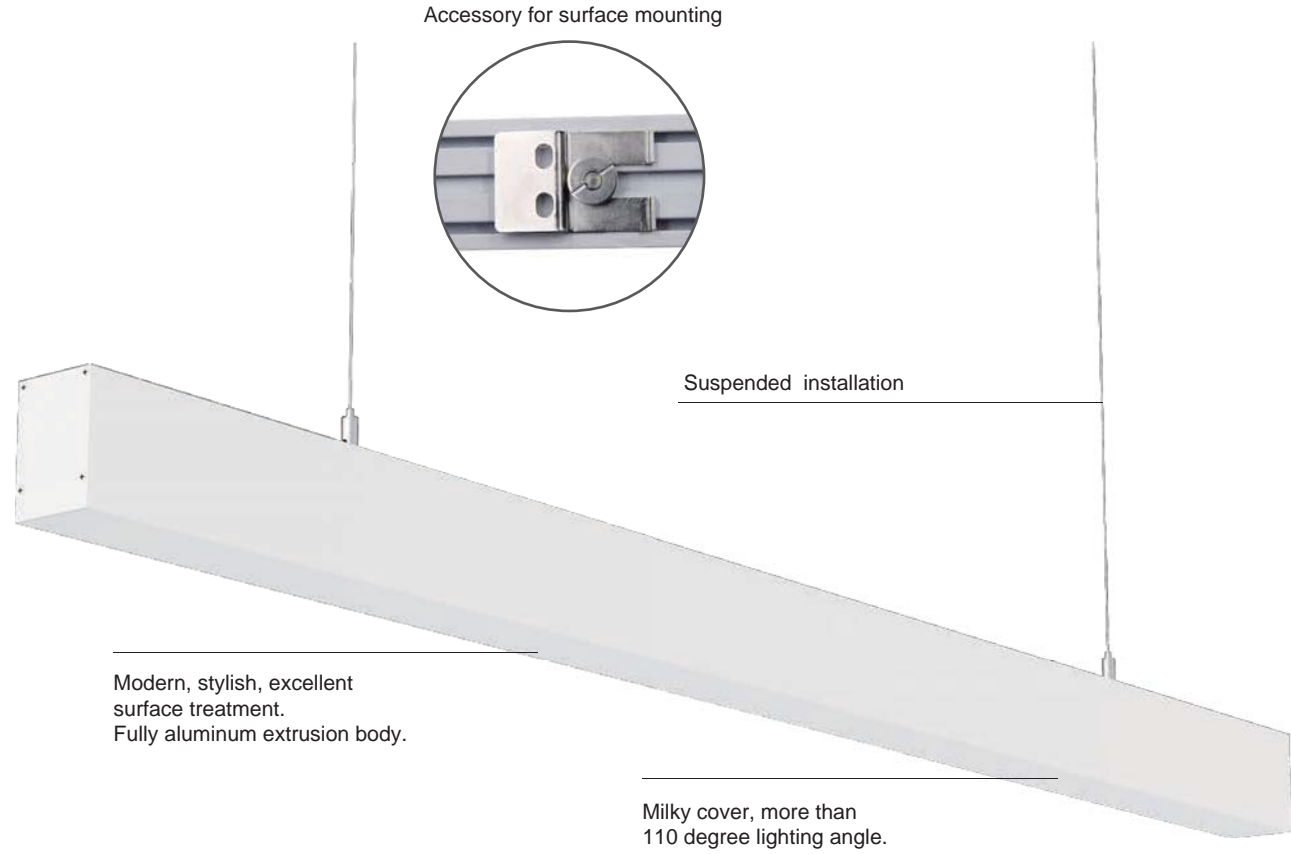

Size:(mm) 18W

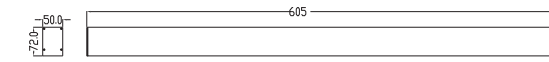

Model number	CCT	Light output (±10%)lm	Length mm	CRI
SC-SL7250-018-AW-01W	5500-6500K	1483	605	≥80
SC-SL7250-018-AW-01NW	3900-4500K	1447	605	≥80
SC-SL7250-018-AW-01WW	2700-3200K	1283	605	≥80

Size:(mm) 36W

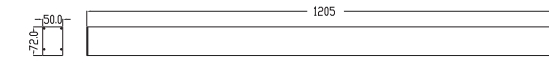

Model number	CCT	Light output (±10%)lm	Length mm	CRI
SC-SL7250-036-AW-01W	5500-6500K	2919	1205	≥80
SC-SL7250-036-AW-01NW	3900-4500K	2977	1205	≥80
SC-SL7250-036-AW-01WW	2700-3200K	2516	1205	≥80

Size:(mm) 45W



Model number	CCT	Light output (±10%)lm	Length mm	CRI
SC-SL7250-045-AW-01W	5500-6500K	3007	1505	≥80
SC-SL7250-045-AW-01NW	3900-4500K	3375	1505	≥80
SC-SL7250-045-AW-01WW	2700-3200K	2672	1505	≥80

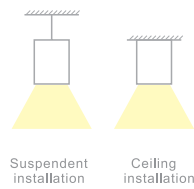

# Linear light RL4932

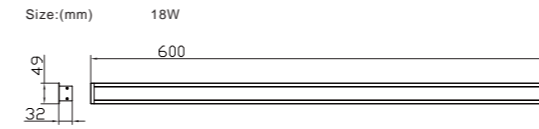
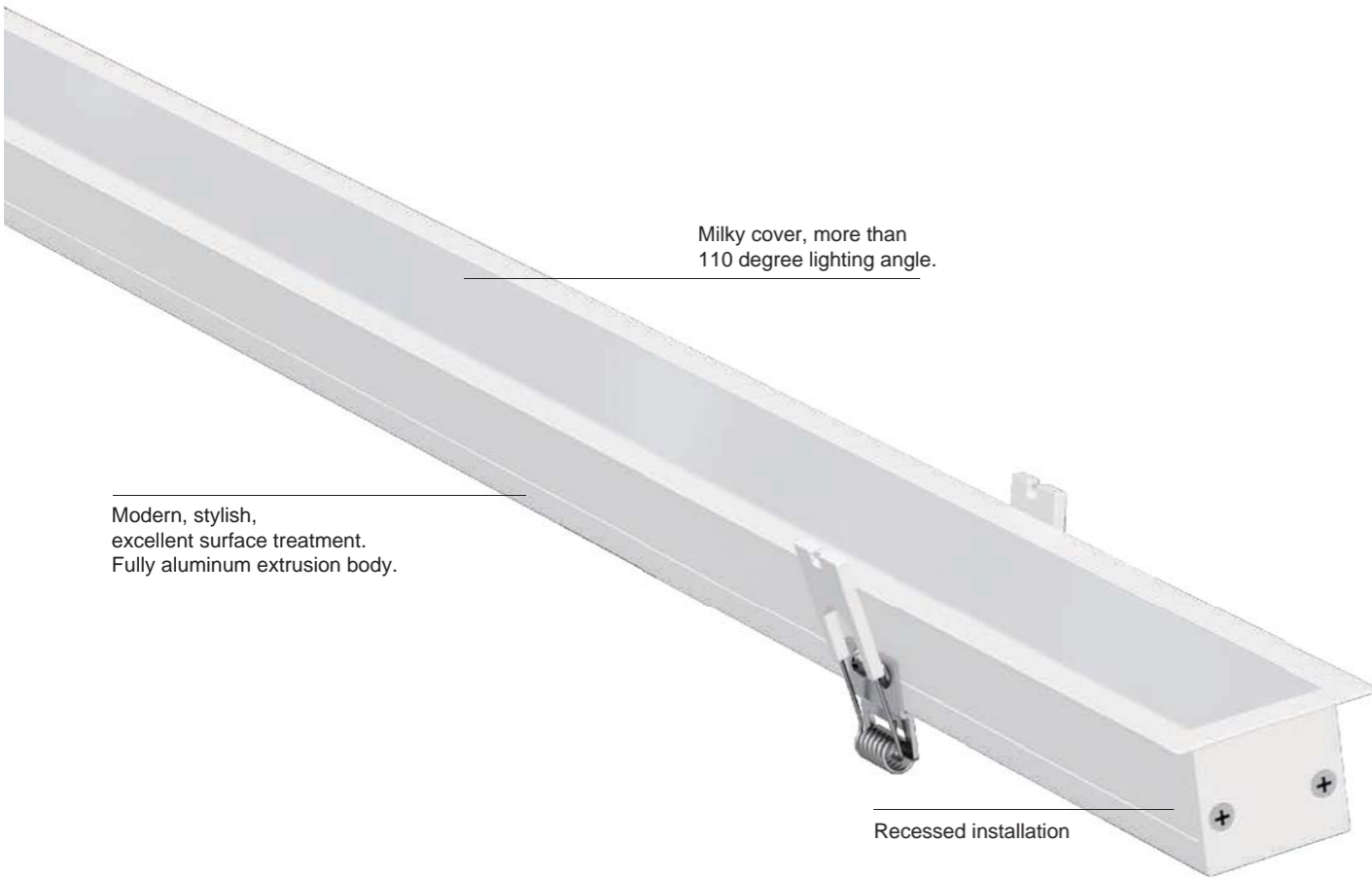

Model number	CCT	Light output (±10%/lm)	Length mm	CRI
SC-RL4932-018-AW-01W	5500-6500K	1375	600	≥80
SC-RL4932-018-AW-01NW	3900-4500K	1410	600	≥80
SC-RL4932-018-AW-01WW	2700-3200K	1195	600	≥80

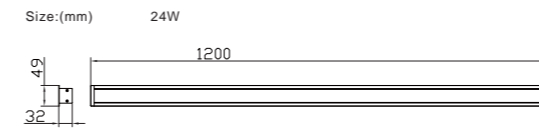

Model number	CCT	Light output (±10%/lm)	Length mm	CRI
SC-RL4932-024-AW-01W	5500-6500K	1745	1200	≥80
SC-RL4932-024-AW-01NW	3900-4500K	1730	1200	≥80
SC-RL4932-024-AW-01WW	2700-3200K	1570	1200	≥80

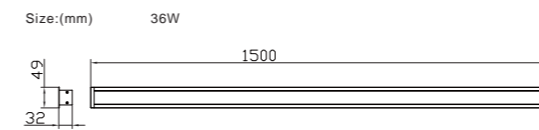

Model number	CCT	Light output (±10%/lm)	Length mm	CRI
SC-RL4932-036-AW-01W	5500-6500K	2990	1500	≥80
SC-RL4932-036-AW-01NW	3900-4500K	2790	1500	≥80
SC-RL4932-036-AW-01WW	2700-3200K	2490	1500	≥80



Embedded Installation



# Linear light RL7035

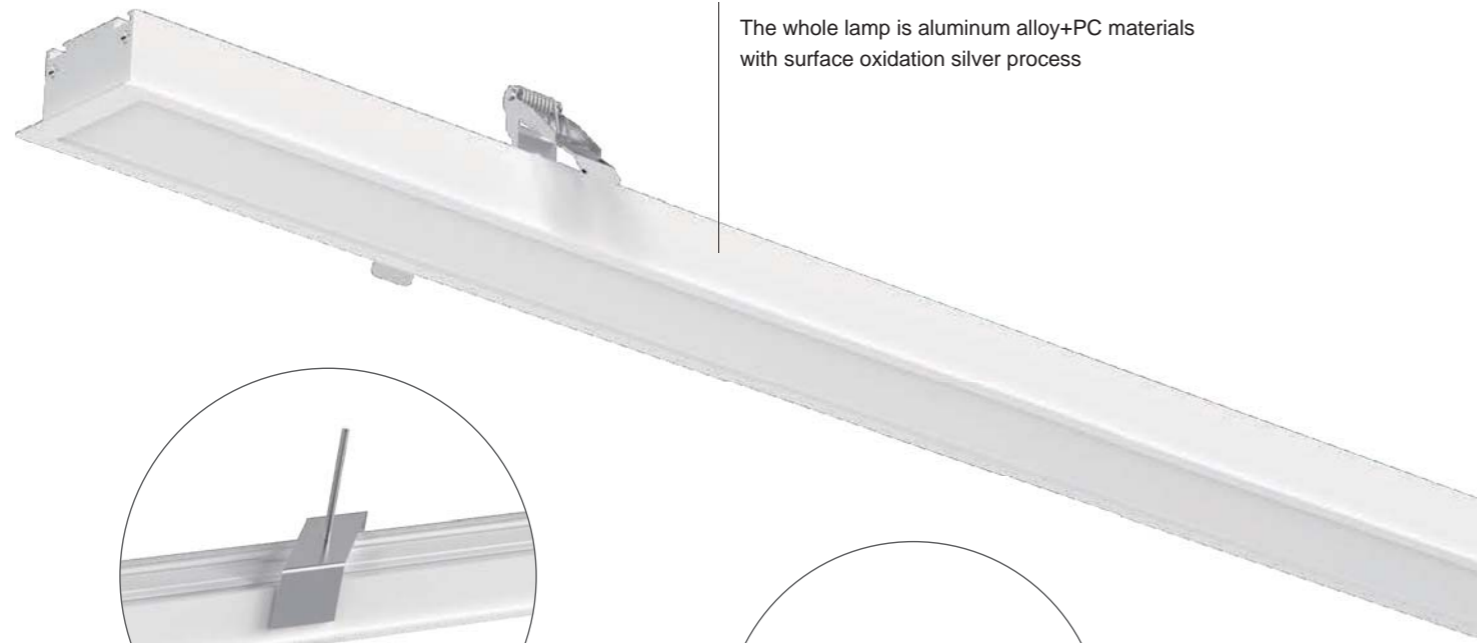

The whole lamp is aluminum alloy+PC materials with surface oxidation silver process



U-shaped support installation



spring buckle type installation

Size:(mm)

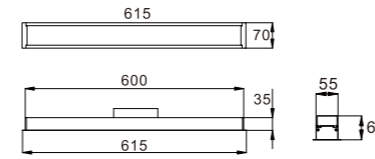

Size:(mm)

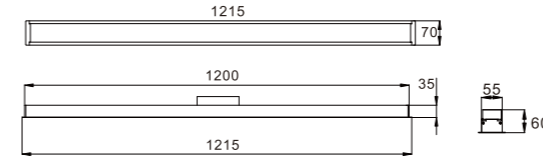

Size:(mm)

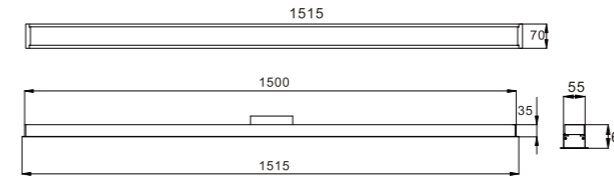

Model number	CCT	Light output (±10%)lm	Length mm	CRI
SC-RL7035-020-AW-CW	6000-6500K	1500	615	≥80
SC-RL7035-020-AW-NW	3800-4200K	1500	615	≥80
SC-RL7035-020-AW-WW	2800-3200K	1300	615	≥80
SC-RL7035-020-AW-01CW	6000-6500K	1500	615	≥80
SC-RL7035-020-AW-01NW	3800-4200K	1500	615	≥80
SC-RL7035-020-AW-01WW	2800-3200K	1300	615	≥80

Model number	CCT	Light output (±10%)lm	Length mm	CRI
SC-RL7035-040-AW-CW	6000-6500K	3000	1215	≥80
SC-RL7035-040-AW-NW	3800-4200K	3000	1215	≥80
SC-RL7035-040-AW-WW	2800-3200K	2600	1215	≥80
SC-RL7035-040-AW-01CW	6000-6500K	3000	1215	≥80
SC-RL7035-040-AW-01NW	3800-4200K	3000	1215	≥80
SC-RL7035-040-AW-01WW	2800-3200K	2600	1215	≥80

Model number	CCT	Light output (±10%)lm	Length mm	CRI
SC-RL7035-050-AW-CW	6000-6500K	3750	1515	≥80
SC-RL7035-050-AW-NW	3800-4200K	3750	1515	≥80
SC-RL7035-050-AW-WW	2800-3200K	3250	1515	≥80
SC-RL7035-050-AW-01CW	6000-6500K	3750	1515	≥80
SC-RL7035-050-AW-01NW	3800-4200K	3750	1515	≥80
SC-RL7035-050-AW-01WW	2800-3200K	3250	1515	≥80

\* Multiple jointing can realized Via "+" "L" "T" shape connecting accessories

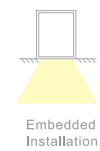

Embedded Installation





# Linear light RL13054

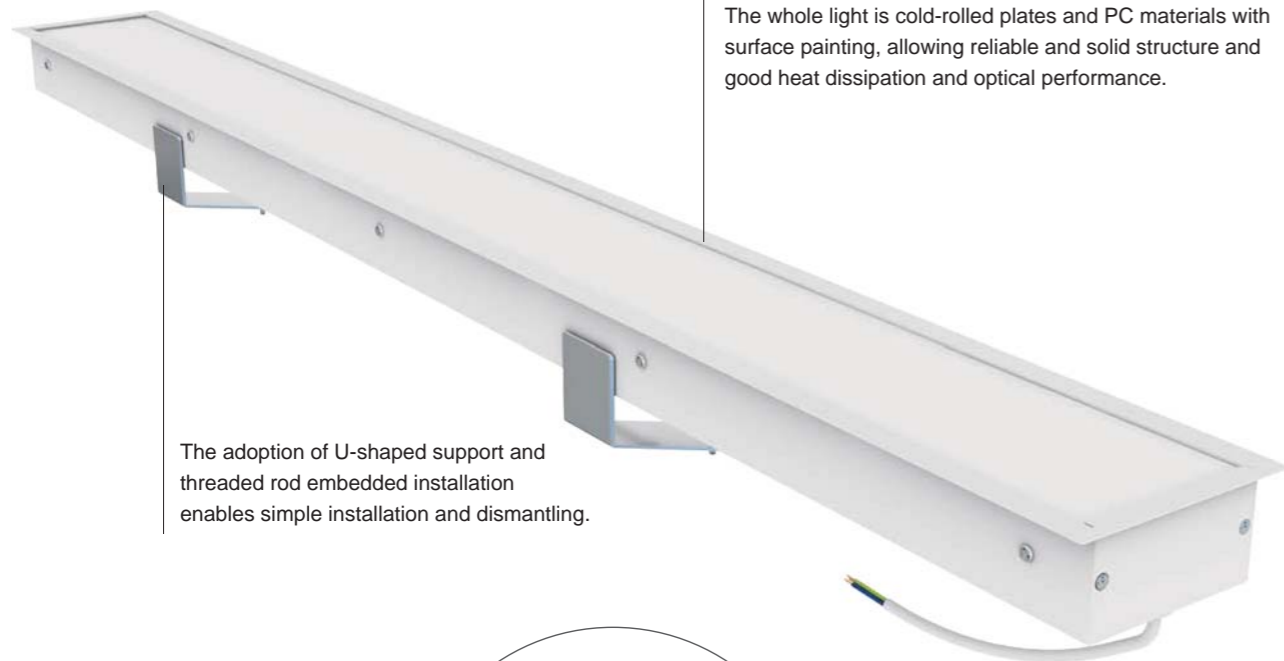

The whole light is cold-rolled plates and PC materials with surface painting, allowing reliable and solid structure and good heat dissipation and optical performance.

The adoption of U-shaped support and threaded rod embedded installation enables simple installation and dismantling.



Size:(mm)

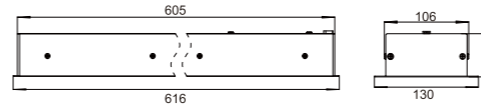

Model number	CCT	Light output (±10%)lm	Length mm	CRI
SC-RL13054-020-AW-CW	6000-6500K	2000	616	≥80
SC-RL13054-020-AW-NW	3800-4200K	2000	616	≥80
SC-RL13054-020-AW-WW	2800-3200K	1800	616	≥80
SC-RL13054-020-AW-A01-CW	6000-6500K	2000	616	≥80
SC-RL13054-020-AW-A01-NW	3800-4200K	2000	616	≥80
SC-RL13054-020-AW-A01-WW	2800-3200K	1800	616	≥80

Size:(mm)

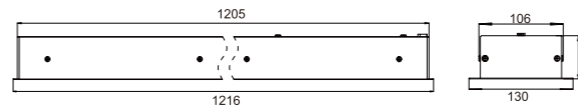

Model number	CCT	Light output (±10%)lm	Length mm	CRI
SC-RL13054-040-AW-CW	6000-6500K	4000	1216	≥80
SC-RL13054-040-AW-NW	3800-4200K	4000	1216	≥80
SC-RL13054-040-AW-WW	2800-3200K	3600	1216	≥80
SC-RL13054-040-AW-A01-CW	6000-6500K	4000	1216	≥80
SC-RL13054-040-AW-A01-NW	3800-4200K	4000	1216	≥80
SC-RL13054-040-AW-A01-WW	2800-3200K	3600	1216	≥80

Size:(mm)

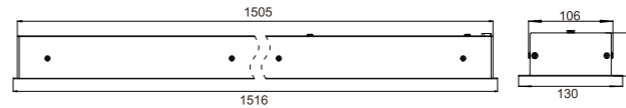

Model number	CCT	Light output (±10%)lm	Length mm	CRI
SC-RL13054-050-AW-CW	6000-6500K	5000	1516	≥80
SC-RL13054-050-AW-NW	3800-4200K	5000	1516	≥80
SC-13054-050-AW-WW	2800-3200K	4500	1516	≥80
SC-RL13054-050-AW-A01-CW	6000-6500K	5000	1516	≥80
SC-RL13054-050-AW-A01-NW	3800-4200K	5000	1516	≥80
SC-13054-050-AW-A01-WW	2800-3200K	4500	1516	≥80

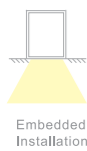

Embedded Installation

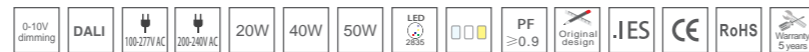

# Linear light

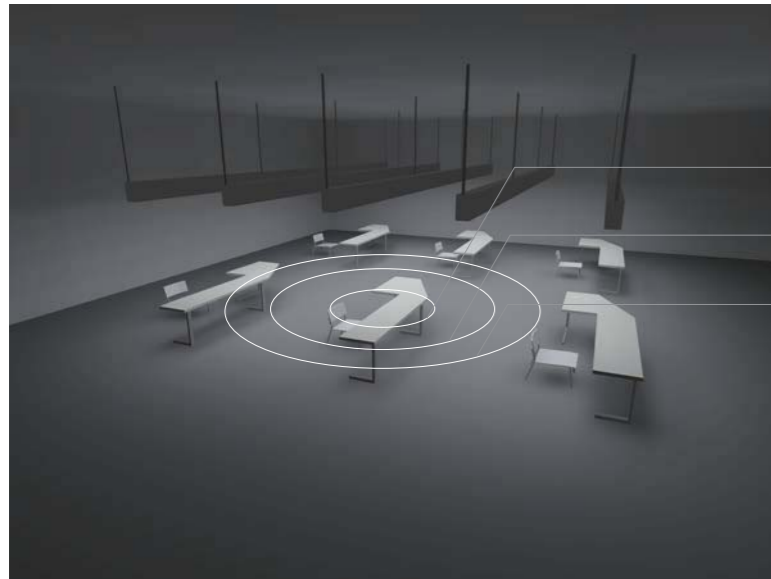

120Lux  
90Lux  
60Lux

Values in Lux, Scale 1 : 200

Position of surface in room:  
Marked point:  
(0.000 m, 32.469 m, 1.500 m)

Grid: 128 x 128 Points

$E_{av}$ [lx]	$E_{min}$ [lx]	$E_{max}$ [lx]	u0	$E_{min}/E_{max}$
51	1.06	143	0.021	0.007

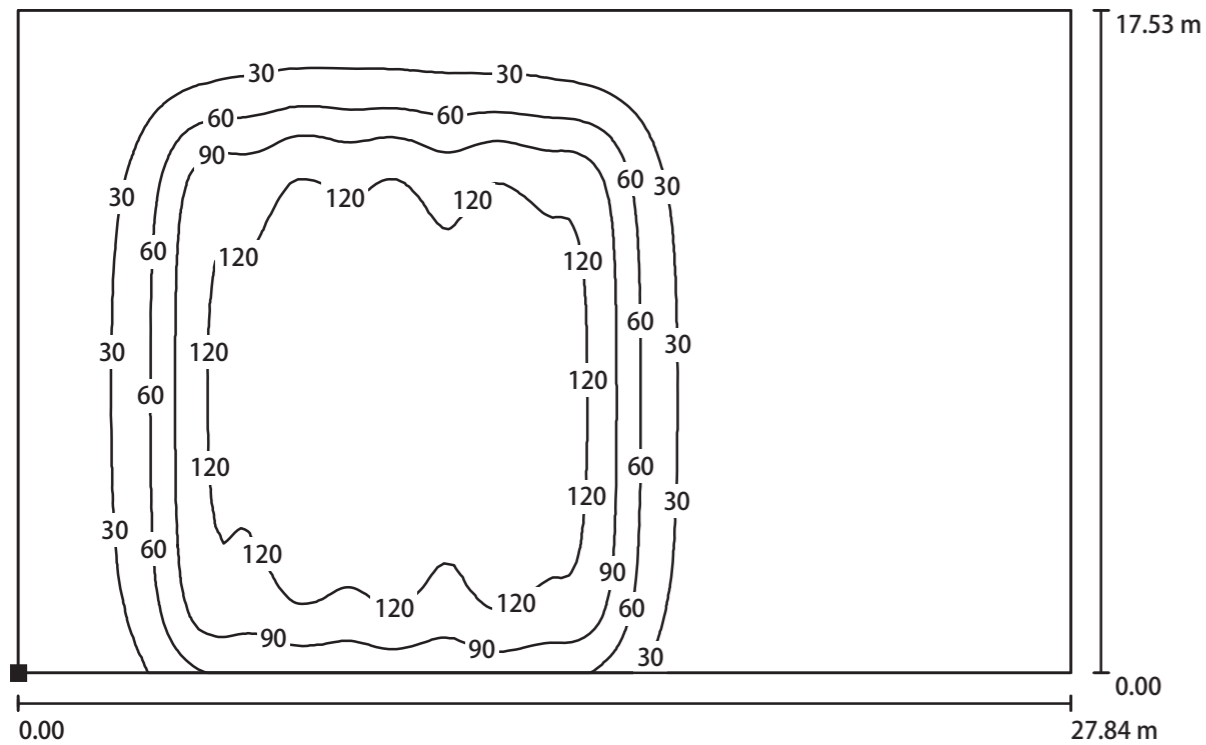

Scale: 1 : 25

Horizontal illuminance (Grid)  
Average: 305 lx, Min: 243 lx, Max: 376 lx, Min/average: 0.797, Min/max: 0.646, Points: 3 x 7 (Relevant: all)

## Calculation surface 1 / Isolines/Horizontal illuminance

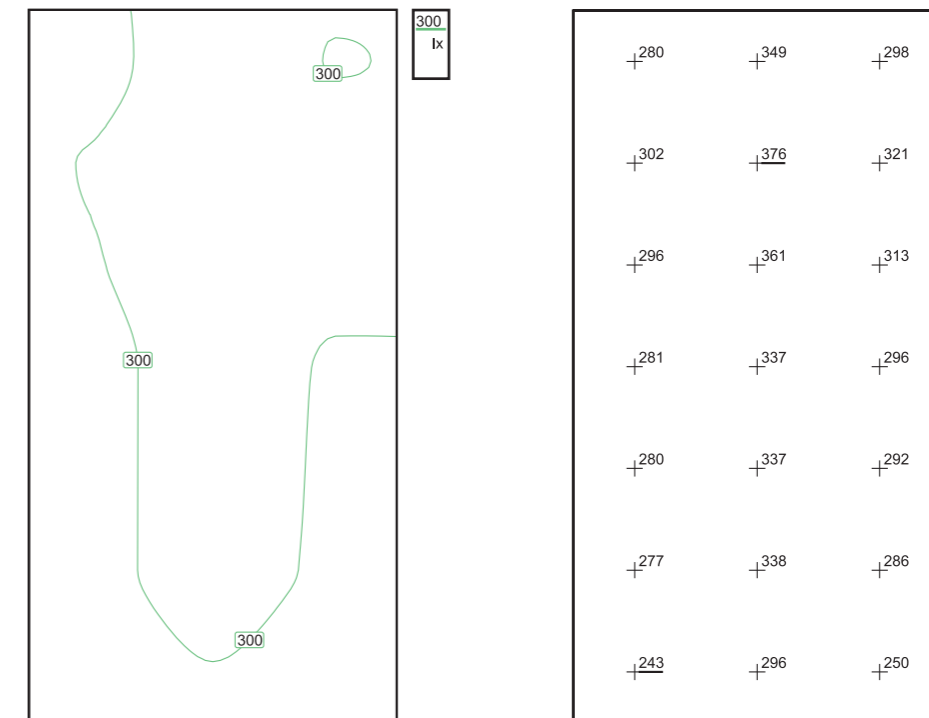



# STRIP LIGHT



- LED Shop Light ..... 179-184
- LED Wraparound ..... 185-186
- LED Strip Light ..... 187-190

# LED Shop Light (LSL)

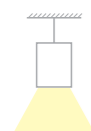

Suspending installation



Size:(mm) 40W

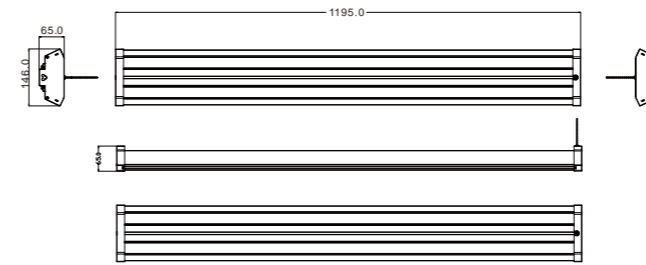

Model number	CCT	Light output (±10%)lm	Length mm	CRI
<b>Frosted</b>				
LSL-040-AW-WW-01F	2800-3100K	4100	1200	≥80
LSL-040-AW-NW-01F	3800-4250K	4390	1200	≥80
LSL-040-AW-W-01F	4750-5300K	4580	1200	≥80
<b>Clear</b>				
LSL-040-AW-WW-01C	2800-3100K	4428	1200	≥80
LSL-040-AW-NW-01C	3800-4250K	4741	1200	≥80
LSL-040-AW-W-01C	4750-5300K	4946	1200	≥80

# LED Shop Light (SH01)

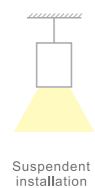

Size:(mm) 36W

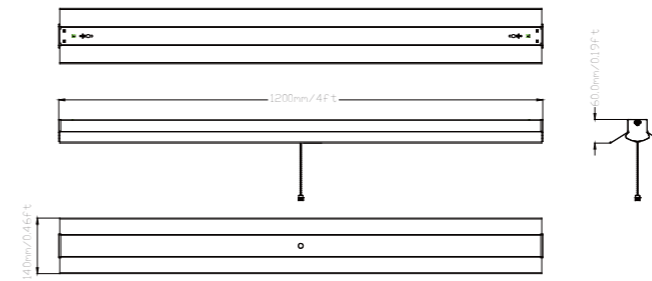

Model number	CCT	Light output (±10%)lm	Length mm	CRI
Frosted				
SH01-024-AW-WW-01F	2800-3100K	2100	1200	≥80
SH01-024-AW-NW-01F	3800-4250K	2400	1200	≥80
SH01-024-AW-W-01F	4750-5300K	2360	1200	≥80

# LED Shop Light (SH02)



Size:(mm) 36W

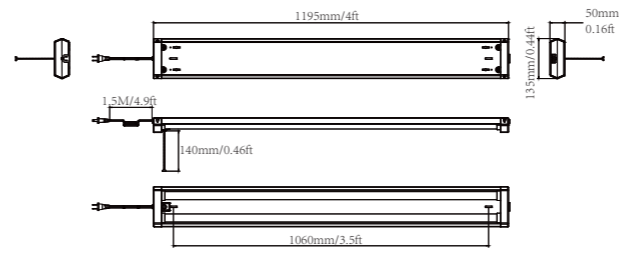

Model number	CCT	Light output (±10%)lm	Length mm	CRI
Frosted				
SH02-036-AW-WW-01F	2800-3100K	2840	1200	≥80
SH02-036-AW-NW-01F	3800-4250K	3050	1200	≥80
SH02-036-AW-W-01F	4750-5300K	3240	1200	≥80

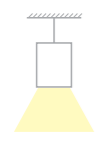

Suspending installation



# LED Wraparound light

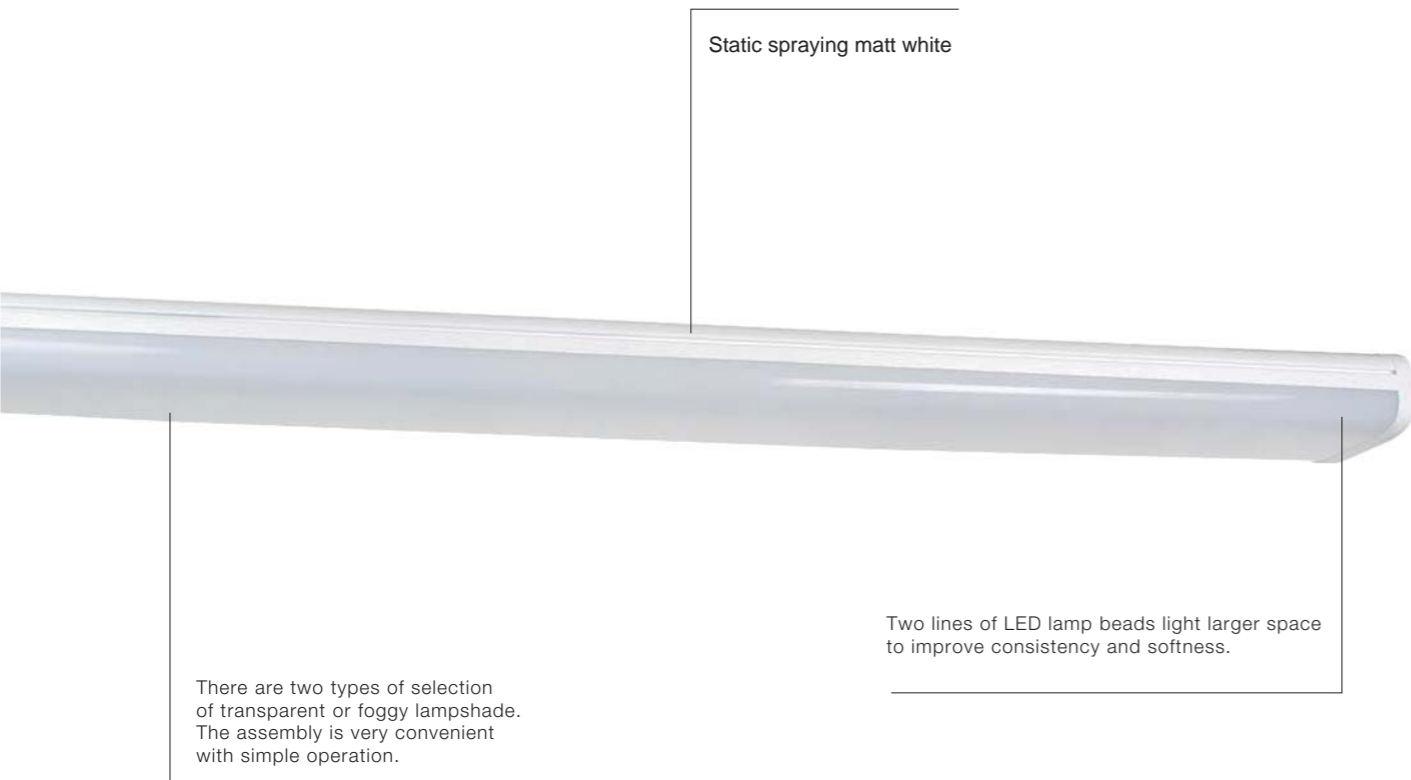

Static spraying matt white

Two lines of LED lamp beads light larger space to improve consistency and softness.

There are two types of selection of transparent or foggy lampshade. The assembly is very convenient with simple operation.



Various installation: Suspendent ceiling and recessed.

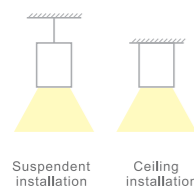

Size:(mm) 40W

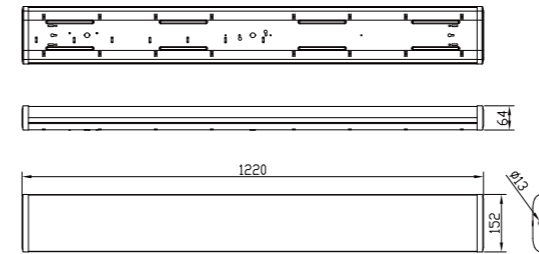

Size:(mm) 40W

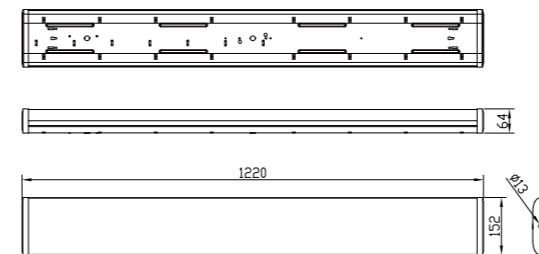

Size:(mm) 40W

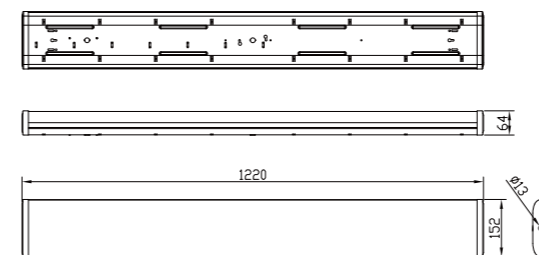

## 100-277V non-dimming series

Model number	CCT	Light output (±10%)lm	Length mm	CRI
Frosted				
WD-040-AW-WW-01F	2800-3100K	4000	1200	≥80
WD-040-AW-NW-01F	3800-4250K	4300	1200	≥80
WD-040-AW-W-01F	5700-6500K	4500	1200	≥80
Clear				
WD-040-AW-WW-01C	2800-3100K	5000	1200	≥80
WD-040-AW-NW-01C	3800-4250K	5200	1200	≥80
WD-040-AW-W-01C	5700-6500K	5300	1200	≥80

## 0-10V Dimmers Series

Model number	CCT	Light output (±10%)lm	Length mm	CRI
Frosted				
WDD-040-AW-WW-01F	2800-3100K	4069	1200	≥80
WDD-040-AW-NW-01F	3800-4250K	4478	1200	≥80
WDD-040-AW-W-01F	4750-5300K	4227	1200	≥80
WDD-040-AW-W-02F	5700-6500K	4253	1200	≥80
Clear				
WDD-040-AW-WW-01C	2800-3100K	4650	1200	≥80
WDD-040-AW-NW-01C	3800-4250K	4920	1200	≥80
WDD-040-AW-W-01C	4750-5300K	4760	1200	≥80
WDD-040-AW-W-02C	5700-6500K	4785	1200	≥80

## Microwave Sensing Series

Model number	CCT	Light output (±10%)lm	Length mm	CRI
Frosted				
WDM-040-AW-WW-01F	2800-3100K	4069	1200	≥80
WDM-040-AW-NW-01F	3800-4250K	4478	1200	≥80
WDM-040-AW-W-01F	4750-5300K	4227	1200	≥80
WDM-040-AW-W-02F	5700-6500K	4253	1200	≥80
Clear				
WDM-040-AW-WW-01C	2800-3100K	4650	1200	≥80
WDM-040-AW-NW-01C	3800-4250K	4920	1200	≥80
WDM-040-AW-W-01C	4750-5300K	4760	1200	≥80
WDM-040-AW-W-02C	5700-6500K	4785	1200	≥80



# LED Strip light



The lampshade adopts PC materials and is not easy to break, resistant to ultraviolet light

LED cold light source without thermal radiation, green and environment sound, Good LED color indexing can relieve eye fatigue.

Size:(mm) 24W

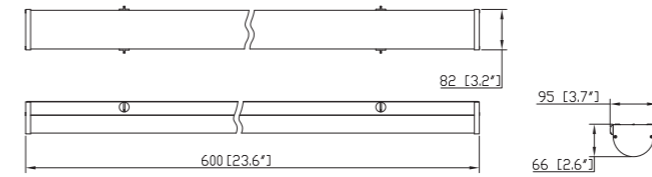

Model number CCT Light output Length CRI

**100-277V Non-dimming series**

Model number	CCT	Light output (±10%)lm	Length mm	CRI
ST-024-AW-WW-01C	2800-3100K	3040	600	≥80
ST-024-AW-NW-01C	3800-4250K	3100	600	≥80
ST-024-AW-W-01C	4750-5300K	3155	600	≥80
ST-024-AW-W-02C	5700-6500K	3155	600	≥80
ST-024-AW-WW-01T	2800-3100K	2750	600	≥80
ST-024-AW-NW-01T	3800-4250K	2800	600	≥80
ST-024-AW-W-01T	4750-5300K	2850	600	≥80
ST-024-AW-W-02T	5700-6500K	2850	600	≥80

**0-10V Dimmers Series**

Model number	CCT	Light output (±10%)lm	Length mm	CRI
STD-024-AW-WW-01C	2800-3100K	2782	600	≥80
STD-024-AW-NW-01C	3800-4250K	2935	600	≥80
STD-024-AW-W-01C	4750-5300K	2985	600	≥80
STD-024-AW-W-02C	5700-6500K	2960	600	≥80
STD-024-AW-WW-01T	2800-3100K	2583	600	≥80
STD-024-AW-NW-01T	3800-4250K	2765	600	≥80
STD-024-AW-W-01T	4750-5300K	2757	600	≥80
STD-024-AW-W-02T	5700-6500K	2830	600	≥80

**Microwave Sensing Series**

Model number	CCT	Light output (±10%)lm	Length mm	CRI
STM-024-AW-WW-01C	2800-3100K	2782	600	≥80
STM-024-AW-NW-01C	3800-4250K	2935	600	≥80
STM-024-AW-W-01C	4750-5300K	2985	600	≥80
STM-024-AW-W-02C	5700-6500K	2960	600	≥80
STM-024-AW-WW-01T	2800-3100K	2583	600	≥80
STM-024-AW-NW-01T	3800-4250K	2765	600	≥80
STM-024-AW-W-01T	4750-5300K	2757	600	≥80
STM-024-AW-W-02T	5700-6500K	2830	600	≥80

Size:(mm) 24W / 36W

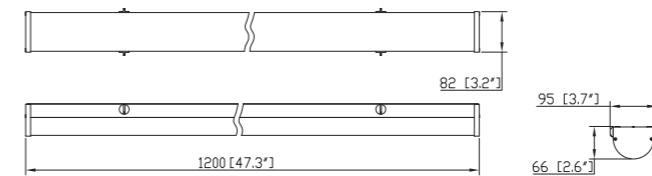

Model number CCT Light output Length CRI

**100-277V Non-dimming series**

Model number	CCT	Light output (±10%)lm	Length mm	CRI
ST-024-AW-WW-03C	2800-3100K	3040	1200	≥80
ST-024-AW-NW-03C	3800-4250K	3100	1200	≥80
ST-024-AW-W-03C	4750-5300K	3155	1200	≥80
ST-024-AW-WW-03C	5700-6500K	3155	1200	≥80
ST-024-AW-WW-03T	2800-3100K	2750	1200	≥80
ST-024-AW-NW-03T	3800-4250K	2800	1200	≥80
ST-024-AW-W-03T	4750-5300K	2850	1200	≥80
ST-024-AW-WW-03T	5700-6500K	2850	1200	≥80

ST-036-AW-WW-01C	2800-3100K	4560	1200	≥80
ST-036-AW-NW-01C	3800-4250K	4650	1200	≥80
ST-036-AW-W-01C	4750-5300K	4730	1200	≥80
ST-036-AW-W-02C	5700-6500K	4730	1200	≥80
ST-036-AW-WW-01T	2800-3100K	4120	1200	≥80
ST-036-AW-NW-01T	3800-4250K	4200	1200	≥80
ST-036-AW-W-01T	4750-5300K	4275	1200	≥80
ST-036-AW-W-02T	5700-6500K	4275	1200	≥80

**0-10V Dimmers Series**

Model number	CCT	Light output (±10%)lm	Length mm	CRI
STD-024-AW-WW-03C	2800-3100K	2820	1200	≥80
STD-024-AW-NW-03C	3800-4250K	3010	1200	≥80
STD-024-AW-W-03C	4750-5300K	3035	1200	≥80
STD-024-AW-W-03C	5700-6500K	2980	1200	≥80
STD-024-AW-WW-03T	2800-3100K	2629	1200	≥80
STD-024-AW-NW-03T	3800-4250K	2836	1200	≥80
STD-024-AW-W-03T	4750-5300K	2798	1200	≥80
STD-024-AW-W-03T	5700-6500K	2810	1200	≥80

STD-036-AW-WW-01C	2800-3100K	4430	1200	≥80
STD-036-AW-NW-01C	3800-4250K	4620	1200	≥80
STD-036-AW-W-01C	4750-5300K	4730	1200	≥80
STD-036-AW-W-02C	5700-6500K	4680	1200	≥80
STD-036-AW-WW-01T	2800-3100K	4124	1200	≥80
STD-036-AW-NW-01T	3800-4250K	4459	1200	≥80
STD-036-AW-W-01T	4750-5300K	4450	1200	≥80
STD-036-AW-W-02T	5700-6500K	4380	1200	≥80

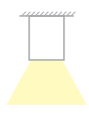

Ceiling installation



Size:(mm) 24W / 36W

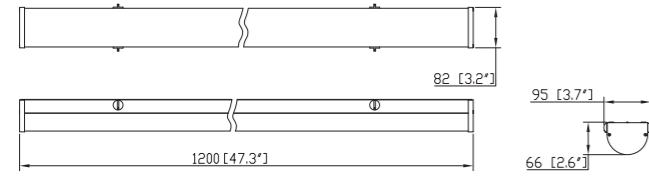

Model number	CCT	Light output (±10%)lm	Length mm	CRI
--------------	-----	--------------------------	--------------	-----

**Microwave Sensing Series**

STM-024-AW-WW-03C	2800-3100K	2820	1200	≥80
STM-024-AW-NW-03C	3800-4250K	3010	1200	≥80
STM-024-AW-WW-03C	4750-5300K	3035	1200	≥80
STM-024-AW-WW-03C	5700-6500K	2980	1200	≥80
STM-024-AW-WW-03T	2800-3100K	2629	1200	≥80
STM-024-AW-NW-03T	3800-4250K	2836	1200	≥80
STM-024-AW-WW-03T	4750-5300K	2798	1200	≥80
STM-024-AW-WW-03T	5700-6500K	2810	1200	≥80
STM-036-AW-WW-01C	2800-3100K	4430	1200	≥80
STM-036-AW-NW-01C	3800-4250K	4620	1200	≥80
STM-036-AW-WW-01C	4750-5300K	4730	1200	≥80
STM-036-AW-WW-02C	5700-6500K	4680	1200	≥80
STM-036-AW-WW-01T	2800-3100K	4124	1200	≥80
STM-036-AW-NW-01T	3800-4250K	4459	1200	≥80
STM-036-AW-WW-01T	4750-5300K	4450	1200	≥80
STM-036-AW-WW-02T	5700-6500K	4380	1200	≥80

Size:(mm) 68W

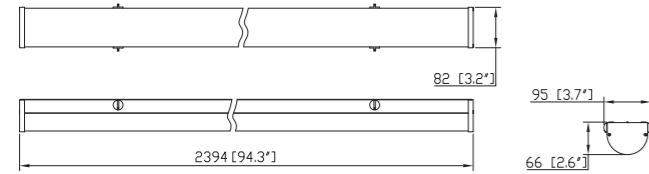

Model number	CCT	Light output (±10%)lm	Length mm	CRI
--------------	-----	--------------------------	--------------	-----

**100-277V Non-dimming series**

ST-068-AW-WW-01C	2800-3100K	8580	1200	≥80
ST-068-AW-NW-01C	3800-4250K	8660	1200	≥80
ST-068-AW-WW-01C	4750-5300K	8880	1200	≥80
ST-068-AW-WW-02C	5700-6500K	8880	1200	≥80
ST-068-AW-WW-01C	2800-3100K	7480	1200	≥80
ST-068-AW-NW-01C	3800-4250K	7500	1200	≥80
ST-068-AW-WW-01C	4750-5300K	8020	1200	≥80
ST-068-AW-WW-02C	5700-6500K	8020	1200	≥80

**0-10V Dimmers Series**

STD-068-AW-WW-01C	2800-3100K	8612	1200	≥80
STD-068-AW-NW-01C	3800-4250K	8665	1200	≥80
STD-068-AW-WW-01C	4750-5300K	8723	1200	≥80
STD-068-AW-WW-02C	5700-6500K	8760	1200	≥80
STD-068-AW-WW-01C	2800-3100K	7385	1200	≥80
STD-068-AW-NW-01C	3800-4250K	7680	1200	≥80
STD-068-AW-WW-01C	4750-5300K	7723	1200	≥80
STD-068-AW-WW-02C	5700-6500K	7668	1200	≥80

**Microwave Sensing Series**

STM-068-AW-WW-01C	2800-3100K	8612	1200	≥80
STM-068-AW-NW-01C	3800-4250K	8665	1200	≥80
STM-068-AW-WW-01C	4750-5300K	8723	1200	≥80
STM-068-AW-WW-02C	5700-6500K	8760	1200	≥80
STM-068-AW-WW-01C	2800-3100K	7385	1200	≥80
STM-068-AW-NW-01C	3800-4250K	7680	1200	≥80
STM-068-AW-WW-01C	4750-5300K	7723	1200	≥80
STM-068-AW-WW-02C	5700-6500K	7668	1200	≥80



# Ceiling Light & Downlight



■ Ceiling Light Series .....	193-194
■ Recessed Downlight Series .....	195-196
■ Eslim SMD LED Downlight Series .....	197-198
■ Dolux Downlight Series .....	199-200
■ Luna Downlight Series .....	201-204
■ iVAR COB Series .....	209-210
■ HAT LED Downlight .....	211-212
■ FU LED Downlight .....	213-214
■ SUN LED Downlight .....	215-218
■ DISC Surface Mount Downlight .....	219-220
■ Capic Retrofit Downlight .....	221-222
■ Disk ultraslim Downlight .....	223-224
■ COB LED Downlight .....	225-226
■ LED Gimble downlight .....	227-230

# Ceiling Light

Lamp cover adopt PC material, crash-proof,UV-resistant

No mercury,no UV,no IR. No glare, soft light

Novel and unique shape design, elegant appearance;

Adopt microwave sensor control:  
Sensing distance: 5m,  
Sensor angle: 360°,  
Time delay: 60seconds



Size:(mm) 12W

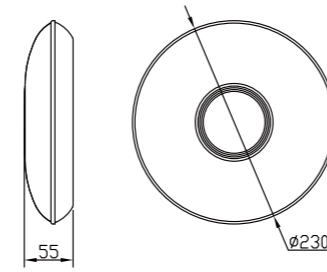

Model number	CCT	Light output CRI (±10%/lm)	
XD-012-AW-WW-01F	3000K	800	>80
XD-012-AW-NW-01F	4000K	850	>80
XD-012-AW-W-01F	5000K	850	>80

Size:(mm) 18W

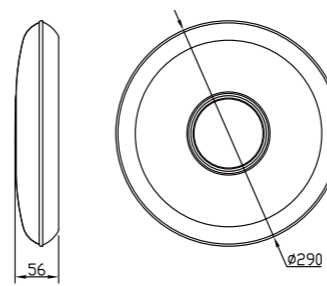

Model number	CCT	Light output CRI (±10%/lm)	
XD-018-AW-WW-01F	3000K	1260	>80
XD-018-AW-NW-01F	4000K	1350	>80
XD-018-AW-W-01F	5000K	1350	>80

Size:(mm) 25W

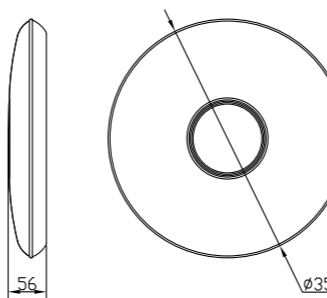

Model number	CCT	Light output CRI (±10%/lm)	
XD-025-AW-WW-01F	3000K	1750	>80
XD-025-AW-NW-01F	4000K	1875	>80
XD-025-AW-W-01F	5000K	1875	>80

# Recessed LED Downlight



Professionally treated die-casting  
a-alloy housing

The separate design of power  
supply and the main body,  
further prolonged their lifespan.

Size:(mm) 8W

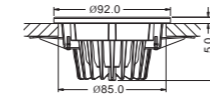

Size:(mm) 16W

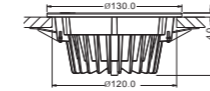

Size:(mm) 25W

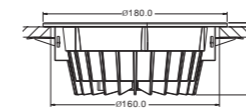

Size:(mm) 25W



Size:(mm) 35W

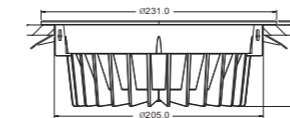

Model number	CCT	Light output ±10%/lm	CRI
DLD4-008-AW-W	5000K	550	>80
DLD4-008-AW-NW	4000K	520	>80
DLD4-008-AW-WW	3000K	450	>80

Model number	CCT	Light output ±10%/lm	CRI
DLD5-016-AW-W	5000K	1200	>80
DLD5-016-AW-NW	4000K	1000	>80
DLD5-016-AW-WW	3000K	870	>80

Model number	CCT	Light output ±10%/lm	CRI
DLD6-025-AW-W	5000K	1840	>80
DLD6-025-AW-NW	4000K	1250	>80
DLD6-025-AW-WW	3000K	1620	>80

Model number	CCT	Light output ±10%/lm	CRI
DLD7-030-AW-W	5000K	2220	>80
DLD7-030-AW-NW	4000K	1760	>80
DLD7-030-AW-WW	3000K	2000	>80

Model number	CCT	Light output ±10%/lm	CRI
DLD8-035-AW-W	5000K	2590	>80
DLD8-035-AW-NW	4000K	1830	>80
DLD8-035-AW-WW	3000K	2260	>80



# Eslim SMD LED Downlight Series

Ultra slim, thickness <26mm

Die-casting aluminum alloy housing, matt white

Opal diffuser make light beam uniform and low glare.



Size:(mm) 8W Cut size:Ø100mm

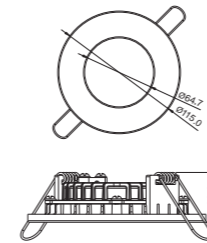

Model number CCT Light output CRI  
(±10%/lm)

FDL4-008-AW-W-01	5500-7000K	500	>80
FDL4-008-AW-NW-01	4000-4500K	490	>80
FDL4-008-AW-WW-01	2700-3200K	420	>80

**Bluetooth Dimming**

TFDL4-008-AW-W-01	5500-7000K	512	>80
TFDL4-008-AW-NW-01	4000-4500K	516	>80
TFDL4-008-AW-WW-01	2700-3200K	510	>80

Size:(mm) 12W Cut size:Ø130mm

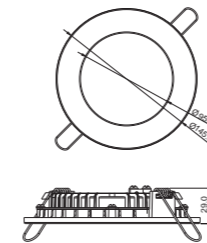

Model number CCT Light output CRI  
(±10%/lm)

FDL5-012-AW-W-01	5500-7000K	850	>80
FDL5-012-AW-NW-01	4000-4500K	870	>80
FDL5-012-AW-WW-01	2700-3200K	740	>80

**Bluetooth Dimming**

TFDL5-012-AW-W-01	5500-7000K	920	>80
TFDL5-012-AW-NW-01	4000-4500K	930	>80
TFDL5-012-AW-WW-01	2700-3200K	920	>80

Size:(mm) 18W Cut size:Ø165mm

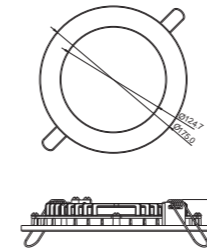

Model number CCT Light output CRI  
(±10%/lm)

FDL6-018-AW-W-01	5500-7000K	1370	>80
FDL6-018-AW-NW-01	4000-4500K	1400	>80
FDL6-018-AW-WW-01	2700-3200K	1220	>80

**Bluetooth Dimming**

TFDL6-018-AW-W-01	5500-7000K	1410	>80
TFDL6-018-AW-NW-01	4000-4500K	1420	>80
TFDL6-018-AW-WW-01	2700-3200K	1420	>80

Size:(mm) 24W Cut size:Ø200mm

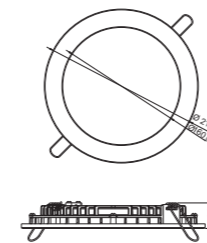

Model number CCT Light output CRI  
(±10%/lm)

FDL8-024-AW-W-01	5500-7000K	2130	>80
FDL8-024-AW-NW-01	4000-4500K	2040	>80
FDL8-024-AW-WW-01	2700-3200K	1750	>80

**Bluetooth Dimming**

TFDL8-024-AW-W-01	5500-7000K	2080	>80
TFDL8-024-AW-NW-01	4000-4500K	2070	>80
TFDL8-024-AW-WW-01	2700-3200K	2050	>80

Size:(mm) 30W Cut size:Ø235mm

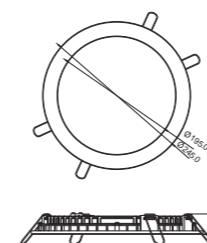

Model number CCT Light output CRI  
(±10%/lm)

FDL9-030-AW-W-01	5500-7000K	2620	>80
FDL9-030-AW-NW-01	4000-4500K	2520	>80
FDL9-030-AW-WW-01	2700-3200K	2240	>80

**Bluetooth Dimming**

TFDL9-030-AW-W-01	5500-7000K	2650	>80
TFDL9-030-AW-NW-01	4000-4500K	2660	>80
TFDL9-030-AW-WW-01	2700-3200K	2630	>80

# Dolux Downlight Series



Self -designed radiator with high efficiency to ensure COB work in low temperature .



Size:(mm)

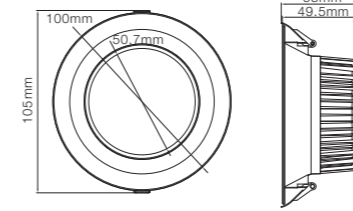

Model number	CCT	Power	Lumen (±10%)lm	Beam angle	Voltage	CRI
QDL3-005-AW-01	5000/4000/3000	5	430	50°		>80
QDL3-007-AW-01	5000/4000/3000	7	500	50°	100-240V AC	>80
QDL3-009-AW-01	5000/4000/3000	9	650	50°	50/60Hz	>80
QDL3-012-AW-01	5000/4000/3000	12	920	50°		>80



Size:(mm)

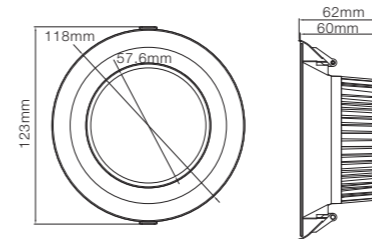

Model number	CCT	Power	Lumen (±10%)lm	Beam angle	Voltage	CRI
QDL4-007-AW-01	5000/4000/3000	7	550	60°		>80
QDL4-009-AW-01	5000/4000/3000	9	690	60°	100-240V AC	>80
QDL4-012-AW-01	5000/4000/3000	12	1000	60°	50/60Hz	>80
QDL4-015-AW-01	5000/4000/3000	15	1150	60°		>80



Size:(mm)

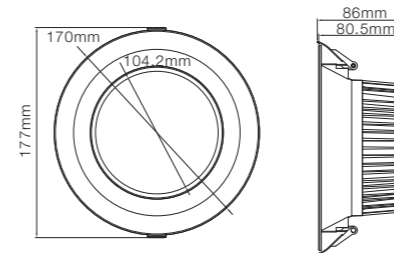

Model number	CCT	Power	Lumen (±10%)lm	Beam angle	Voltage	CRI
QDL6-012-AW-01	5000/4000/3000	12	1150	60°		>80
QDL6-018-AW-01	5000/4000/3000	18	1700	60°	100-240V AC	>80
QDL6-025-AW-01	5000/4000/3000	25	2250	60°	50/60Hz	>80
QDL6-030-AW-01	5000/4000/3000	30	2850	60°		>80



Size:(mm)

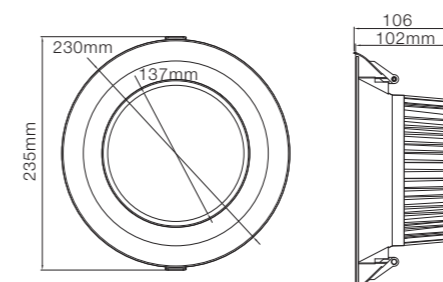

Model number	CCT	Power	Lumen (±10%)lm	Beam angle	Voltage	CRI
QDL8-018-AW-01	5000/4000/3000	18	1700	80°		>80
QDL8-025-AW-01	5000/4000/3000	25	2350	80°	100-240V AC	>80
QDL8-030-AW-01	5000/4000/3000	30	2700	80°	50/60Hz	>80
QDL8-035-AW-01	5000/4000/3000	35	3150	80°		>80



# Luna PAR16 Series

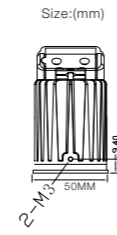

Model number	CCT	Light output (±10%)lm	CRI
DLP16-005-AW-W-01	5000K	370	>80
DLP16-005-AW-NW-01	4000K	400	>80
DLP16-005-AW-WW-01	3000K	380	>80
DLP16-007-AW-W-01	5000K	510	>80
DLP16-007-AW-NW-01	4000K	570	>80
DLP16-007-AW-WW-01	3000K	500	>80
DLP16-009-AW-W-01	5000K	780	>80
DLP16-009-AW-NW-01	4000K	830	>80
DLP16-009-AW-WW-01	3000K	750	>80

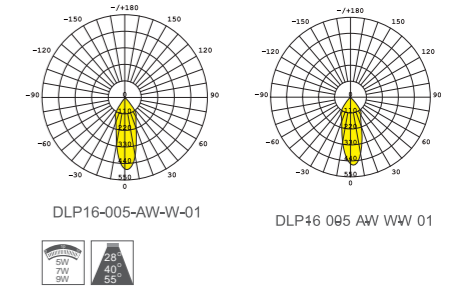

With 4 different lamp housings





# Luna COB Series



High light efficiency Epistar chip, 120lm/W

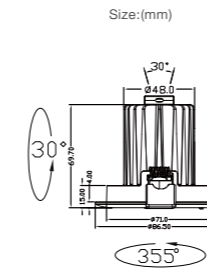

Model number	CCT	Light output (±10%)lm	CRI
MDL3 -005-AW-W-01	5000K	370	>80
MDL3 -005-AW-NW-01	4000K	400	>80
MDL3-005-AW-WW-01	3000K	380	>80
MDL3 -007-AW-W-01	5000K	510	>80
MDL3 -007-AW-NW-01	4000K	570	>80
MDL3-007-AW-WW-01	3000K	500	>80
MDL3-009-AW-W-01	5000K	780	>80
MDL3-009-AW-NW-01	4000K	830	>80
MDL3 -009-AW-WW-01	3000K	750	>80

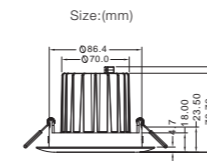
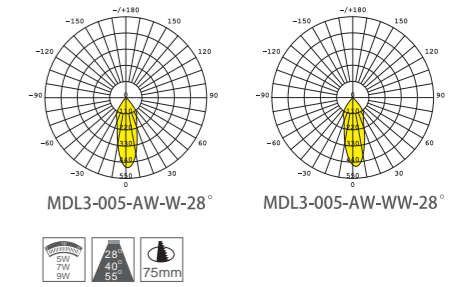

Model number	CCT	Light output (±10%)lm	CRI
MDL35-010-AW-WW-01	3000K	780	>80
MDL35-010-AW-NW-01	4000K	820	>80
MDL35-015-AW-WW-01	3000K	1235	>80
MDL35-015-AW-NW-01	4000K	1225	>80

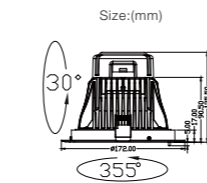
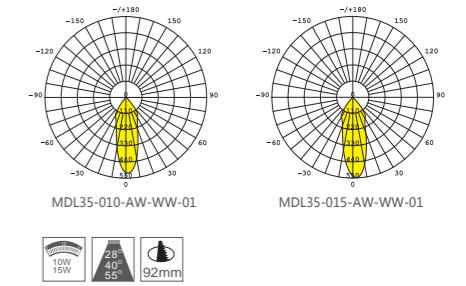

Model number	CCT	Light output (±10%)lm	CRI
MDL6-025-AW-W-01	5000K	2720	>80
MDL6-025-AW-NW-01	4000K	2660	>80
MDL6-025-AW-WW-01	3000K	2610	>80

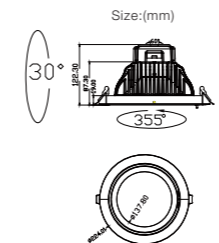
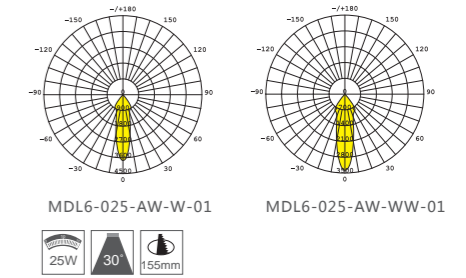

Model number	CCT	Light output (±10%)lm	CRI
MDL8-035-AW-W-01	5000K	4360	>80
MDL8-035-AW-NW-01	4000K	4300	>80
MDL8-035-AW-WW-01	3000K	4200	>80

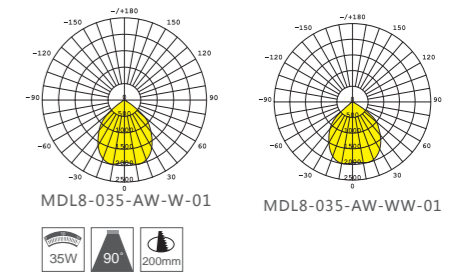

# Luna COB Downlight Series simulation



Position of surface in room:  
Marked point:  
(0.000 m, 0.000 m, 0.400 m)

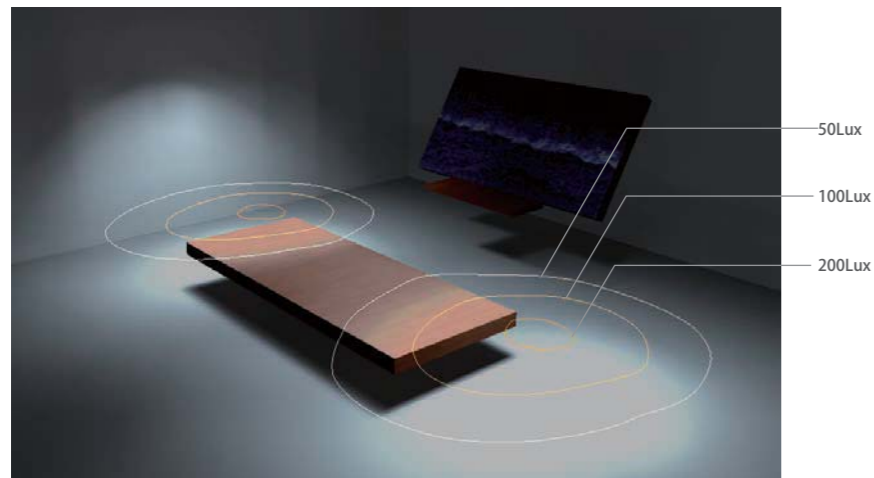
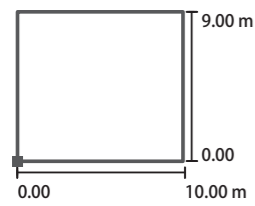

Grid: 128 x 128 Points

$E_{av}$ [lx]	$E_{min}$ [lx]	$E_{max}$ [lx]	u0	$E_{min} / E_{max}$
13	0.26	229	0.020	0.001



## Application

As lighting requirement improved, the lighting efficiency is also high required; especially in those places with high ceiling, such as hotel lobby, airport, shopping mall, retail shop, museum, etc; needing LED with high efficiency. LUNA COB developed at the right moment, its light efficiency can be up to 120 lm/W@35W, and can replace 70W metal halide down light, energy-saving up to 50%. In addition, it can rotate 358 ° horizontally, and 30° vertically, light up any blind angle.

## Luna COB Serie



### Luna COB Downlight 6" 25W

5000K  
CRI 82

Perfectly blended with ceiling and decoration; distance between lamps is 2 meters, and desk illuminance up to 500lux, meet illuminance requirement of office environment. CRI 82, can truly reflect furniture color, and no damage to eyes.

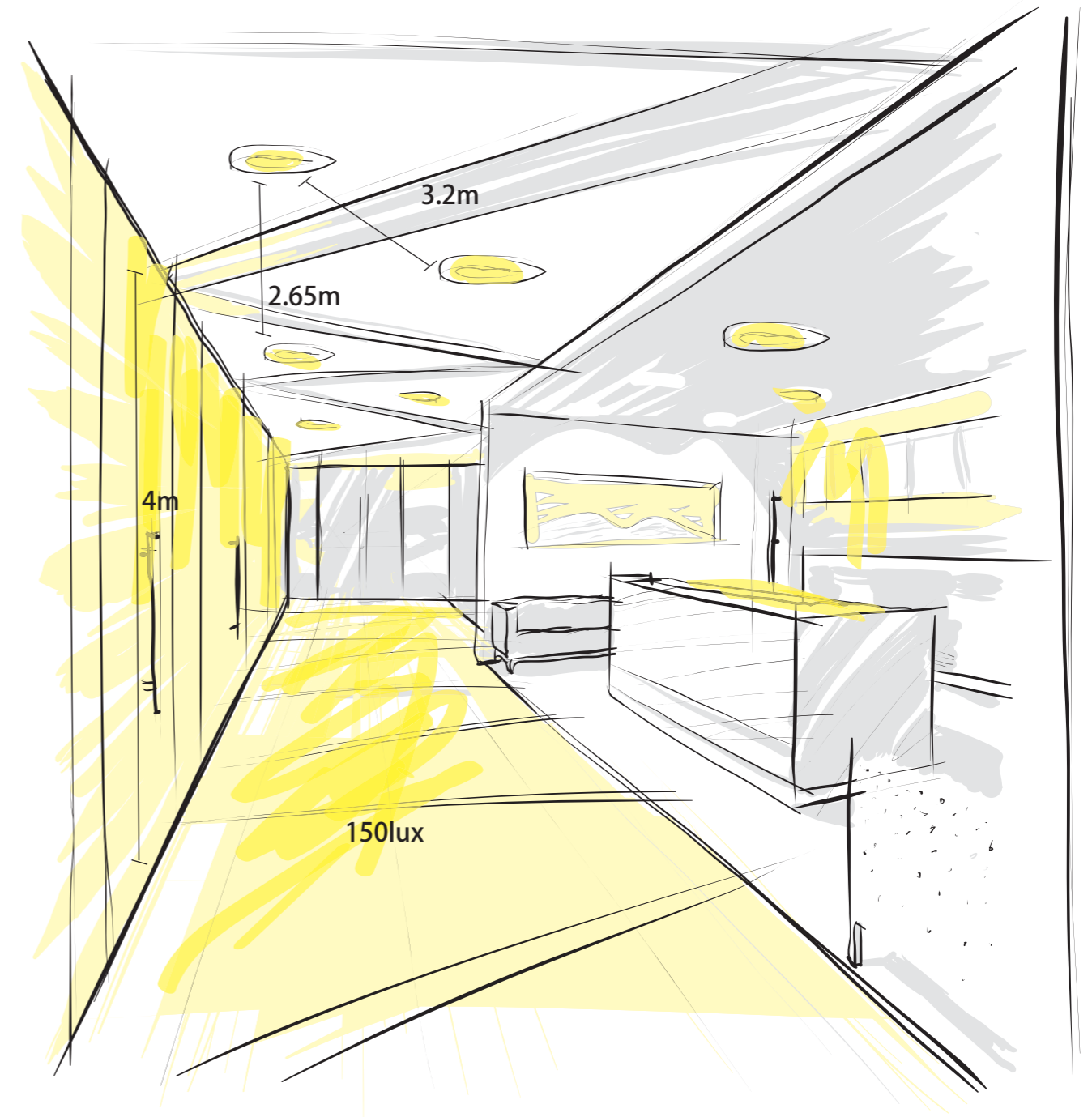

### Eslim SMD Downlight 9" 30W

4000K  
CRI 82

4m ceiling height, 2.65-3.2m lamp distance, ground illuminance 150LUX.  
soft and uniform light, bright environment.

# iVAR COB Series

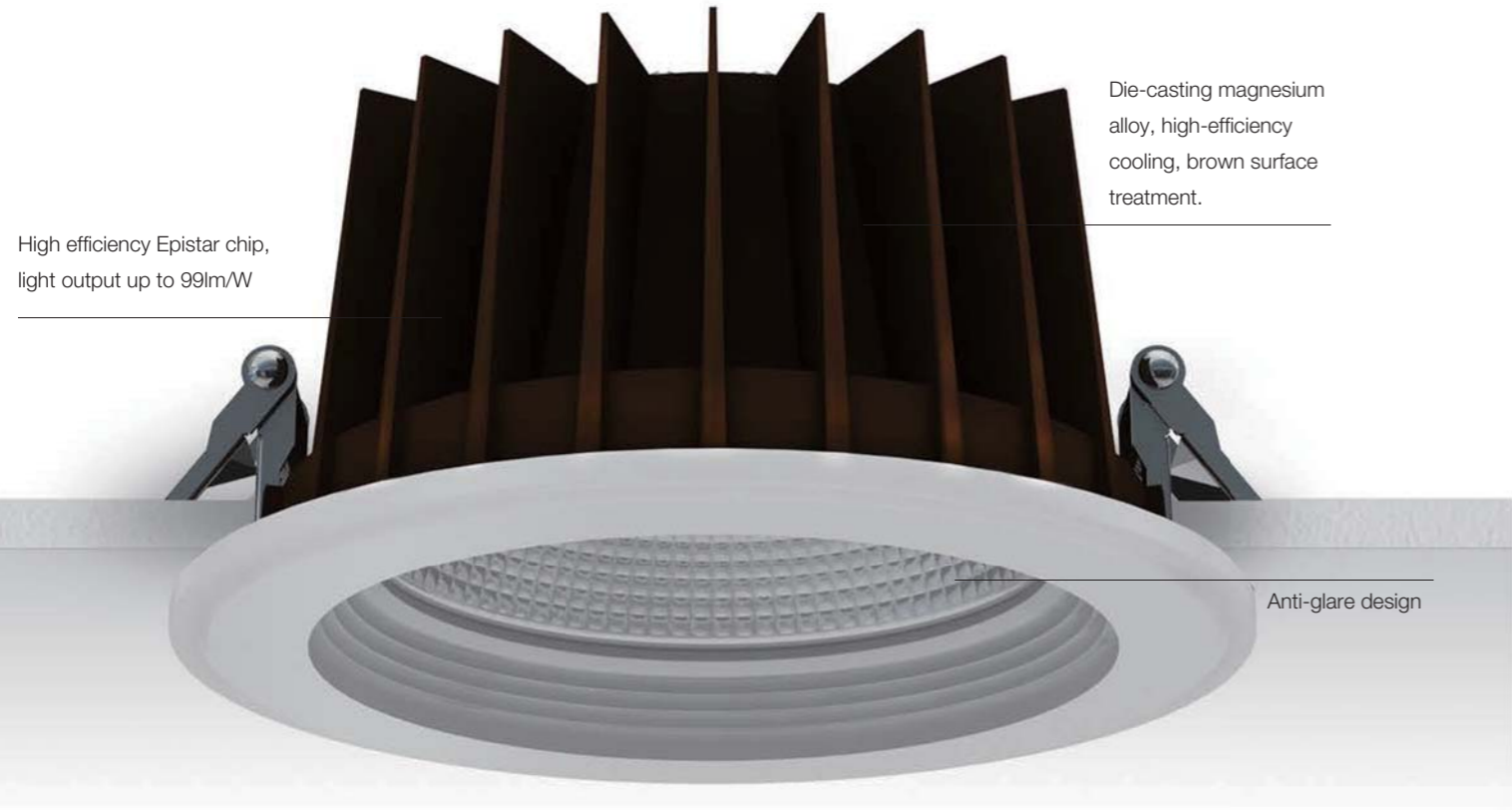

High efficiency Epistar chip,  
light output up to 99lm/W

Die-casting magnesium alloy, high-efficiency cooling, brown surface treatment.

Anti-glare design



High light efficiency Epistar chip, 90lm/W



Size:(mm) 9W Cut size:Ø95mm

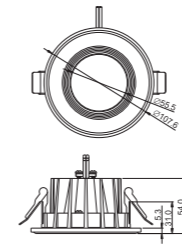

Model number	CCT	Light output ±10%/lm	CRI
DLD04-009-AW-W-01	5000K	760	>80
DLD04-009-AW-WW-01	3000K	720	>80
DLD04-009-AW-NW-01	4000K	830	>80

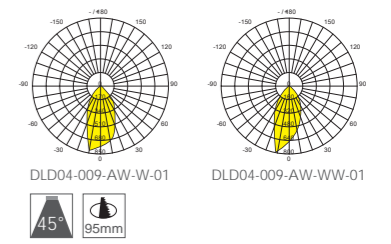

Size:(mm) 15W Cut size:Ø125mm

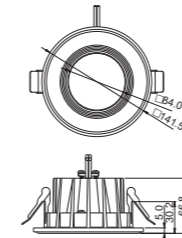

Model number	CCT	Light output ±10%/lm	CRI
DLD05-015-AW-W-01	5000K	1160	>80
DLD05-015-AW-WW-01	3000K	1100	>80
DLD05-015-AW-NW-01	4000K	1330	>80

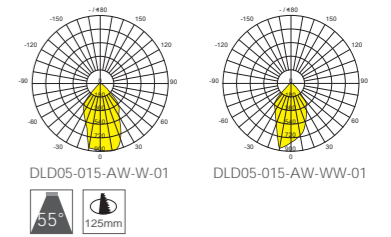

Size:(mm) 20W Cut size:Ø140mm

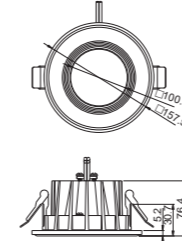

Model number	CCT	Light output ±10%/lm	CRI
DLD06-020-AW-W-01	5000K	1530	>80
DLD06-020-AW-WW-01	3000K	1300	>80
DLD06-020-AW-NW-01	4000K	1590	>80

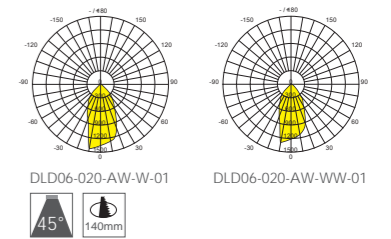

Size:(mm) 25W Cut size:Ø170mm

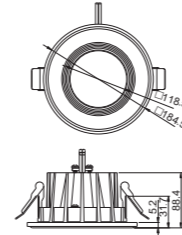

Model number	CCT	Light output ±10%/lm	CRI
DLD07-025-AW-W-01	5000K	2480	>80
DLD07-025-AW-WW-01	3000K	2260	>80
DLD07-025-AW-NW-01	4000K	2440	>80

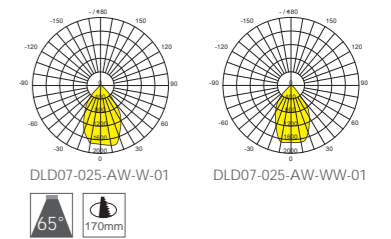

Size:(mm) 35W Cut size:Ø210mm

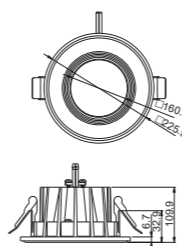

Model number	CCT	Light output ±10%/lm	CRI
DLD08-035-AW-W-01	5000K	3060	>80
DLD08-035-AW-WW-01	3000K	2960	>80
DLD08-035-AW-NW-01	4000K	3200	>80

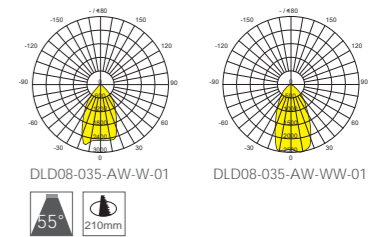

# HAT 4" / 5-6" LED Retrofit Downlight



Unique appearance, beautiful design and gorgeous

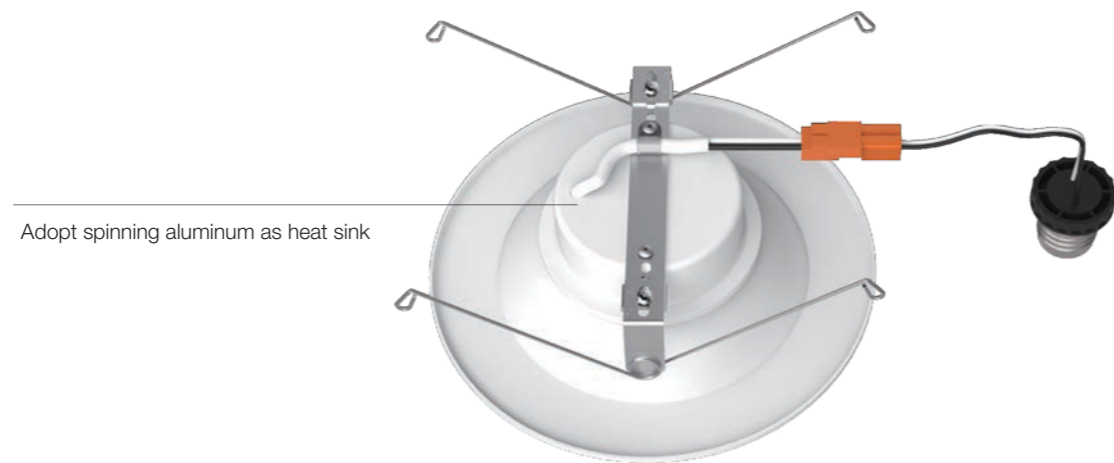

Adopt spinning aluminum as heat sink



4 inch(smooth)



4 inch(baffle)



5-6 inch(smooth)



5-6 inch(baffle)

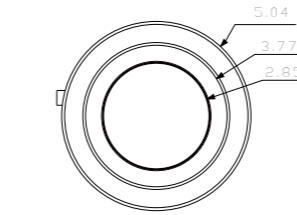
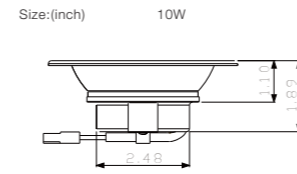

Size:(inch) 10W

Model nubmer	CCT	Light output (±10%)lm	CRI
HTL4-010-AL-927K-01	2700K	600	>90
HTL4-010-AL-930K-01	3000K	610	>90
HTL4-010-AL-940K-01	4000K	700	>90
HTL4-010-AL-950K-01	5000K	700	>90

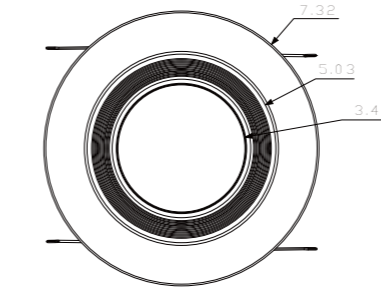
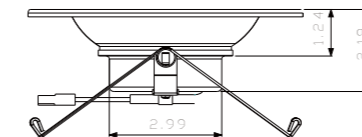

Size:(inch) 15W

Model nubmer	CCT	Light output (±10%)lm	CRI
HTL6-015-AL-927K-01	2700K	1000	>90
HTL6-015-AL-930K-01	3000K	1020	>90
HTL6-015-AL-940K-01	4000K	1050	>90
HTL6-015-AL-950K-01	5000K	1100	>90

# FU LED Downlight

Full plastic appearance, gloss and brilliant white shows high-end and elegance.



Radiator with aluminum enclosed with plastic, safe and reliable

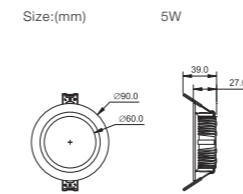

Model nubmer	CCT	Light output (±10%)lm	CRI
FU3-005-AW-WW-01	3000K	430	>80
FU3-005-AW-NW-01	4000K	450	>80
FU3-005-AW-W-01	6500K	430	>80

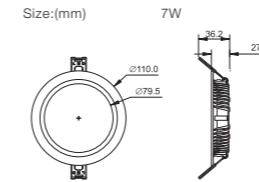

Model nubmer	CCT	Light output (±10%)lm	CRI
FU4-007-AW-WW-01	3000K	580	>80
FU4-007-AW-NW-01	4000K	600	>80
FU4-007-AW-W-01	6500K	600	>80

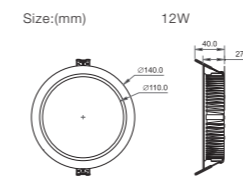

Model nubmer	CCT	Light output (±10%)lm	CRI
FU5-012-AW-WW-01	3000K	1030	>80
FU5-012-AW-NW-01	4000K	1080	>80
FU5-012-AW-W-01	6500K	1060	>80

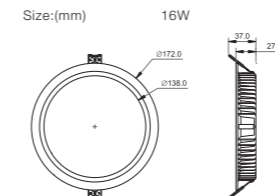

Model nubmer	CCT	Light output (±10%)lm	CRI
FU6-016-AW-WW-01	3000K	1590	>80
FU6-016-AW-NW-01	4000K	1680	>80
FU6-016-AW-W-01	6500K	1560	>80

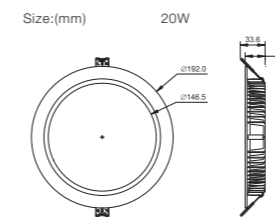

Model nubmer	CCT	Light output (±10%)lm	CRI
FU7-020-AW-WW-01	3000K	1800	>80
FU7-020-AW-NW-01	4000K	1890	>80
FU7-020-AW-W-01	6500K	1950	>80

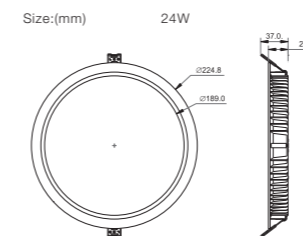

Model nubmer	CCT	Light output (±10%)lm	CRI
FU8-024-AW-WW-01	3000K	2360	>80
FU8-024-AW-NW-01	4000K	2400	>80
FU8-024-AW-W-01	6500K	2240	>80

# SUN LED Downlight (Surface mounted) IP65



The main material is aluminum 1050

High reflectance rate metal reflectors and transparent toughened glass



with rear cover material as galvanized sheet

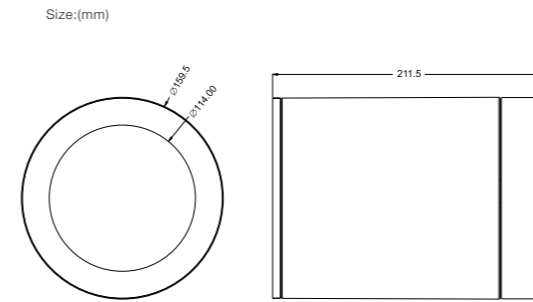

Model nubmer	CCT	Light output (±10%)lm	CRI
FMDL6-040-AH-WW-01	3000K	3500	>80
FMDL6-040-AH-NW-01	4000K	3800	>80
FMDL6-040-AH-W-01	5000K	3900	>80



# SUN LED Downlight (Surface mounted & Suspended Installation)

The light covers and tail covers are fixed through emboss rotating cooperation fixation, allowing simple assembly and efficient production.

main material is aluminum alloy, shear spinning process with one-time molding



COB adopts high reflective rate metal reflection cup and transparent tempered glass

COB LED Type



SMD LED Type



Size:(mm) COB LED Type

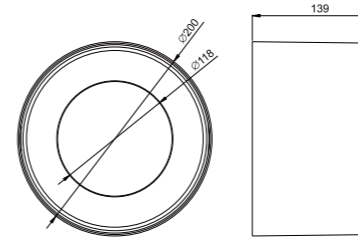
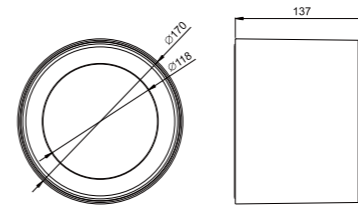
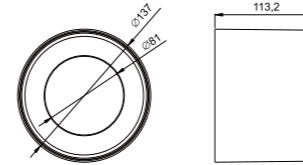
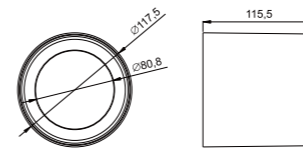

Size:(mm) SMD LED Type

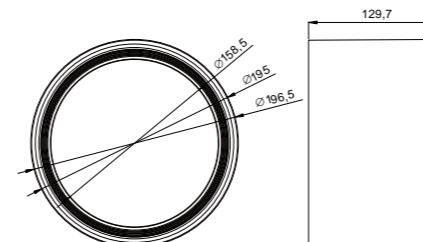
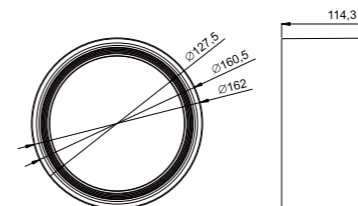
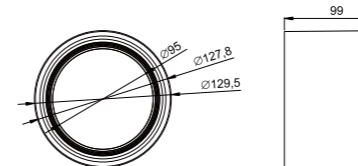

Model number	CCT	Light output CRI (±10%)lm	
FMDL4-012-AH-WW-01	3000K	1000	>80
FMDL4-012-AH-NW-01	4000K	1050	>80
FMDL4-012-AH-W-01	5000K	1000	>80
FMDL4-015-AH-WW-01	3000K	1230	>80
FMDL4-015-AH-NW-01	4000K	1270	>80
FMDL4-015-AH-W-01	5000K	1200	>80

Model number	CCT	Light output CRI (±10%)lm	
FMDL5-020-AH-WW-01	3000K	1650	>80
FMDL5-020-AH-NW-01	4000K	1860	>80
FMDL5-020-AH-W-01	5000K	1800	>80

Model number	CCT	Light output CRI (±10%)lm	
FMDL6-025-AH-WW-01	3000K	2180	>80
FMDL6-025-AH-NW-01	4000K	2440	>80
FMDL6-025-AH-W-01	5000K	2450	>80

Model number	CCT	Light output CRI (±10%)lm	
FMDL8-030-AH-WW-01	3000K	2600	>80
FMDL8-030-AH-NW-01	4000K	2770	>80
FMDL8-030-AH-W-01	5000K	2680	>80

Model number	CCT	Light output CRI (±10%)lm	
FSDL5-010-AH-WW-01	3000K	850	>80
FSDL5-010-AH-NW-01	4000K	890	>80
FSDL5-010-AH-W-01	5000K	900	>80

Model number	CCT	Light output CRI (±10%)lm	
FSDL6-016-AH-WW-01	3000K	1720	>80
FSDL6-016-AH-NW-01	4000K	1770	>80
FSDL6-016-AH-W-01	5000K	1790	>80

Model number	CCT	Light output CRI (±10%)lm	
FSDL8-025-AH-WW-01	3000K	2840	>80
FSDL8-025-AH-NW-01	4000K	2890	>80
FSDL8-025-AH-W-01	5000K	3020	>80



# DISC LED Surface Mount Downlight



Adopt spinning aluminum as heat sink,  
High efficiency and energy-saving LED driver

Unique appearance, beautiful  
design and gorgeous



This product is suitable for use in dimming circuit.  
For 5-100% light control, use with a compatible dimmer.  
Compatible dimmers include most standard dimmers,  
such as Lutron :SCL-153P,CTCL-153P,DVCL-153P,MACL-153M.

Size:(mm) 15W

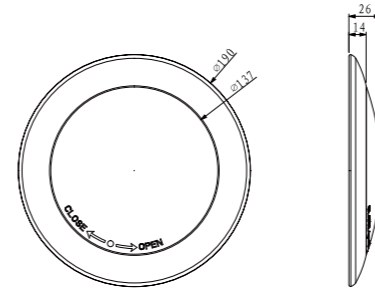

Model nubmer	CCT	Light output CRI (±10%)lm	
DSC6-015-AL-927K-01	2700K	980	>90
DSC6-015-AL-930K-01	3000K	1000	>90
DSC6-015-AL-940K-01	4000K	1020	>90
DSC6-015-AL-950K-01	5000K	1040	>90



# Capic Retrofit Downlight Series



Size:(mm) 9W / 12W

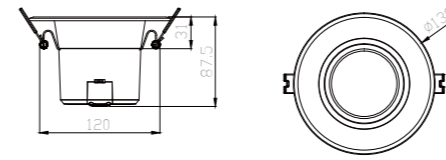

Size:(mm) 15W / 18W

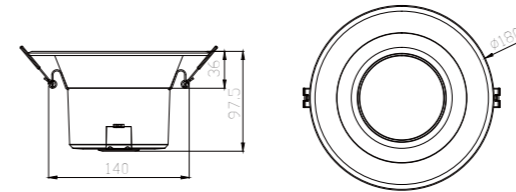

Size:(mm) 21W / 24W

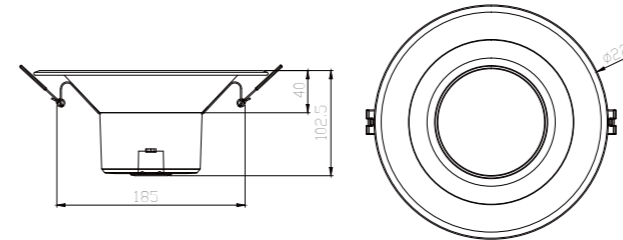

Model nubmer	CCT	Light output (±10%)lm	CRI
CPR4-009-AW-W-02	6500K	880	>80
CPR4-009-AW-W-01	5000K	890	>80
CPR4-009-AW-NW-01	4000K	920	>80
CPR4-009-AW-WW-01	3000K	840	>80
CPR4-012-AW-W-02	6500K	1500	>80
CPR4-012-AW-W-01	5000K	1600	>80
CPR4-012-AW-NW-01	4000K	1540	>80
CPR4-012-AW-WW-01	3000K	1400	>80

Model nubmer	CCT	Light output (±10%)lm	CRI
CPR6-015-AW-W-02	6500K	1540	>80
CPR6-015-AW-W-01	5000K	1560	>80
CPR6-015-AW-NW-01	4000K	1540	>80
CPR6-015-AW-WW-01	3000K	1410	>80
CPR6-018-AW-W-02	6500K	1620	>80
CPR6-018-AW-W-01	5000K	1660	>80
CPR6-018-AW-NW-01	4000K	1650	>80
CPR6-018-AW-WW-01	3000K	1520	>80

Model nubmer	CCT	Light output (±10%)lm	CRI
CPR8-021-AW-W-02	6500K	1710	>80
CPR8-021-AW-W-01	5000K	1740	>80
CPR8-021-AW-NW-01	4000K	1720	>80
CPR8-021-AW-WW-01	3000K	1570	>80
CPR8-024-AW-W-02	6500K	1710	>80
CPR8-024-AW-W-01	5000K	1740	>80
CPR8-024-AW-NW-01	4000K	1720	>80
CPR8-024-AW-WW-01	3000K	1570	>80



# Disk ultraslim Downlight Series

Excellent heat dissipation performance to ensure the long lifetime of LED

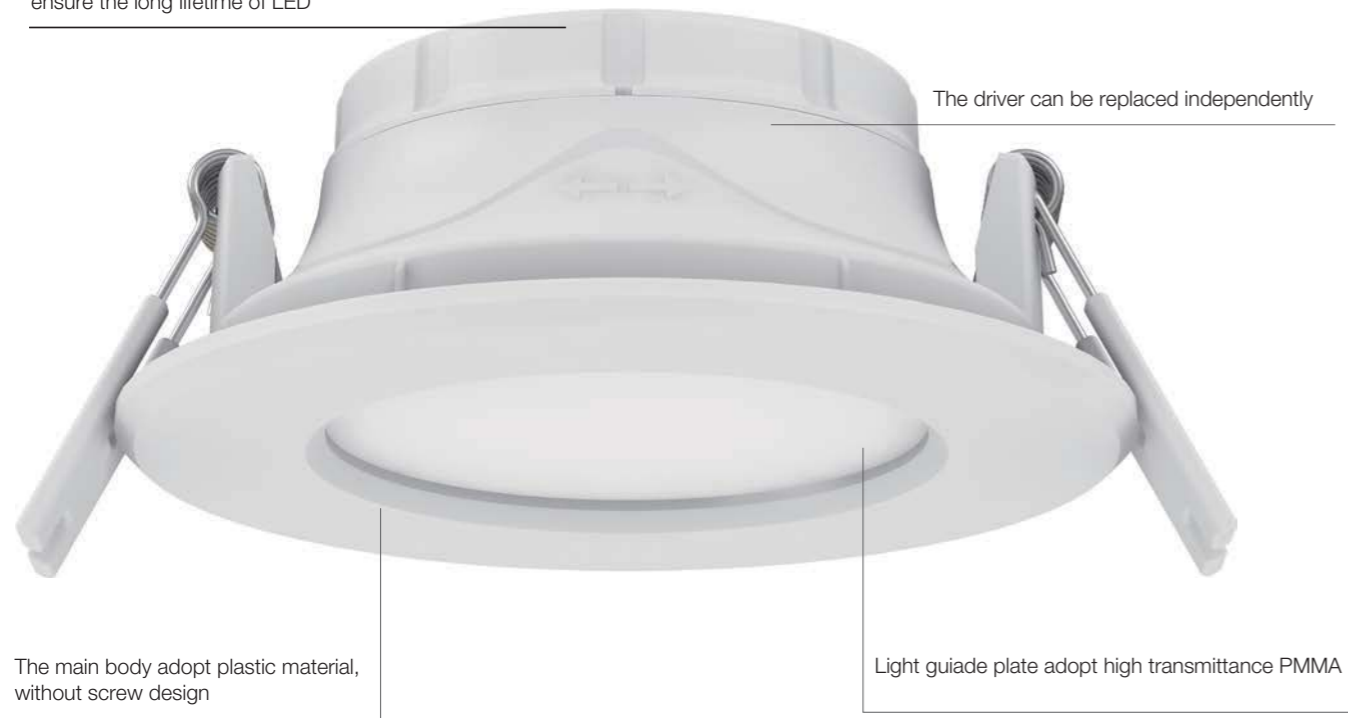

6 inch



8 inch

Size:(mm) 8W

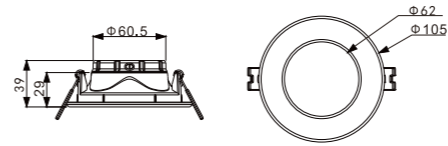

Size:(mm) 12W

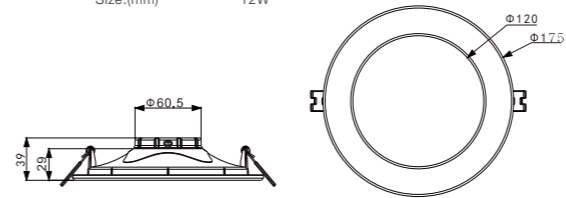

Size:(mm) 18W

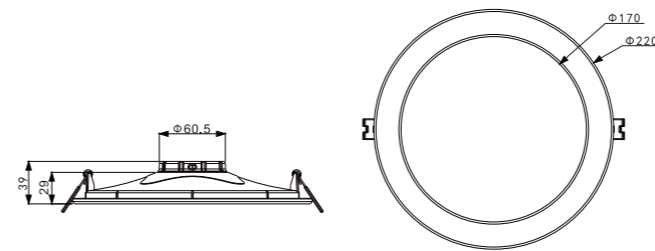

Model number	CCT	Light output (±10%)lm	CRI
<b>IP43</b>			
DKL4-008-AW-W-01	5000K	490	>80
DKL4-008-AW-NW-01	4000K	480	>80
DKL4-008-AW-WW-01	3000K	440	>80
DKL4-008-AW-W-01H	5000K	620	>80
DKL4-008-AW-NW-01H	4000K	610	>80
DKL4-008-AW-WW-01H	3000K	570	>80
<b>IP64</b>			
DKL4-008-AW-W-40	5000K	490	>80
DKL4-008-AW-NW-40	4000K	480	>80
DKL4-008-AW-WW-40	3000K	440	>80
DKL4-008-AW-W-40H	5000K	620	>80
DKL4-008-AW-NW-40H	4000K	610	>80
DKL4-008-AW-WW-40H	3000K	570	>80

Model number	CCT	Light output (±10%)lm	CRI
<b>IP43</b>			
DKL6-012-AW-W-01	5000K	890	>80
DKL6-012-AW-NW-01	4000K	880	>80
DKL6-012-AW-WW-01	3000K	860	>80
DKL6-012-AW-W-01H	5000K	1080	>80
DKL6-012-AW-NW-01H	4000K	1030	>80
DKL6-012-AW-WW-01H	3000K	980	>80
<b>IP64</b>			
DKL6-012-AW-W-40	5000K	890	>80
DKL6-012-AW-NW-40	4000K	880	>80
DKL6-012-AW-WW-40	3000K	860	>80
DKL6-012-AW-W-40H	5000K	1080	>80
DKL6-012-AW-NW-40H	4000K	1030	>80
DKL6-012-AW-WW-40H	3000K	980	>80

Model number	CCT	Light output (±10%)lm	CRI
<b>IP43</b>			
DKL8-018-AW-W-01	5000K	1410	>80
DKL8-018-AW-NW-01	4000K	1290	>80
DKL8-018-AW-WW-01	3000K	1260	>80
DKL8-018-AW-W-01H	5000K	1680	>80
DKL8-018-AW-NW-01H	4000K	1600	>80
DKL8-018-AW-WW-01H	3000K	1520	>80
<b>IP64</b>			
DKL8-018-AW-W-40	5000K	1410	>80
DKL8-018-AW-NW-40	4000K	1290	>80
DKL8-018-AW-WW-40	3000K	1260	>80
DKL8-018-AW-W-40H	5000K	1680	>80
DKL8-018-AW-NW-40H	4000K	1600	>80
DKL8-018-AW-WW-40H	3000K	1520	>80



# COB LED Downlight ELE Series

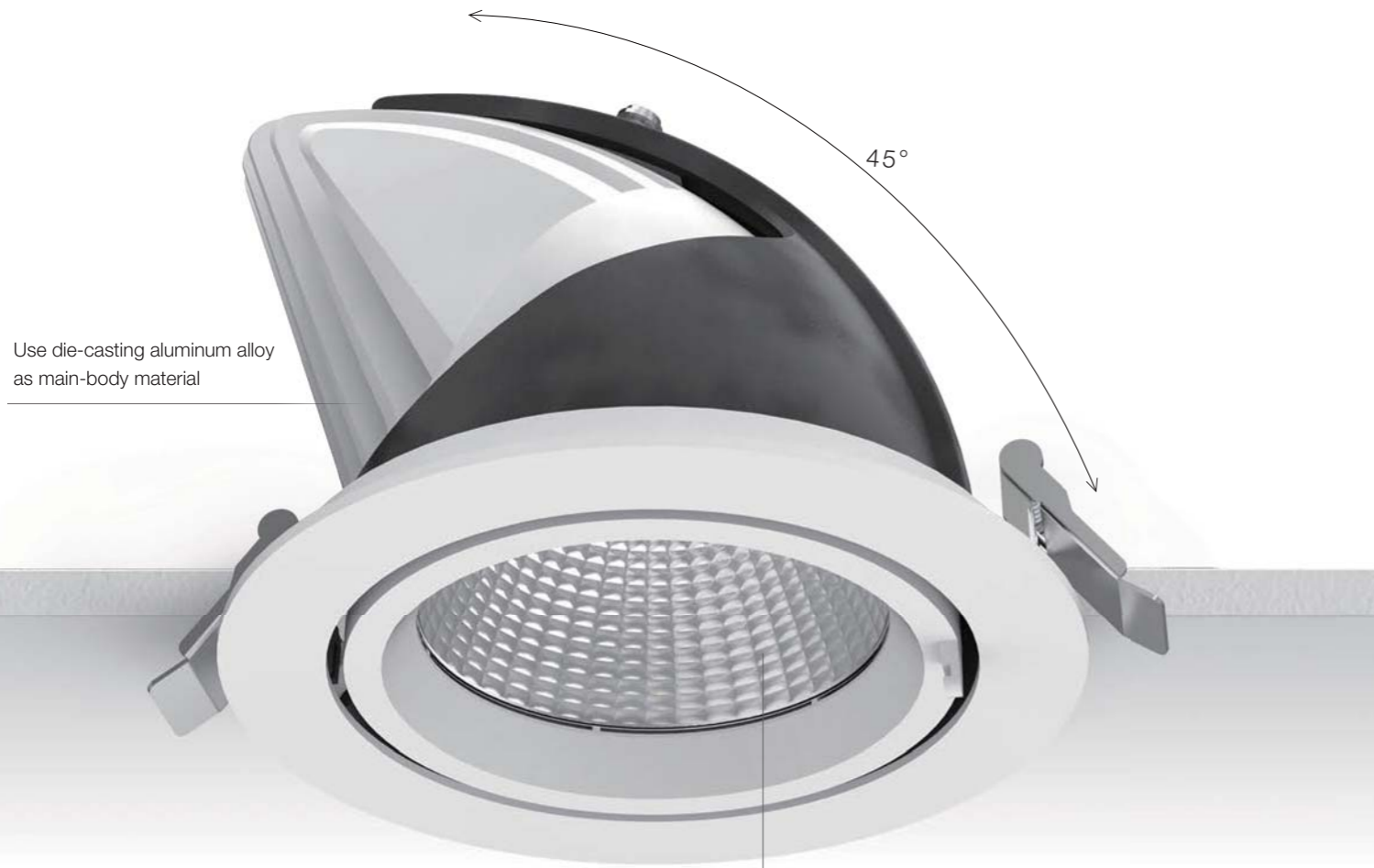

Adoption of Shinland efficient reflection cup + lens.  
The light spot is evener without overlapped light spots



Size:(mm) 20W

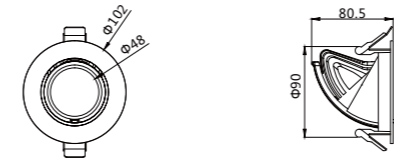

Size:(mm) 30W

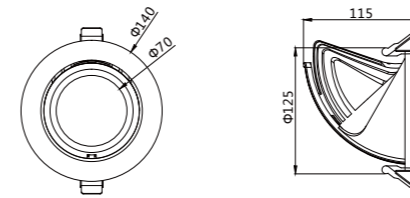

Size:(mm) 40W

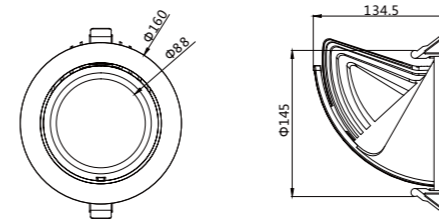

Model number	CCT	Light output (±10%/lm)	CRI
EDL4-020-AW-W-01	5000K	1960	>80
EDL4-020-AW-NW-01	4000K	1910	>80
EDL4-020-AW-WW-01	3000K	1760	>80
EDL4-020-AW-W-02	5000K	1800	>80
EDL4-020-AW-NW-02	4000K	1720	>80
EDL4-020-AW-WW-02	3000K	1600	>80
EDL4-020-AW-W-03	5000K	1810	>80
EDL4-020-AW-NW-03	4000K	1730	>80
EDL4-020-AW-WW-03	3000K	1610	>80

Model number	CCT	Light output (±10%/lm)	CRI
EDL5-030-AW-W-01	5000K	3500	>80
EDL5-030-AW-NW-01	4000K	3300	>80
EDL5-030-AW-WW-01	3000K	3060	>80
EDL5-030-AW-W-02	5000K	3040	>80
EDL5-030-AW-NW-02	4000K	2950	>80
EDL5-030-AW-WW-02	3000K	2530	>80
EDL5-030-AW-W-03	5000K	3010	>80
EDL5-030-AW-NW-03	4000K	2940	>80
EDL5-030-AW-WW-03	3000K	2660	>80

Model number	CCT	Light output (±10%/lm)	CRI
EDL6-040-AW-W-01	5000K	5070	>80
EDL6-040-AW-NW-01	4000K	4740	>80
EDL6-040-AW-WW-01	3000K	4600	>80
EDL6-040-AW-W-02	5000K	4290	>80
EDL6-040-AW-NW-02	4000K	4180	>80
EDL6-040-AW-WW-02	3000K	3830	>80
EDL6-040-AW-W-03	5000K	3680	>80
EDL6-040-AW-NW-03	4000K	4010	>80
EDL6-040-AW-WW-03	3000K	3950	>80



# LED Gimble downlight 100LM/W

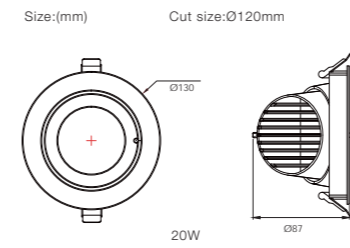

Model number	CCT	Light output (±10%/lm)	CRI
RDL4-020-AW-W	5000K	1920	>80
RDL4-020-AW-NW	4000K	1935	>80
RDL4-020-AW-WW	3000K	1887	>80

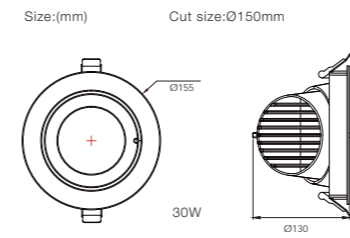
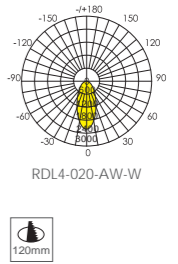

Model number	CCT	Light output (±10%/lm)	CRI
RDL5-030-AW-W	5000K	2718	>80
RDL5-030-AW-NW	4000K	2746	>80
RDL5-030-AW-WW	3000K	2688	>80

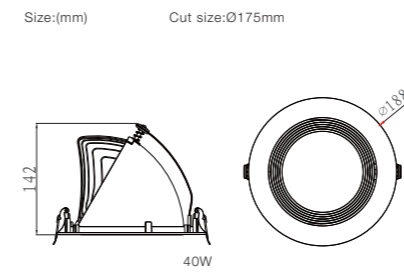
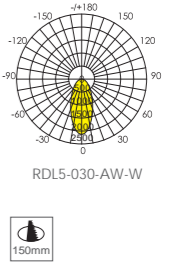

Model number	CCT	Light output (±10%/lm)	CRI
RDL6-040-AW-W-01	5000K	3797	>80
RDL6-040-AW-NW-01	4000K	3748	>80
RDL6-040-AW-WW-01	3000K	3591	>80
RDL6-040-AW-W-02	5000K	3651	>80
RDL6-040-AW-NW-02	4000K	3713	>80
RDL6-040-AW-WW-02	3000K	3479	>80

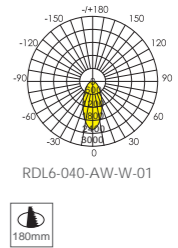

## LED Gimble downlight

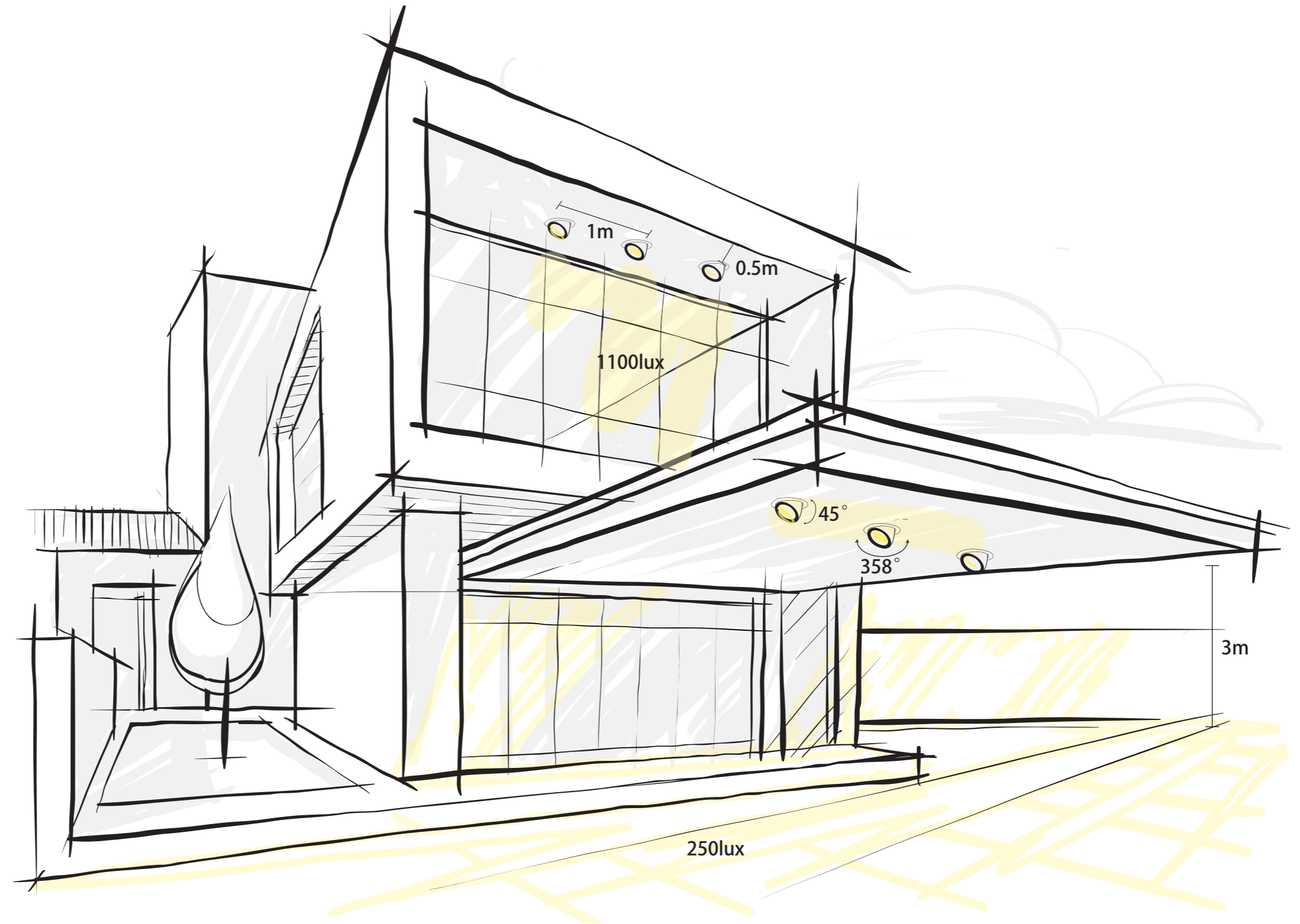

## COB Gimable Downlight 40W

5000K  
CRI 82

Perfectly blended with decoration style; lamp incline 45 degree, distance between lamps is 1m, and distance between lamp and glass is 0.5m; illuminance of glass wall is 1100lux, CRI 82, so perfectly highlight the clothing in show window.

# Track Light



■ Vero COB Track Light ..... 233-234

■ Kasa COB Track light ..... 235-238

# Vero COB Track Light



Pure aluminum 1070 driver box , matt white

Pure aluminum and die-cast aluminum for light body and driver box, perfect heat dissipation, low temperature working.

COB CRI82 and 93 available. Delivering a high light output **97lm/W** (CRI82)



Size:(mm) 10W

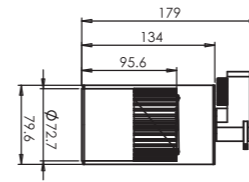
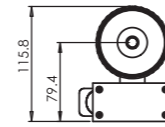

Size:(mm) 20W

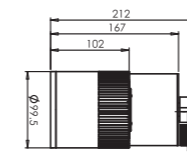
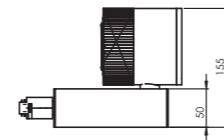
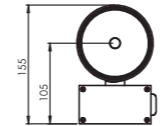

Size:(mm) 30W

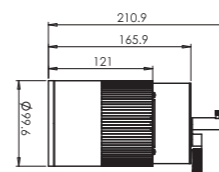
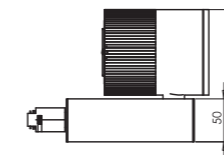
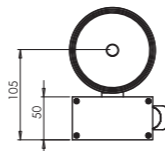

Model number	CCT	Light output (±10%)lm	CRI
TL-010-AW-W-01	5000K	790	>80
TL-010-AW-NW-01	4000K	740	>80
TL-010-AW-WW-01	3000K	730	>80

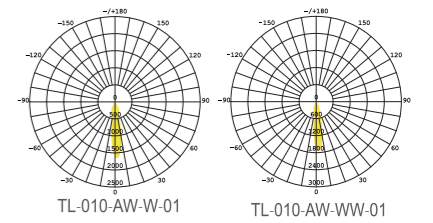

Model number	CCT	Light output (±10%)lm	CRI
TL-020-AW-W-01	5000K	1600	>80
TL-020-AW-NW-01	4000K	1500	>80
TL-020-AW-WW-01	3000K	1400	>80

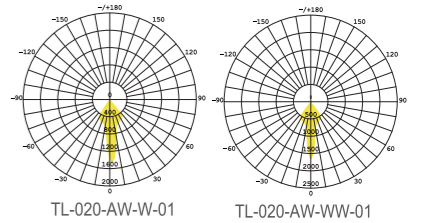

Model number	CCT	Light output (±10%)lm	CRI
TL-030-AW-W-01	5000K	2500	>80
TL-030-AW-NW-01	4000K	2900	>80
TL-030-AW-WW-01	3000K	2150	>80

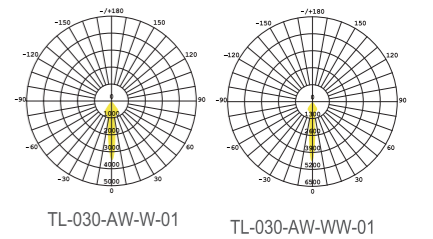



# Kasa COB Track light

## 70W Metal Halide Replacement

 Pure aluminum and die-cast aluminum for light body and driver box, perfect heat dissipation, low temperature working.

 CITIZEN COB CRI82 and 93 available. Delivering a high light output 97lm/W (CRI82)



CITIZEN COB , CRI82  
CRI93 available

Built-in heat sink and  
pure aluminum housing



Two colors optional

-  black
-  white



Size:(mm) 35W

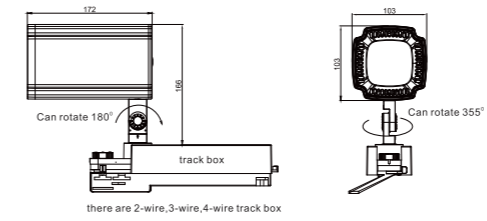

Model nubmer	CCT	Light output (±10%)lm	CRI
TK-035-AW-W-01	5000K	3100	>80
TK-035-AW-NW-01	4000K	3000	>80
TK-035-AW-WW-01	3000K	2900	>80

Size:(mm) 50W

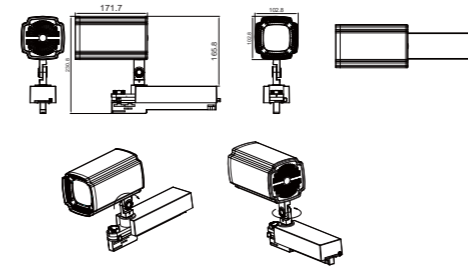

Model nubmer	CCT	Light output (±10%)lm	CRI
TK-050-AW-W-01	5000K	4750	>80
TK-050-AW-NW-01	4000K	4400	>80
TK-050-AW-WW-01	3000K	4000	>80

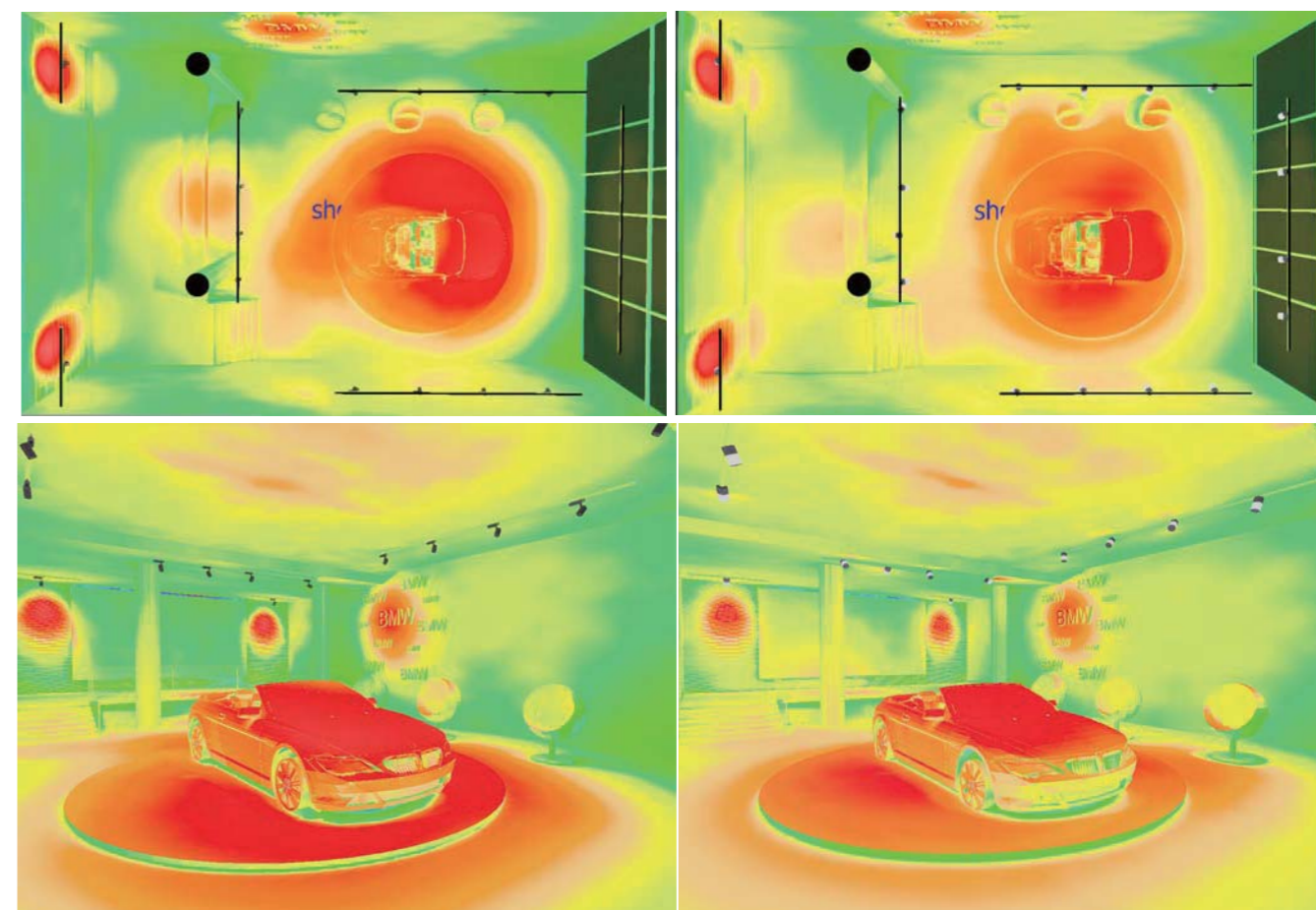

REQUIREMENTS	SPECIFICATIONS
EN 12464-1sub 5.4.1	floor surface 160 m <sup>2</sup>
General lighting 0.8m:300 lux	fixtures used 18
Accent lighting 1000 lux	mounting height 4.5meters
	Ra>80

	HID	KASA 50W
HID and KASA 50W		
Fixture power consumption(incl.ballast)	88(70+18)	50
Lifetime	20000	50000
Overall luxlevel on workplane(0.8m)	306	312
Showing-area	989	1150
Overall power consumption per m <sup>2</sup>	9.9w/m <sup>2</sup>	5.62w/m <sup>2</sup>

# PL Lamp



- PL Lamp ..... 241-242
- 360 degree PL Lamp ..... 243-244

# PL Lamp



## Size:(mm) 90LM/W Series

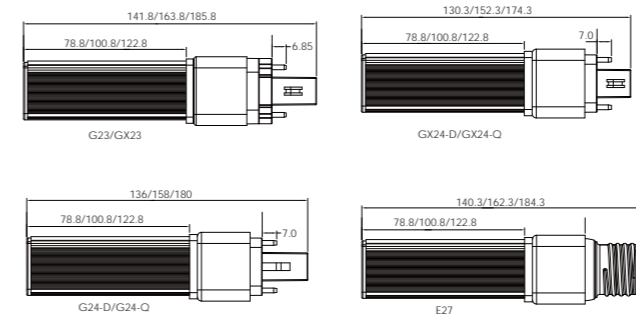

Model number	CCT	Light output (±10%/lm)	CRI
PL-006-AW-W-01	5000K	450	>80
PL-006-AW-NW-01	4000K	600	>80
PL-006-AW-WW-01	3000K	480	>80
PL-006-AW-W-02	5000K	400	>80
PL-006-AW-NW-02	4000K	530	>80
PL-006-AW-WW-02	3000K	425	>80
PL-008-AW-W-01	5000K	620	>80
PL-008-AW-NW-01	4000K	660	>80
PL-008-AW-WW-01	3000K	640	>80
PL-008-AW-W-02	5000K	550	>80
PL-008-AW-NW-02	4000K	585	>80
PL-008-AW-WW-02	3000K	570	>80
PL-010-AW-W-01	5000K	780	>80
PL-010-AW-NW-01	4000K	880	>80
PL-010-AW-WW-01	3000K	830	>80
PL-010-AW-W-02	5000K	690	>80
PL-010-AW-NW-02	4000K	780	>80
PL-010-AW-WW-02	3000K	735	>80

## Size:(mm) 120LM/W Series

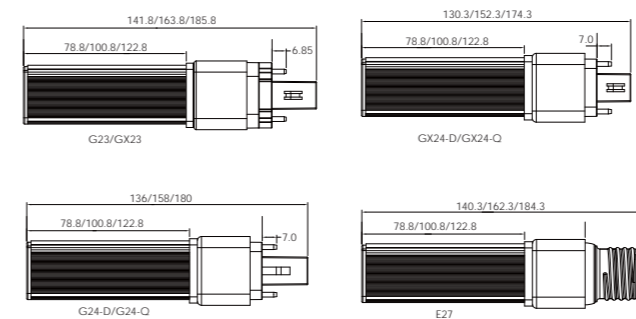

Model number	CCT	Light output (±10%/lm)	CRI
PL-006-AW-W-03	5000K	670	>80
PL-006-AW-NW-03	4000K	650	>80
PL-006-AW-WW-03	3000K	620	>80
PL-006-AW-W-04	5000K	600	>80
PL-006-AW-NW-04	4000K	580	>80
PL-006-AW-WW-04	3000K	550	>80
PL-008-AW-W-03	5000K	900	>80
PL-008-AW-NW-03	4000K	880	>80
PL-008-AW-WW-03	3000K	830	>80
PL-008-AW-W-04	5000K	800	>80
PL-008-AW-NW-04	4000K	780	>80
PL-008-AW-WW-04	3000K	735	>80
PL-010-AW-W-03	5000K	1190	>80
PL-010-AW-NW-03	4000K	1180	>80
PL-010-AW-WW-03	3000K	1100	>80
PL-010-AW-W-04	5000K	1055	>80
PL-010-AW-NW-04	4000K	1050	>80
PL-010-AW-WW-04	3000K	975	>80

## Size:(mm) 130LM/W Series

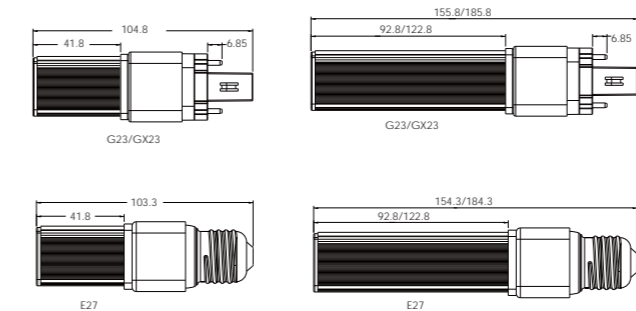

Model number	CCT	Light output (±10%/lm)	CRI
PL-003-AW-W-01H	5000K	400	>80
PL-003-AW-NW-01H	4000K	412	>80
PL-003-AW-WW-01H	3000K	380	>80
PL-003-AW-W-01HF	5000K	330	>80
PL-003-AW-NW-01HF	4000K	340	>80
PL-003-AW-WW-01HF	3000K	310	>80
PL-007-AW-W-01H	5000K	996	>80
PL-007-AW-NW-01H	4000K	1025	>80
PL-007-AW-WW-01H	3000K	926	>80
PL-007-AW-W-01HF	5000K	830	>80
PL-007-AW-NW-01HF	4000K	850	>80
PL-007-AW-WW-01HF	3000K	760	>80
PL-008-AW-W-02H	5000K	1030	>80
PL-008-AW-NW-02H	4000K	1055	>80
PL-008-AW-WW-02H	3000K	980	>80
PL-008-AW-W-02HF	5000K	860	>80
PL-008-AW-NW-02HF	4000K	880	>80
PL-008-AW-WW-02HF	3000K	800	>80
PL-010-AW-W-02H	5000K	1293	>80
PL-010-AW-NW-02H	4000K	1286	>80
PL-010-AW-WW-02H	3000K	1190	>80
PL-010-AW-W-02HF	5000K	1100	>80
PL-010-AW-NW-02HF	4000K	1095	>80
PL-010-AW-WW-02HF	3000K	990	>80
PL-011-AW-W-01H	5000K	1440	>80
PL-011-AW-NW-01H	4000K	1510	>80
PL-011-AW-WW-01H	3000K	1342	>80
PL-011-AW-W-01HF	5000K	1220	>80
PL-011-AW-NW-01HF	4000K	1260	>80
PL-011-AW-WW-01HF	3000K	1135	>80

# 360 degree PL Lamp 135LM/W



Special compact design for replacement of PL-C 18W, 28W CFL which bring us over 60% energy saving

high light efficiency, low power consumption (white LED is only 1/10 of incandescent light and 1/4 of energy-saving light).



Size:(mm) 8W

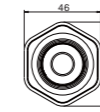
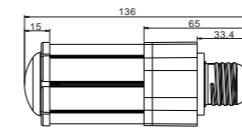

Model number	CCT	Light output (±10%)lm	CRI
PLH-008-AW-WW-01H	3000K	980	>80
PLH-008-AW-NW-01H	4000K	1030	>80
PLH-008-AW-W-01H	5000K	1100	>80
PLH-008-AW-WW-01HF	3000K	900	>80
PLH-008-AW-NW-01HF	4000K	920	>80
PLH-008-AW-W-01HF	5000K	1000	>80

Size:(mm) 12W

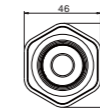
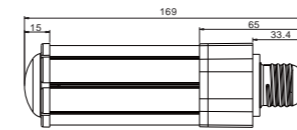

Model number	CCT	Light output (±10%)lm	CRI
PLH-012-AW-WW-01H	3000K	1500	>80
PLH-012-AW-NW-01H	4000K	1600	>80
PLH-012-AW-W-01H	5000K	1600	>80
PLH-012-AW-WW-01HF	3000K	1330	>80
PLH-012-AW-NW-01HF	4000K	1450	>80
PLH-012-AW-W-01HF	5000K	1450	>80



# Table Light



- MIX Desk Lamp ..... 247-248
- Helen Desk Lamp ..... 249-250
- C00 Desk Lamp ..... 251-252
- Helen Music Desk Lamp ..... 253-254

# MIX Desk Lamp



## TL-MIX-012-AW-BK/WT

- Two intersected cube frames form the main body of lamp.
- The interlaced linear light sources in space have a strict order and bring a comfortable lighting experience.
- Meanwhile, this desk lamp has a strong sense of sculpture, which makes it an intriguing artwork and ornament.
- This design perfectly combines functional lighting and ambience lighting.



Size:(mm)

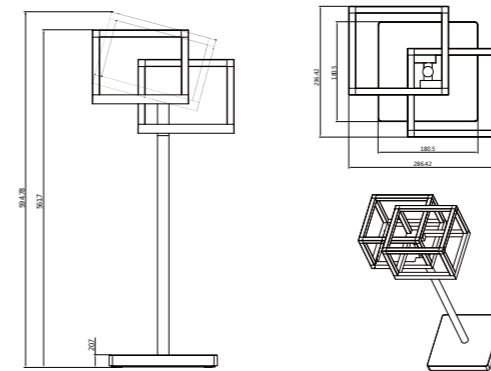

### Technical parameters:

Input voltage: AC100-240V

Output voltage: DC12V, 1A, constant voltage

CCT: 4000K

LED type (QTY): 3014 SMD (432PCS)

Control type: Touch

Lamp body material: plastic, steel

Lamp body color: black / white

Storage environment: Temperature -20-75 °; Humidity 10% - 90%

Working environment: Temperature -10-55 °; Humidity 10% - 80%

# Helen Desk Lamp



## TL-Helen-007-AW-BK/WT

- Bionic design, graceful vine-like hose freely grows;
- Lamp's shape can be adjusted according to user's preference.
- Carved leaf veins on the luminous plates just like two vivid leaves, One side of the leaves is the main light used for functional lighting,
- While the other side is used as auxiliary lighting; this design perfectly satisfies the demands for functional lighting and ambient lighting.



Size:(mm)

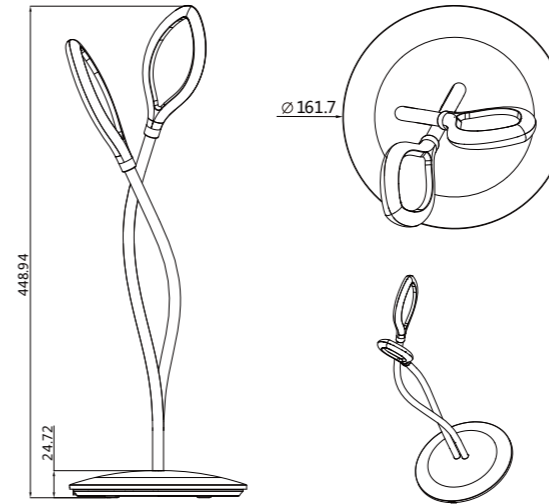

### Technical parameters:

Input voltage: AC100-240V

Output voltage: DC5V, 1.5A, constant voltage

CCT: 3000-6000K

LED Type (QTY): 3014 SMD (96PCS)

Control type: Touch

Lamp body material: plastic, steel

Lamp body color: black / white

Storage environment: Temperature -20-75 °; Humidity 10% - 90%

Working environment: Temperature -10-55° ; Humidity 10% - 80%



# COO Desk Lamp



## TL-COO-012-AW-BK/WT

- Behind the unprecedented space-intersected double-loop shape and bold innovation is the overall functional consideration.
- The intersection of two loops is an ingenious rotation shaft design to provide a variety of lighting applications.
- User can easily switch the lamp among read, ambient lighting and other modes.
- The use of minimalism and geometry and the shaft design at the intersection of two loops make this lamp have the
- industrial design style and charms without losing the functional flexibility.



Size:(mm)

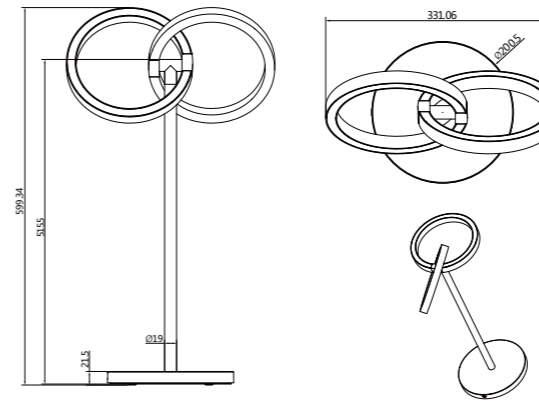

### Technical parameters:

Input voltage: AC100-240V

Output voltage:DC12V,1A,constant voltage

CCT: 4000K

LED Type (Quantity):3014 SMD(164PCS)

Control type: Touch

Lamp body material: plastic, steel

Lamp body color: black / white

Storage environment: Temperature -20-75° Humidity 10%-90%

Working environment:Temperature-10-55° Humidity 10%-80%

# Helen Music Desk Lamp

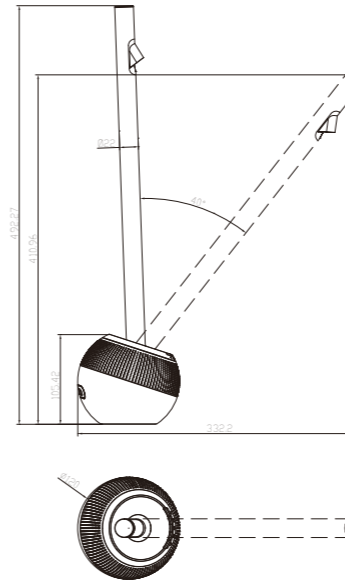

Size:(mm)

**Technical parameters:**

Input voltage: AC100-240V

Output voltage: DC5V,1.5A,constant voltage

Power: 7.5W

CCT: 2300-6500K

LED Type (Quantity):3030SMD(4PCS)

Control type: Touch

Lamp body material: plastic, steel

Lamp body color: black / white

Storage environment: Temperature -20-75° Humidity 10%-90%

Working environment:Temperature-10-55° Humidity 10%-80%

## TL-Bob-007-AW-BK/WT

- Main function: Bluetooth sound box, APP control, AUX input, rotatable lamp head, FM, dimming, color mixing, built-in battery.
- The extreme exquisite shape explains the modern simplest aesthetics.
- The upright rod can rotate freely to remove dead angle of lighting.
- The spherical base is round and stable to provide sonorous sound.
- The perfect combination of light and sound brings extremely carefree use experience.





# Industrial Lighting

How to find safe and durable LED lamps from a variety of industry lights on the market?

Signcomplex offer various led luminaries for any industrial or hazardous application, like led tri-proof lighting, high-bay, low-bay lightings, led flood light, canopy lighting. We optimize the benefits of led technology to offer the innovative and reliable led luminaire on the market.

Signcomplex's industrial lighting provide higher lumens as compared with traditional lighting. Adopt well-known LEDs source, CREE, BRIDGELUX, SEOUL SAMSUNG, light efficiency up to 110LM/W, average consume 50% less energy than HID, 40% less energy than MH luminares. This is a significant upgrade over traditional light sources, and expected operating life of industrial lighting is 50000 hours.

Our industry lamp adopt professional surface treatment, spraying powder, anodized oxidation, hard anodizing, so our products can be used indoor and various harsh outdoor environment. As LED lighting leader, we produce all kinds of waterproof lamps, including IP68, IP67, IP66, IP65, to meet commercial and industry lighting.

Signcomplex's industrial lighting is specifically engineered to remove heat from the led and driver to ensure longer lifetime, better lumen output.

Application: widely used in factory, farm, airport, warehouse, supermarket, parking lot, station and other places.



# High bay & Low bay lighting series



- High Bay Light Cibay Series ..... 261-264
- Linear High Bay Light Series ..... 265-268
- LiBay High Bay & Low Bay Lighting Series ..... 269-272

# High Bay Light CibayII-P Series



Aluminum profile+toughened glass,  
high impact-resistance

LEDs are circularly arranged in symmetric,  
heat source are efficiently distributed in balance

Adopt waterproof structure design,  
waterproof level up to IP65;



0-10 Dimmers

Microwave sensing

Assemble the U-bracket



Size:(mm/inch) 60W

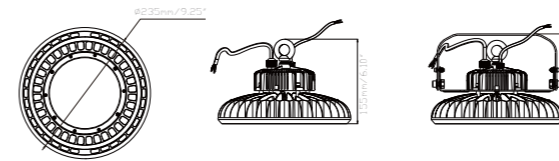

Size:(mm/inch) 100W

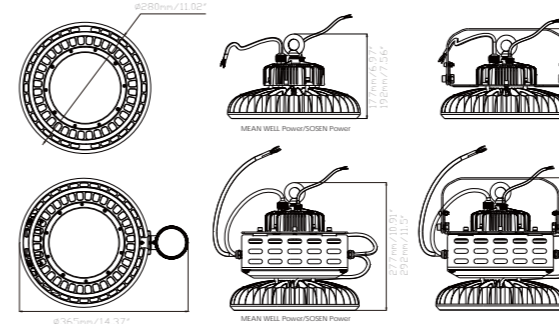

Size:(mm/inch) 150W

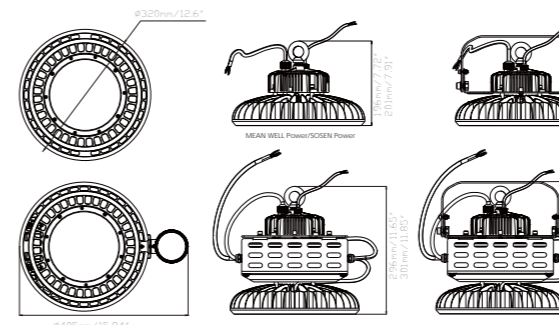

Size:(mm/inch) 200W

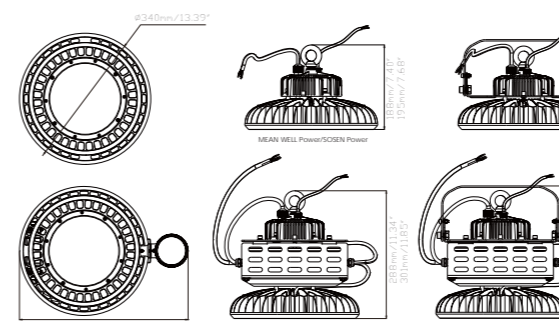

Size:(mm/inch) 240W

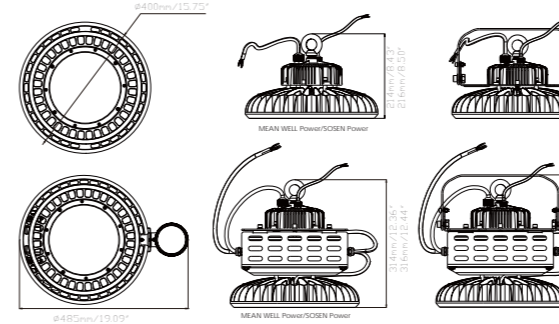

\* Two optional power supplies vary in height

Model number	CCT	Light output (±10%)lm	CRI
CB2-060-AW-W	5000K	8290	>80
CB2-060-AW-NW	4000K	8120	>80
CB2-060-AW-WW	3000K	7560	>80

Model number	CCT	Light output (±10%)lm	CRI
CB2-100-AW-W	5000K	14020	>80
CB2-100-AW-NW	4000K	13550	>80
CB2-100-AW-WW	3000K	12610	>80

Model number	CCT	Light output (±10%)lm	CRI
CB2-150-AW-W	5000K	20960	>80
CB2-150-AW-NW	4000K	20270	>80
CB2-150-AW-WW	3000K	18920	>80

Model number	CCT	Light output (±10%)lm	CRI
CB2-200-AW-W	5000K	27840	>80
CB2-200-AW-NW	4000K	26930	>80
CB2-200-AW-WW	3000K	24920	>80

Model number	CCT	Light output (±10%)lm	CRI
CB2-240-AW-W	5000K	33990	>80
CB2-240-AW-NW	4000K	32660	>80
CB2-240-AW-WW	3000K	30490	>80

# High Bay Light Cibay-A Series

The heat sink adopt 1060 high-purity aluminum, stamp forming;and the thermal conductivity exceed 200W/M.K

High lighting effect LEDs up to 135lm/w  
Multiple beam angles optional:60°, 90°, 120°

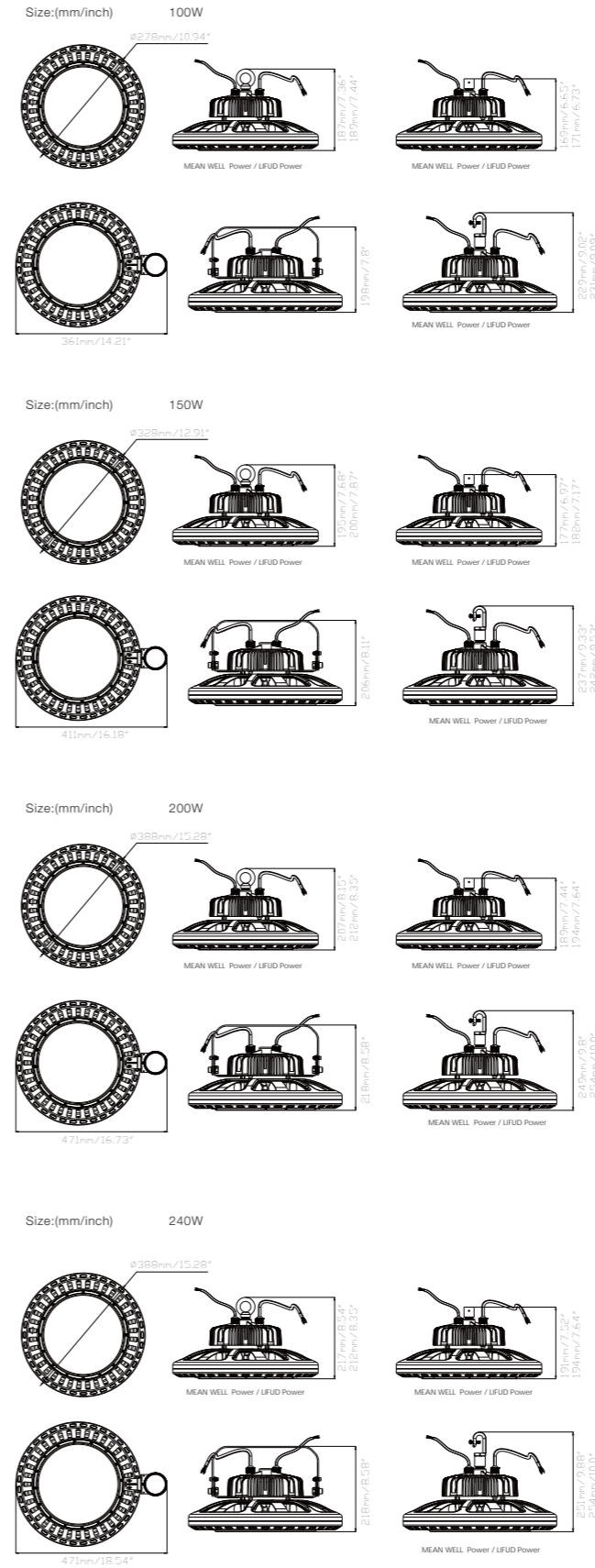

Model number	CCT	Light output (±10%)lm	CRI
CB-100-AW-50K	5000K	13500	>80
CB-100-AW-40K	4000K	13200	>80
CB-100-AW-30K	3000K	12200	>80

Model number	CCT	Light output (±10%)lm	CRI
CB-150-AW-50K	5000K	20550	>80
CB-150-AW-40K	4000K	20100	>80
CB-150-AW-30K	3000K	18600	>80

Model number	CCT	Light output (±10%)lm	CRI
CB-200-AW-50K	5000K	27000	>80
CB-200-AW-40K	4000K	26400	>80
CB-200-AW-30K	3000K	24400	>80

Model number	CCT	Light output (±10%)lm	CRI
CB-240-AW-50K	5000K	32640	>80
CB-240-AW-40K	4000K	31920	>80
CB-240-AW-30K	3000K	29520	>80

# Linear High Bay Light



suspension installation

Modular design, low glare  
Lighting effect 130lm/w, 150lm/w  
can save 60% energy



Pole mounting



Microwave sensing



Size:(mm/inch) 60W

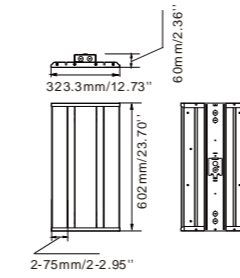

Size:(mm/inch) 100W

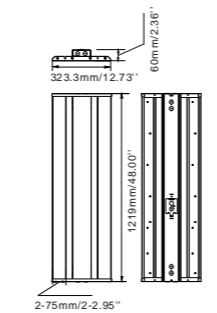
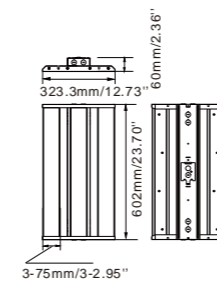

Size:(mm/inch) 120W

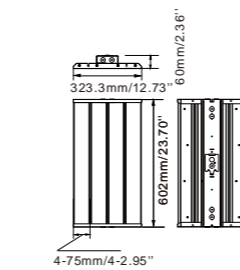

Model number	CCT	Light output (±10%)lm	CRI
LH2F-060-AW-50K-01	5000K	8280	>80
LH2F-060-AW-40K-01	4000K	8100	>80
LH2F-060-AW-35K-01	3500K	7800	>80
LH2F-060-AW-30K-01	3000K	7800	>80
LH2F-060-AW-50K-02	5000K	7920	>80
LH2F-060-AW-40K-02	4000K	7800	>80
LH2F-060-AW-35K-02	3500K	7620	>80
LH2F-060-AW-30K-02	3000K	7620	>80
LH2F-060-AW-50K-13	5000K	9000	>80
LH2F-060-AW-40K-13	4000K	8760	>80
LH2F-060-AW-35K-13	3500K	8640	>80
LH2F-060-AW-30K-13	3000K	8640	>80

Model number	CCT	Light output (±10%)lm	CRI
LH2F-100-AW-50K-01	5000K	13800	>80
LH2F-100-AW-40K-01	4000K	13500	>80
LH2F-100-AW-35K-01	3500K	13000	>80
LH2F-100-AW-30K-01	3000K	13000	>80
LH2F-100-AW-50K-02	5000K	13200	>80
LH2F-100-AW-40K-02	4000K	13000	>80
LH2F-100-AW-35K-02	3500K	12700	>80
LH2F-100-AW-30K-02	3000K	12700	>80
LH2F-100-AW-50K-13	5000K	15000	>80
LH2F-100-AW-40K-13	4000K	14600	>80
LH2F-100-AW-35K-13	3500K	14400	>80
LH2F-100-AW-30K-13	3000K	14400	>80

Model number	CCT	Light output (±10%)lm	CRI
LH4F-100-AW-50K-01	5000K	13800	>80
LH4F-100-AW-40K-01	4000K	13500	>80
LH4F-100-AW-35K-01	3500K	13000	>80
LH4F-100-AW-30K-01	3000K	13000	>80
LH4F-100-AW-50K-02	5000K	13200	>80
LH4F-100-AW-40K-02	4000K	13000	>80
LH4F-100-AW-35K-02	3500K	12700	>80
LH4F-100-AW-30K-02	3000K	12700	>80
LH4F-100-AW-50K-13	5000K	15000	>80
LH4F-100-AW-40K-13	4000K	14600	>80
LH4F-100-AW-35K-13	3500K	14400	>80
LH4F-100-AW-30K-13	3000K	14400	>80

Model number	CCT	Light output (±10%)lm	CRI
LH2F-120-AW-50K-01	5000K	16560	>80
LH2F-120-AW-40K-01	4000K	16200	>80
LH2F-120-AW-35K-01	3500K	15600	>80
LH2F-120-AW-30K-01	3000K	15600	>80
LH2F-120-AW-50K-02	5000K	15840	>80
LH2F-120-AW-40K-02	4000K	15600	>80
LH2F-120-AW-35K-02	3500K	15240	>80
LH2F-120-AW-30K-02	3000K	15240	>80
LH2F-120-AW-50K-13	5000K	18000	>80
LH2F-120-AW-40K-13	4000K	17520	>80
LH2F-120-AW-35K-13	3500K	17280	>80
LH2F-120-AW-30K-13	3000K	17280	>80



Size:(mm/inch) 150W

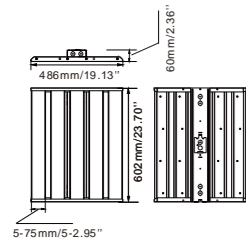

Model number	CCT	Light output (±10%)lm	CRI
LH4F-150-AW-50K-01	5000K	20700	>80
LH4F-150-AW-40K-01	4000K	20250	>80
LH4F-150-AW-35K-01	3500K	19500	>80
LH4F-150-AW-30K-01	3000K	19500	>80
LH4F-150-AW-50K-02	5000K	19800	>80
LH4F-150-AW-40K-02	4000K	19500	>80
LH4F-150-AW-35K-02	3500K	19050	>80
LH4F-150-AW-30K-02	3000K	19050	>80
LH4F-150-AW-50K-13	5000K	22500	>80
LH4F-150-AW-40K-13	4000K	21900	>80
LH4F-150-AW-35K-13	3500K	21600	>80
LH4F-150-AW-30K-13	3000K	21600	>80

Size:(mm/inch) 250W

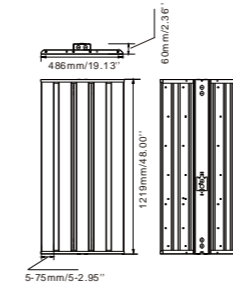

Model number	CCT	Light output (±10%)lm	CRI
LH4F-250-AW-50K-01	5000K	34500	>80
LH4F-250-AW-40K-01	4000K	33750	>80
LH4F-250-AW-35K-01	3500K	32500	>80
LH4F-250-AW-30K-01	3000K	32500	>80
LH4F-250-AW-50K-02	5000K	33000	>80
LH4F-250-AW-40K-02	4000K	32500	>80
LH4F-250-AW-35K-02	3500K	31750	>80
LH4F-250-AW-30K-02	3000K	31750	>80
LH4F-250-AW-50K-13	5000K	37500	>80
LH4F-250-AW-40K-13	4000K	36500	>80
LH4F-250-AW-35K-13	3500K	36000	>80
LH4F-250-AW-30K-13	3000K	36000	>80

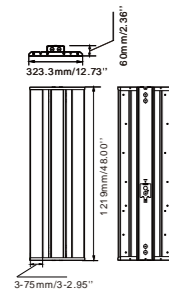

Model number	CCT	Light output (±10%)lm	CRI
LH2F-150-AW-50K-01	5000K	20700	>80
LH2F-150-AW-40K-01	4000K	20250	>80
LH2F-150-AW-35K-01	3500K	19500	>80
LH2F-150-AW-30K-01	3000K	19500	>80
LH2F-150-AW-50K-02	5000K	19800	>80
LH2F-150-AW-40K-02	4000K	19500	>80
LH2F-150-AW-35K-02	3500K	19050	>80
LH2F-150-AW-30K-02	3000K	19050	>80
LH2F-150-AW-50K-13	5000K	22500	>80
LH2F-150-AW-40K-13	4000K	21900	>80
LH2F-150-AW-35K-13	3500K	21600	>80
LH2F-150-AW-30K-13	3000K	21600	>80

Size:(mm/inch) 300W

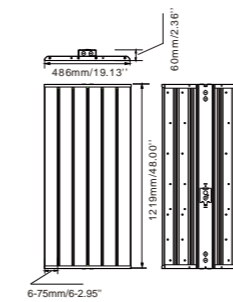

Model number	CCT	Light output (±10%)lm	CRI
LH4F-300-AW-50K-01	5000K	41400	>80
LH4F-300-AW-40K-01	4000K	40500	>80
LH4F-300-AW-35K-01	3500K	39000	>80
LH4F-300-AW-30K-01	3000K	39000	>80
LH4F-300-AW-50K-02	5000K	39600	>80
LH4F-300-AW-40K-02	4000K	39000	>80
LH4F-300-AW-35K-02	3500K	38100	>80
LH4F-300-AW-30K-02	3000K	38100	>80
LH4F-300-AW-50K-13	5000K	45000	>80
LH4F-300-AW-40K-13	4000K	43800	>80
LH4F-300-AW-35K-13	3500K	43200	>80
LH4F-300-AW-30K-13	3000K	43200	>80

\*2F=2FEET 4F=4FEET 01=clear cover 02=milky cover  
13=frosted mask High brightness style

Size:(mm/inch) 180W

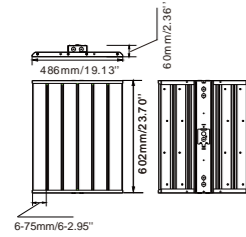

Model number	CCT	Light output (±10%)lm	CRI
LH2F-180-AW-50K-01	5000K	24840	>80
LH2F-180-AW-40K-01	4000K	24300	>80
LH2F-180-AW-35K-01	3500K	23400	>80
LH2F-180-AW-30K-01	3000K	23400	>80
LH2F-180-AW-50K-02	5000K	23760	>80
LH2F-180-AW-40K-02	4000K	23400	>80
LH2F-180-AW-35K-02	3500K	22860	>80
LH2F-180-AW-30K-02	3000K	22860	>80
LH2F-180-AW-50K-13	5000K	27000	>80
LH2F-180-AW-40K-13	4000K	26280	>80
LH2F-180-AW-35K-13	3500K	25920	>80
LH2F-180-AW-30K-13	3000K	25920	>80

Size:(mm/inch) 200W

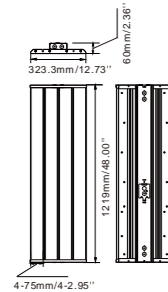

Model number	CCT	Light output (±10%)lm	CRI
LH4F-200-AW-50K-01	5000K	27600	>80
LH4F-200-AW-40K-01	4000K	27000	>80
LH4F-200-AW-35K-01	3500K	26000	>80
LH4F-200-AW-30K-01	3000K	26000	>80
LH4F-200-AW-50K-02	5000K	26400	>80
LH4F-200-AW-40K-02	4000K	26000	>80
LH4F-200-AW-35K-02	3500K	25400	>80
LH4F-200-AW-30K-02	3000K	25400	>80
LH4F-200-AW-50K-02	5000K	30000	>80
LH4F-200-AW-40K-13	4000K	29200	>80
LH4F-200-AW-35K-13	3500K	28800	>80
LH4F-200-AW-30K-13	3000K	28800	>80

# LiBay High Bay & Low Bay Lighting Series

Seoul LED Type

Up to 50% more energy efficient than fluorescent light,  
and 50% more energy efficiency than HID luminaries



Size:(mm/inch) 90W

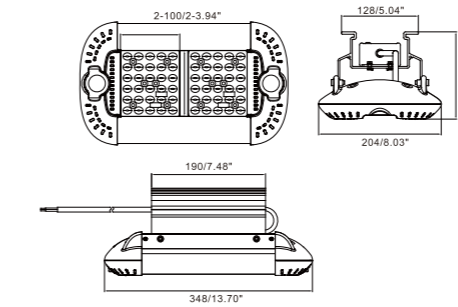

Size:(mm/inch) 120W

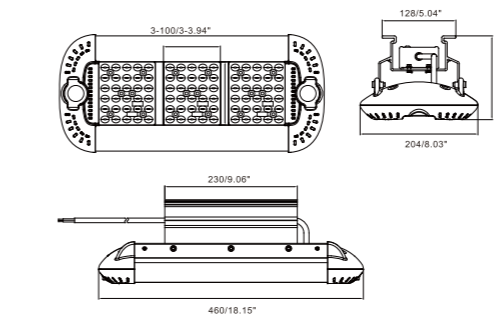

Size:(mm/inch) 150W

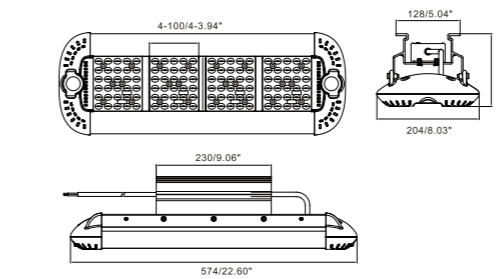

Size:(mm/inch) 200W

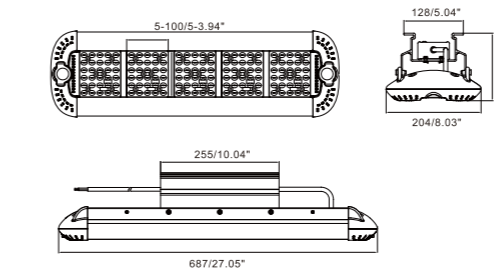

Model number	CCT	Light output (±10%)lm	CRI
GK-090-AW-W-L-04/05	5500-6500K	11530	>70
GK-090-AW-NW-L-04/05	4000-4500K	10930	>70
GK-090-AW-WW-L-04/05	2700-3200K	10340	>70
GK-090-AW-W-L-16/19	5500-6500K	9730	>70
GK-090-AW-NW-L-16/19	4000-4500K	9300	>70
GK-090-AW-WW-L-16/19	2700-3200K	8560	>70
GK-090-AW-W-L-17/20	5500-6500K	10670	>70
GK-090-AW-NW-L-17/20	4000-4500K	10190	>70
GK-090-AW-WW-L-17/20	2700-3200K	9340	>70
GK-090-AW-W-L-18/21	5500-6500K	10810	>70
GK-090-AW-NW-L-18/21	4000-4500K	10330	>70
GK-090-AW-WW-L-18/21	2700-3200K	9590	>70

Model number	CCT	Light output (±10%)lm	CRI
GK-120-AW-W-L-04/05	5500-6500K	14930	>70
GK-120-AW-NW-L-04/05	4000-4500K	14730	>70
GK-120-AW-WW-L-04/05	2700-3200K	14030	>70
GK-120-AW-W-L-16/19	5500-6500K	13400	>70
GK-120-AW-NW-L-16/19	4000-4500K	12800	>70
GK-120-AW-WW-L-16/19	2700-3200K	11470	>70
GK-120-AW-W-L-17/20	5500-6500K	14130	>70
GK-120-AW-NW-L-17/20	4000-4500K	13500	>70
GK-120-AW-WW-L-17/20	2700-3200K	12330	>70
GK-120-AW-W-L-18/21	5500-6500K	14410	>70
GK-120-AW-NW-L-18/21	4000-4500K	13770	>70
GK-120-AW-WW-L-18/21	2700-3200K	12630	>70

Model number	CCT	Light output (±10%)lm	CRI
GK-150-AW-W-L-04/05	5500-6500K	19580	>70
GK-150-AW-NW-L-04/05	4000-4500K	19640	>70
GK-150-AW-WW-L-04/05	2700-3200K	18740	>70
GK-150-AW-W-L-16/19	5500-6500K	16960	>70
GK-150-AW-NW-L-16/19	4000-4500K	16210	>70
GK-150-AW-WW-L-16/19	2700-3200K	14850	>70
GK-150-AW-W-L-17/20	5500-6500K	17740	>70
GK-150-AW-NW-L-17/20	4000-4500K	16940	>70
GK-150-AW-WW-L-17/20	2700-3200K	15510	>70
GK-150-AW-W-L-18/21	5500-6500K	18570	>70
GK-150-AW-NW-L-18/21	4000-4500K	17740	>70
GK-150-AW-WW-L-18/21	2700-3200K	15840	>70

Model number	CCT	Light output (±10%)lm	CRI
GK-200-AW-W-L-04/05	5500-6500K	24770	>70
GK-200-AW-NW-L-04/05	4000-4500K	25080	>70
GK-200-AW-WW-L-04/05	2700-3200K	24110	>70
GK-200-AW-W-L-16/19	5500-6500K	23230	>70
GK-200-AW-NW-L-16/19	4000-4500K	22190	>70
GK-200-AW-WW-L-16/19	2700-3200K	19930	>70
GK-200-AW-W-L-17/20	5500-6500K	23780	>70
GK-200-AW-NW-L-17/20	4000-4500K	22680	>70
GK-200-AW-WW-L-17/20	2700-3200K	20790	>70
GK-200-AW-W-L-18/21	5500-6500K	24160	>70
GK-200-AW-NW-L-18/21	4000-4500K	23080	>70
GK-200-AW-WW-L-18/21	2700-3200K	20310	>70

# LiBay High Bay & Low Bay Lighting Series

2835 LED Type

Up to 50% more energy efficient than fluorescent light, and 50% more energy efficiency than HID luminaries



Size:(mm/inch) 90W

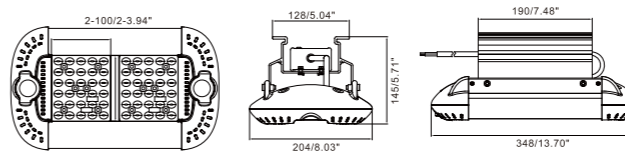

Size:(mm/inch) 120W

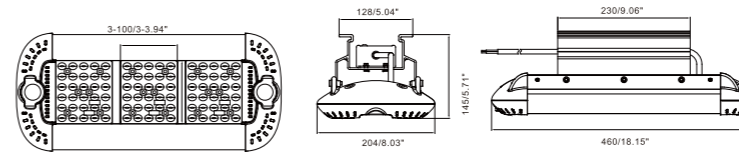

Size:(mm/inch) 150W

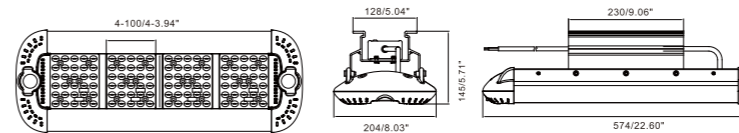

Size:(mm/inch) 200W

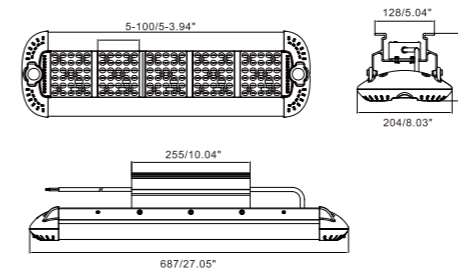

Size:(mm/inch) 240W

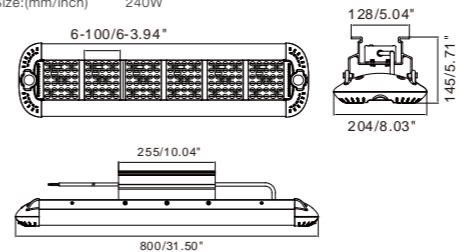

Size:(mm/inch) 280W

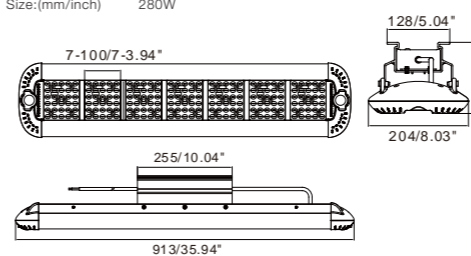

Model number	CCT	Light output (±10%)lm	CRI
GK-090-AW-W-L-28	5500-6500K	10270	>80
GK-090-AW-NW-L-28	3800-4200K	9780	>80
GK-090-AW-WW-L-28	2700-3200K	9340	>80

Model number	CCT	Light output (±10%)lm	CRI
GK-120-AW-W-L-28	5500-6500K	13340	>80
GK-120-AW-NW-L-28	3800-4200K	12710	>80
GK-120-AW-WW-L-28	2700-3200K	11550	>80

Model number	CCT	Light output (±10%)lm	CRI
GK-150-AW-W-L-28	5500-6500K	16640	>80
GK-150-AW-NW-L-28	3800-4200K	15840	>80
GK-150-AW-WW-L-28	2700-3200K	14400	>80

Model number	CCT	Light output (±10%)lm	CRI
GK-200-AW-W-L-28	5500-6500K	24070	>80
GK-200-AW-NW-L-28	3800-4200K	22920	>80
GK-200-AW-WW-L-28	2700-3200K	20840	>80

Model number	CCT	Light output (±10%)lm	CRI
GK-240-AW-W-L-28	5500-6500K	29420	>80
GK-240-AW-NW-L-28	3800-4200K	28020	>80
GK-240-AW-WW-L-28	2700-3200K	25470	>80

Model number	CCT	Light output (±10%)lm	CRI
GK-280-AW-W-L-28	5500-6500K	35340	>80
GK-280-AW-NW-L-28	3800-4200K	33700	>80
GK-280-AW-WW-L-28	2700-3200K	30640	>80

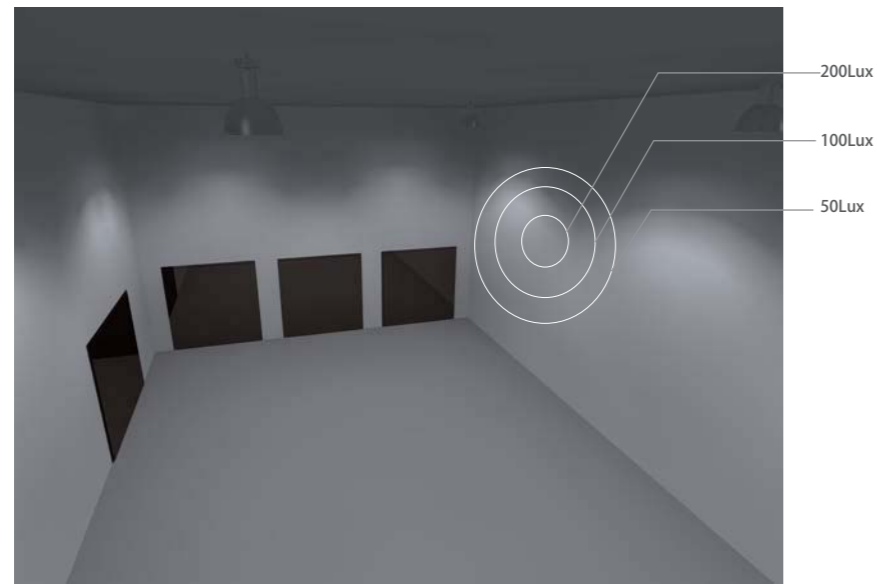

Industrial Area / Storage Building / Ground Floor / Storage / Workplane 5 / Isolines/Perpendicular illuminance (adaptive)  
**Workplane 5 / Isolines/Perpendicular illuminance (adaptive)**

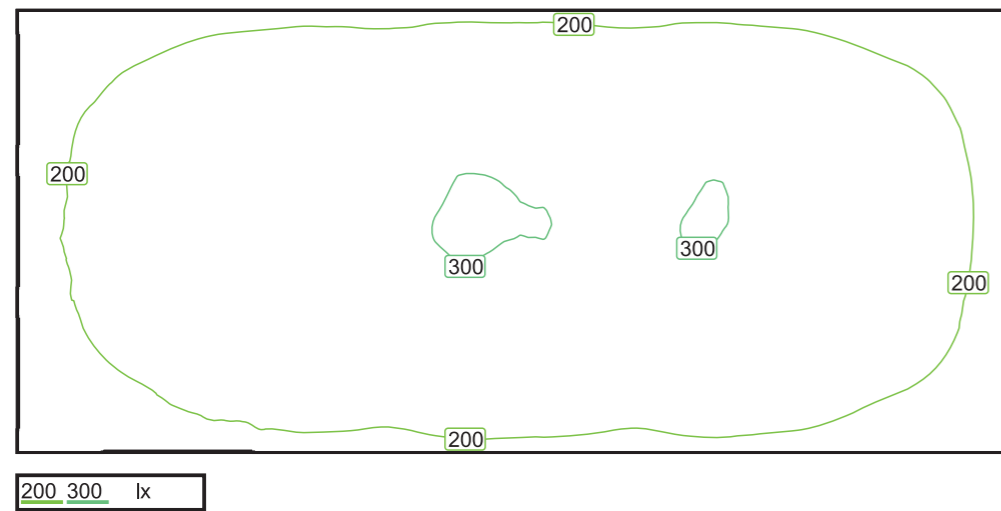

Scale: 1 : 200

Perpendicular illuminance (Surface)  
 Average: 240 lx, Min: 113 lx, Max: 303 lx, Min/average: 0.469, Min/max: 0.371, Points: 1024 x 512 (Relevant: 523586)

Height of working plane: 0.800 m, Wall zone: 0.000 m

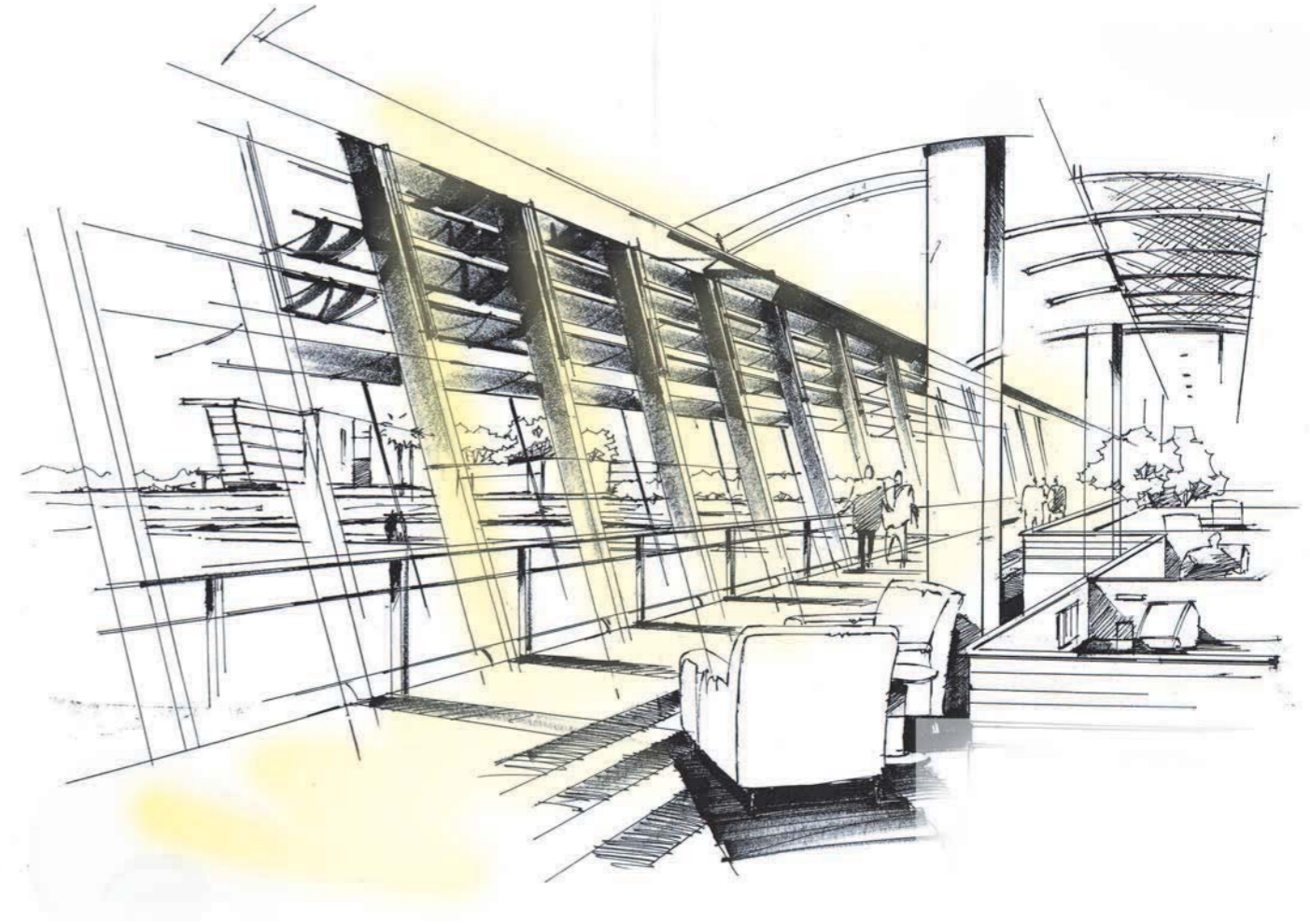

### High Bay Light

- . CREE or Epistar or Bridgelux LEDs, light efficiency of lamp up to 100lm/W
- . MEANWELL power supply, efficiency>90%
- . Patent thermal management, lamp body temperature<45°C
- . Glass lens, can endure high temperature of 300°C and light transmittance up to 90%
- . High quality LEDs, stable power supply, patent thermal management technology  
 make sure light decay<10% after 25,000 hours

# Flood Light



- Landy Series Flood Light ..... 277-278
- PW Projector Light ..... 279-280
- Ultra-slim PIR Flood Light ..... 281-282
- Landy Series PIR Flood Light ..... 283-284

# Landy Series Flood Light



Size:(mm) 10W

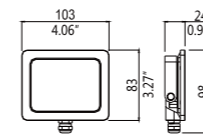

Size:(mm) 20W / 30W

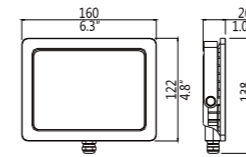

Size:(mm) 50W

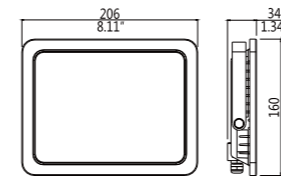

Size:(mm) 100W

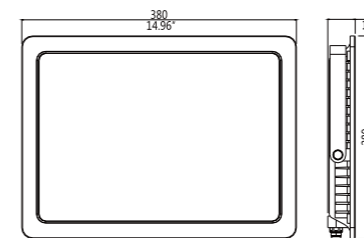

Size:(mm) 150W

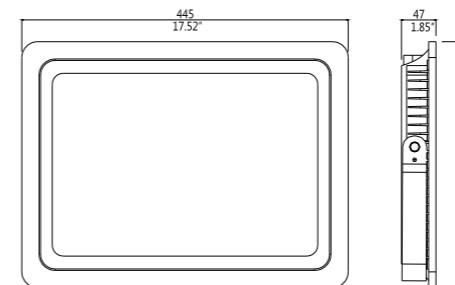

Model number	CCT	Light output (±10%/lm)	CRI
FL-010-AH-W-L01	5500-6500K	850	>80
FL-010-AH-NW-L01	3800-4200K	840	>80
FL-010-AH-WW-L01	2700-3200K	800	>80

Model number	CCT	Light output (±10%/lm)	CRI
FL-020-AH-W-L01	5500-6500K	1900	>80
FL-020-AH-NW-L01	3800-4200K	1880	>80
FL-020-AH-WW-L01	2700-3200K	1600	>80

Model number	CCT	Light output (±10%/lm)	CRI
FL-030-AH-W-L01	5500-6500K	2300	>80
FL-030-AH-NW-L01	3800-4200K	2200	>80
FL-030-AH-WW-L01	2700-3200K	2000	>80

Model number	CCT	Light output (±10%/lm)	CRI
FL-050-AH-W-L01	5500-6500K	4750	>80
FL-050-AH-NW-L01	3800-4200K	4700	>80
FL-050-AH-WW-L01	2700-3200K	4000	>80

Model number	CCT	Light output (±10%/lm)	CRI
FL-100-AH-W-L01	5500-6500K	9200	>80
FL-100-AH-NW-L01	3800-4200K	9150	>80
FL-100-AH-WW-L01	2700-3200K	7900	>80

Model number	CCT	Light output (±10%/lm)	CRI
FL-150-AH-W-L01	5500-6500K	12750	>80
FL-150-AH-NW-L01	3800-4200K	12600	>80
FL-150-AH-WW-L01	2700-3200K	11700	>80

# PW Projector Light Series

Adopt Seoul high lighting effect LEDs, can be up to 130 LM/W; higher lighting effect, more energy-saving

Meanwell waterproof power supply, more reliable performance; Designed with breathing apparatus, higher water-proof performance



Employ die-casting aluminum alloy lamp body



Size:(mm) 150W

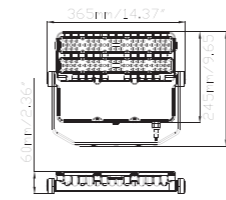

Size:(mm) 200W

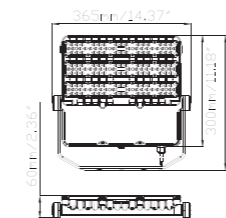

Size:(mm) 240W

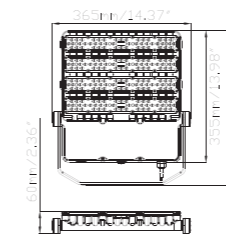

Size:(mm) 300W

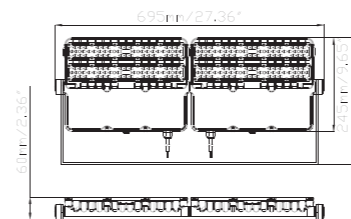

Size:(mm) 380W

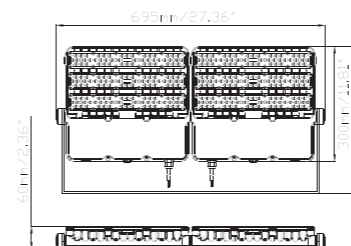

Size:(mm) 450W

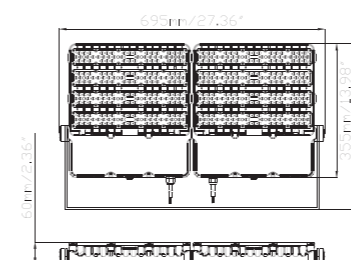

Model number	CCT	Light output (±10%)lm	CRI
PW-150-AH-W-ZZ	5500-6500K	16810/16370	>80
PW-150-AH-NW-ZZ	4000-4500K	16010/15590	>80
PW-150-AH-WW-ZZ	2700-3200K	15250/14850	>80

Model number	CCT	Light output (±10%)lm	CRI
PW-200-AH-W-ZZ	5500-6500K	23600/23580	>80
PW-200-AH-NW-ZZ	4000-4500K	22480/22460	>80
PW-200-AH-WW-ZZ	2700-3200K	21410/21390	>80

Model number	CCT	Light output (±10%)lm	CRI
PW-240-AH-W-ZZ	5500-6500K	28980/28670	>80
PW-240-AH-NW-ZZ	4000-4500K	27600/27300	>80
PW-240-AH-WW-ZZ	2700-3200K	26280/26000	>80

Model number	CCT	Light output (±10%)lm	CRI
PW-300-AH-W-ZZ	5500-6500K	34250/32840	>80
PW-300-AH-NW-ZZ	4000-4500K	32620/31270	>80
PW-300-AH-WW-ZZ	2700-3200K	31070/29780	>80

Model number	CCT	Light output (±10%)lm	CRI
PW-380-AH-W-YY	5500-6500K	46430/44930	>80
PW-380-AH-NW-YY	4000-4500K	44220/42790	>80
PW-380-AH-WW-YY	2700-3200K	42120/40750	>80

Model number	CCT	Light output (±10%)lm	CRI
PW-450-AH-W-YY	5500-6500K	55830/53270	>80
PW-450-AH-NW-YY	4000-4500K	53170/50730	>80
PW-450-AH-WW-YY	2700-3200K	50640/48310	>80

# Ultra-slim PIR Flood Light



Adopt die-casting aluminum alloy lamp body, high toughened glass cover; Strong and durable, excellent thermal management, save energy 60% compared with traditional light

Detection distance: max.12m (24 °C) (adjustable), Delay time:5 seconds-6 minutes(adjustable)



Size:(mm) 10W

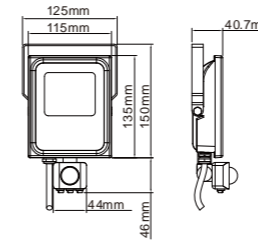

Model number	CCT	Light output (±10%)lm	CRI
FL-010-AW-W-S2-S01	5500-6500K	860	>70
FL-010-AW-NW-S2-S01	3800-4200K	830	>70
FL-010-AW-WW-S2-S01	2700-3200K	800	>70

Size:(mm) 20W

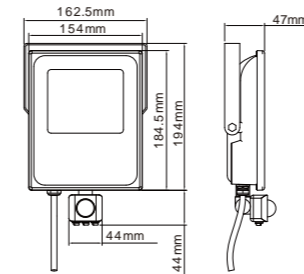

Model number	CCT	Light output (±10%)lm	CRI
FL-020-AW-W-S2-S01	5500-6500K	1850	>70
FL-020-AW-NW-S2-S01	3800-4200K	1840	>70
FL-020-AW-WW-S2-S01	2700-3200K	1800	>70

Size:(mm) 30W

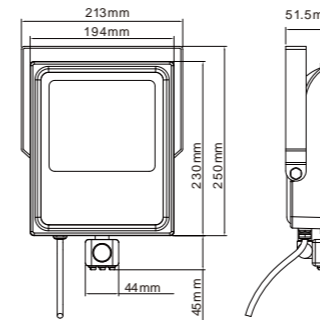

Model number	CCT	Light output (±10%)lm	CRI
FL-030-AW-W-S2-S01	5500-6500K	2780	>70
FL-030-AW-NW-S2-S01	3800-4200K	2740	>70
FL-030-AW-WW-S2-S01	2700-3200K	2710	>70

Size:(mm) 50W

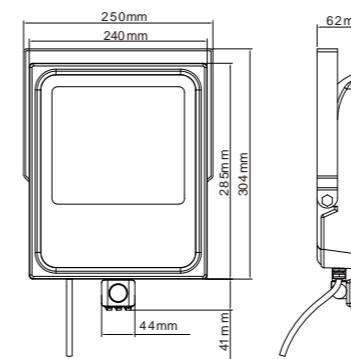

Model number	CCT	Light output (±10%)lm	CRI
FL-050-AW-W-S2-S01	5500-6500K	4650	>70
FL-050-AW-NW-S2-S01	3800-4200K	4620	>70
FL-050-AW-WW-S2-S01	2700-3200K	4550	>70





# Landy Series PIR Flood Light

The reflector with tempered glass shape is efficient and energy saving



high quality 2835 LED as light source, efficiency of fixture is up to 100LM/W

The die casting aluminum alloy lamp body features good heat dissipation, firm and durable



Size:(mm) 10W

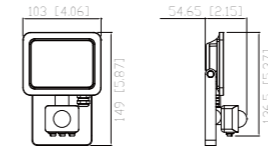

Size:(mm) 20W / 30W

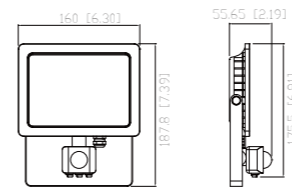

Size:(mm) 50W

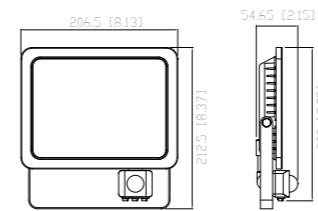

Size:(mm) 100W

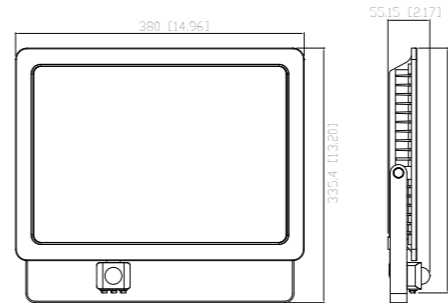

Model number	CCT	Light output (±10%)lm	CRI
FL-010-AH-W-LS02	5500-6500K	850	>80
FL-010-AH-NW-LS02	3800-4200K	840	>80
FL-010-AH-WW-LS02	2700-3200K	800	>80

Model number	CCT	Light output (±10%)lm	CRI
FL-020-AH-W-LS02	5500-6500K	1900	>80
FL-020-AH-NW-LS02	3800-4200K	1880	>80
FL-020-AH-WW-LS02	2700-3200K	1600	>80

Model number	CCT	Light output (±10%)lm	CRI
FL-030-AH-W-LS02	5500-6500K	2300	>80
FL-030-AH-NW-LS02	3800-4200K	2200	>80
FL-030-AH-WW-LS02	2700-3200K	2000	>80

Model number	CCT	Light output (±10%)lm	CRI
FL-050-AH-W-LS02	5500-6500K	4750	>80
FL-050-AH-NW-LS02	3800-4200K	4700	>80
FL-050-AH-WW-LS02	2700-3200K	4000	>80

Model number	CCT	Light output (±10%)lm	CRI
FL-100-AH-W-LS02	5500-6500K	9200	>80
FL-100-AH-NW-LS02	3800-4200K	9150	>80
FL-100-AH-WW-LS02	2700-3200K	7900	>80



Industrial Area / Calculation surface 4 / Isolines/Horizontal illuminance

Calculation surface 4 / Isolines/Horizontal illuminance

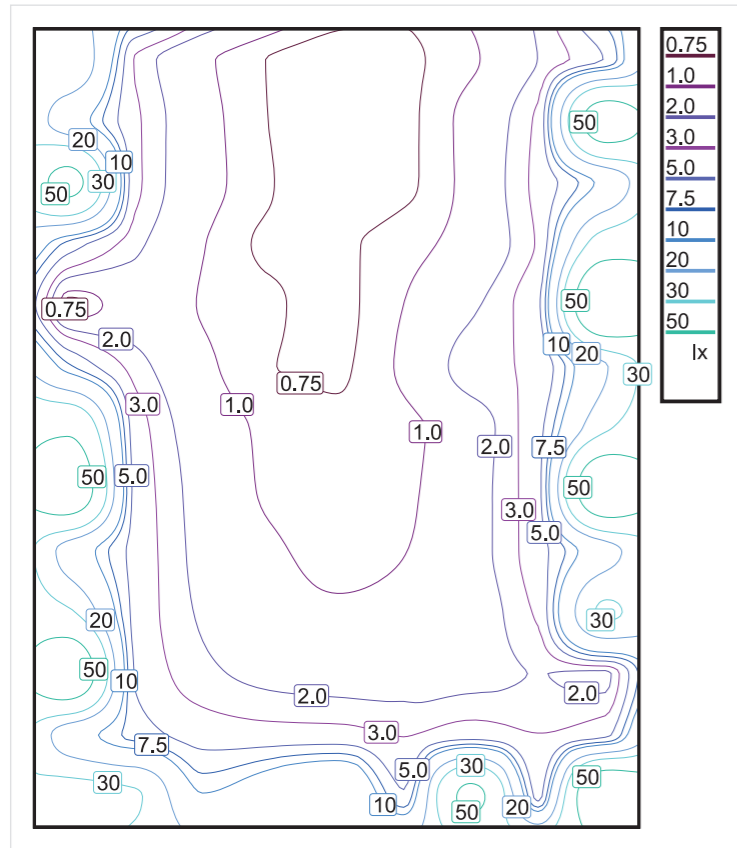

Horizontal illuminance (Grid)

Average: 9.95 lx, Min: 0.62 lx, Max: 83 lx, Min/average: 0.062, Min/max: 0.007, Points: 9 x 13 (Relevant: all)



Scale: 1 : 200

Industrial Area / Calculation surface 6 / Value chart/Horizontal illuminance

Calculation surface 6 / Value chart/Horizontal illuminance

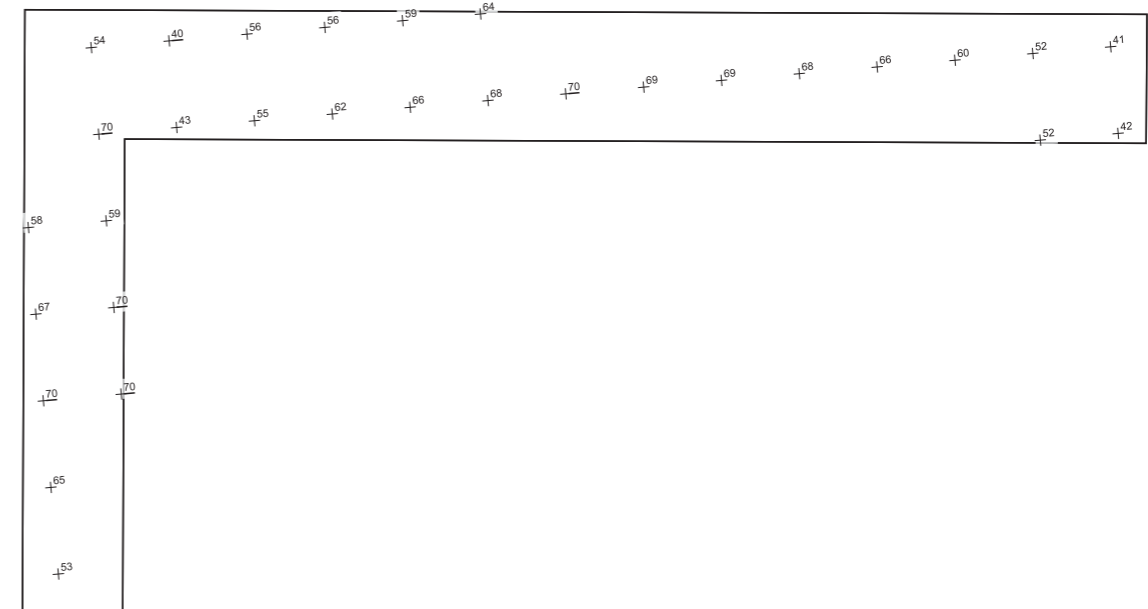

Scale: 1 : 100

Horizontal illuminance (Grid)

Average: 60 lx, Min: 40 lx, Max: 70 lx, Min/average: 0.667, Min/max: 0.571, Points: 15 x 7 (Relevant: 30)

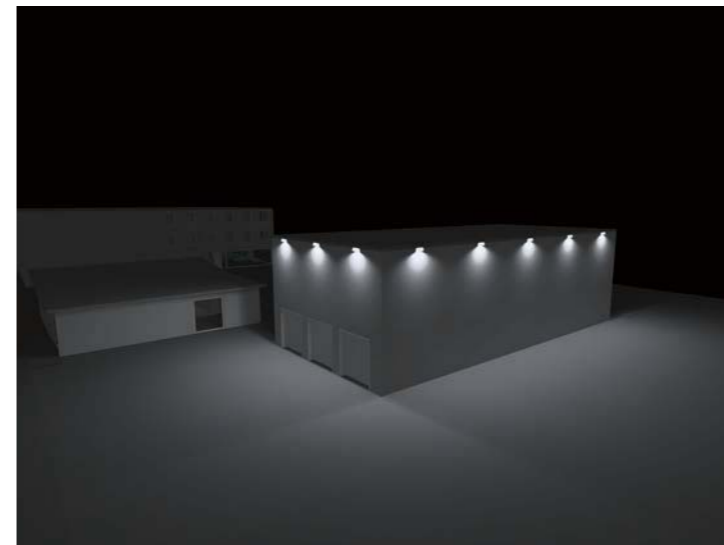

# Tri-proof Lamp



- NOC Series(ordinary type) ..... 289-290
- VT Series ..... 291-292
- KNOB Series ..... 293-294
- A2 Series ..... 295-296

## NOC Series (ordinary type)

Tri-proof light is usually used in environment which require water-proof, dust-proof, slight corrosion-proof lighting;and it is widely used in warehouse, parking lot, food field,dust field,cold storage and other places.



Cover of high transmittance,high lighting effect, uniform and soft light

PC cover,impact resistance,IK08

Cover on back, and reserve terminals, convenient to install and connect wire

Milky white cover and transparent cover optional, ceiling mounted or suspending mounted

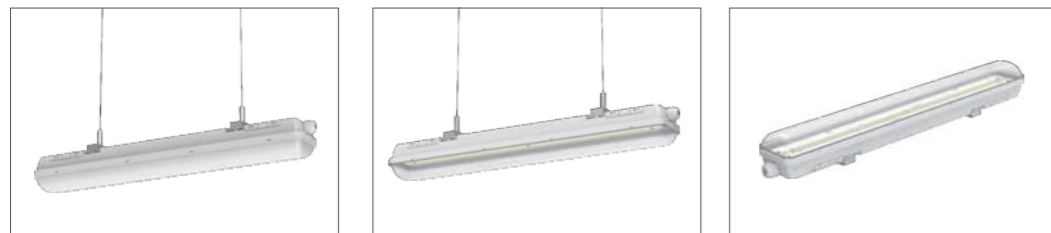

Size:(mm) 10W

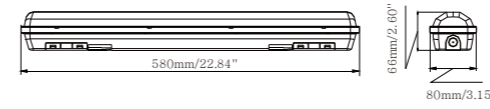

Size:(mm) 20W

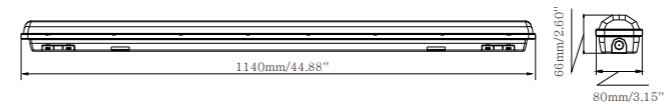
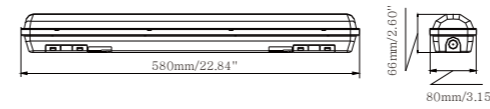

Size:(mm) 25W

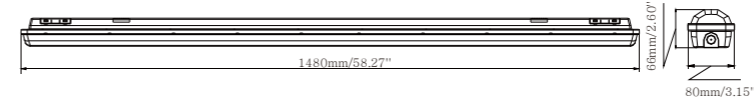

Size:(mm) 40W

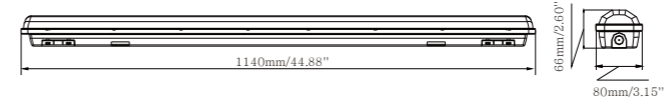

Size:(mm) 50W



Model number	CCT	Light output (±10%)lm	CRI
TPNC06-010-AW-W-01	5500-6500K	1100	>80
TPNC06-010-AW-NW-01	4000-4500K	1080	>80
TPNC06-010-AW-WW-01	2700-3200K	1040	>80
TPNC06-010-AW-W-02	5500-6500K	1050	>80
TPNC06-010-AW-NW-02	4000-4500K	1030	>80
TPNC06-010-AW-WW-02	2700-3200K	990	>80

Model number	CCT	Light output (±10%)lm	CRI
TPNC06-020-AW-W-01	5500-6500K	2210	>80
TPNC06-020-AW-NW-01	4000-4500K	2160	>80
TPNC06-020-AW-WW-01	2700-3200K	2080	>80
TPNC06-020-AW-W-02	5500-6500K	2100	>80
TPNC06-020-AW-NW-02	4000-4500K	2060	>80
TPNC06-020-AW-WW-02	2700-3200K	1980	>80

TPNC12-020-AW-W-01	5500-6500K	2200	>80
TPNC12-020-AW-NW-01	4000-4500K	2160	>80
TPNC12-020-AW-WW-01	2700-3200K	2080	>80
TPNC12-020-AW-W-02	5500-6500K	2100	>80
TPNC12-020-AW-NW-02	4000-4500K	2060	>80
TPNC12-020-AW-WW-02	2700-3200K	1980	>80

Model number	CCT	Light output (±10%)lm	CRI
TPNC15-025-AW-W-01	5500-6500K	2760	>80
TPNC15-025-AW-NW-01	4000-4500K	2700	>80
TPNC15-025-AW-WW-01	2700-3200K	2600	>80
TPNC15-025-AW-W-02	5500-6500K	2630	>80
TPNC15-025-AW-NW-02	4000-4500K	2580	>80
TPNC15-025-AW-WW-02	2700-3200K	2470	>80

Model number	CCT	Light output (±10%)lm	CRI
TPNC12-040-AW-W-01	5500-6500K	4410	>80
TPNC12-040-AW-NW-01	4000-4500K	4330	>80
TPNC12-040-AW-WW-01	2700-3200K	4160	>80
TPNC12-040-AW-W-02	5500-6500K	4200	>80
TPNC12-040-AW-NW-02	4000-4500K	4120	>80
TPNC12-040-AW-WW-02	2700-3200K	3950	>80

Model number	CCT	Light output (±10%)lm	CRI
TPNC15-050-AW-W-01	5500-6500K	5510	>80
TPNC15-050-AW-NW-01	4000-4500K	5400	>80
TPNC15-050-AW-WW-01	2700-3200K	5120	>80
TPNC15-050-AW-W-02	5500-6500K	5250	>80
TPNC15-050-AW-NW-02	4000-4500K	5150	>80
TPNC15-050-AW-WW-02	2700-3200K	4940	>80

# VT Series

Adopt PC as eco-friendly material, and can work stably in different environment; LED lifetime: 50,000 hours.

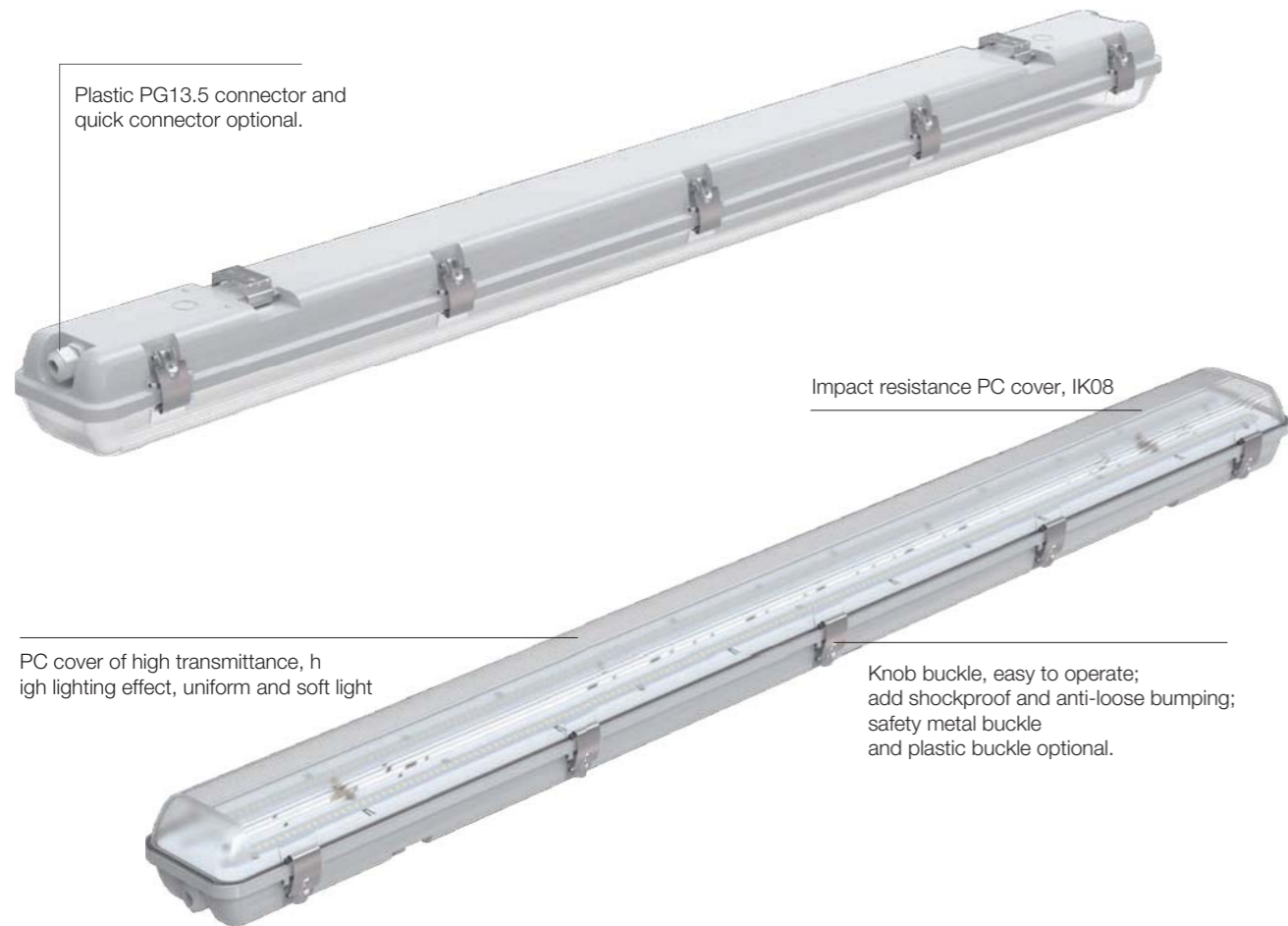

Plastic PG13.5 connector and quick connector optional.

Impact resistance PC cover, IK08

PC cover of high transmittance, high lighting effect, uniform and soft light

Knob buckle, easy to operate; add shockproof and anti-loose bumping; safety metal buckle and plastic buckle optional.

Suspension rope installation

Milky cover/stripes cover

Plastic buckle



Size:(mm/inch) 20W / 30W

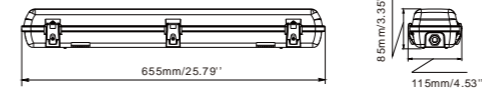

Size:(mm/inch) 30W



Size:(mm/inch) 40W

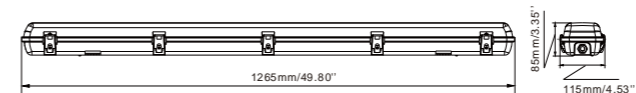

Size:(mm/inch) 50W / 60W

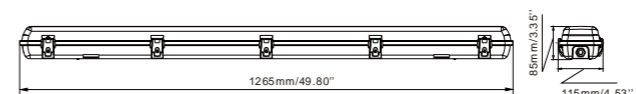

Model number	CCT	Light output (±10%)lm	CRI
VT2F-020-AW-50K-D02	5000K	2800	>80
VT2F-020-AW-40K-D02	4000K	2720	>80
VT2F-020-AW-35K-D02	3500K	2600	>80
VT2F-020-AW-30K-D02	3000K	2600	>80
VT2F-020-AW-50K-S02	5000K	2800	>80
VT2F-020-AW-40K-S02	4000K	2720	>80
VT2F-020-AW-35K-S02	3500K	2600	>80
VT2F-020-AW-30K-S02	3000K	2600	>80

Model number	CCT	Light output (±10%)lm	CRI
VT2F-030-AW-50K-D02	5000K	4200	>80
VT2F-030-AW-40K-D02	4000K	4080	>80
VT2F-030-AW-35K-D02	3500K	3900	>80
VT2F-030-AW-30K-D02	3000K	3900	>80
VT2F-030-AW-50K-S02	5000K	4200	>80
VT2F-030-AW-40K-S02	4000K	4080	>80
VT2F-030-AW-35K-S02	3500K	3900	>80
VT2F-030-AW-30K-S02	3000K	3900	>80

Model number	CCT	Light output (±10%)lm	CRI
VT4F-030-AW-50K-D02	5000K	4200	>80
VT4F-030-AW-40K-D02	4000K	4080	>80
VT4F-030-AW-35K-D02	3500K	3900	>80
VT4F-030-AW-30K-D02	3000K	3900	>80
VT4F-030-AW-50K-S02	5000K	4200	>80
VT4F-030-AW-40K-S02	4000K	4080	>80
VT4F-030-AW-35K-S02	3500K	3900	>80
VT4F-030-AW-30K-S02	3000K	3900	>80

Model number	CCT	Light output (±10%)lm	CRI
VT4F-040-AW-50K-D02	5000K	5600	>80
VT4F-040-AW-40K-D02	4000K	5440	>80
VT4F-040-AW-35K-D02	3500K	5200	>80
VT4F-040-AW-30K-D02	3000K	5200	>80
VT4F-040-AW-50K-S02	5000K	5600	>80
VT4F-040-AW-40K-S02	4000K	5440	>80
VT4F-040-AW-35K-S02	3500K	5200	>80
VT4F-040-AW-30K-S02	3000K	5200	>80

Model number	CCT	Light output (±10%)lm	CRI
VT4F-050-AW-50K-D02	5000K	7000	>80
VT4F-050-AW-40K-D02	4000K	6800	>80
VT4F-050-AW-35K-D02	3500K	6500	>80
VT4F-050-AW-30K-D02	3000K	6500	>80
VT4F-050-AW-50K-S02	5000K	7000	>80
VT4F-050-AW-40K-S02	4000K	6800	>80
VT4F-050-AW-35K-S02	3500K	6500	>80
VT4F-050-AW-30K-S02	3000K	6500	>80

Model number	CCT	Light output (±10%)lm	CRI
VT4F-060-AW-50K-D02	5000K	8400	>80
VT4F-060-AW-40K-D02	4000K	8160	>80
VT4F-060-AW-35K-D02	3500K	7800	>80
VT4F-060-AW-30K-D02	3000K	7800	>80
VT4F-060-AW-50K-S02	5000K	8400	>80
VT4F-060-AW-40K-S02	4000K	8160	>80
VT4F-060-AW-35K-S02	3500K	7800	>80
VT4F-060-AW-30K-S02	3000K	7800	>80

# KNOB Series

KNOB series tri-proof lamps are designed for application sites where waterproof, dustproof and mild corrosion prevention lighting is required such as warehouse, parking lots, foodstuffs factory, dust plant and refrigeratory and other sites.



PC materials for the whole lamp, high impact resistance, IK09

The rotary end cover facilitates to open for wiring and saves more than half of the installation time

High transparent cover, high lighting effect, giving out even and soft light. 100LM/W and 130LM/W for selection

Ceiling mounted or suspending mounted

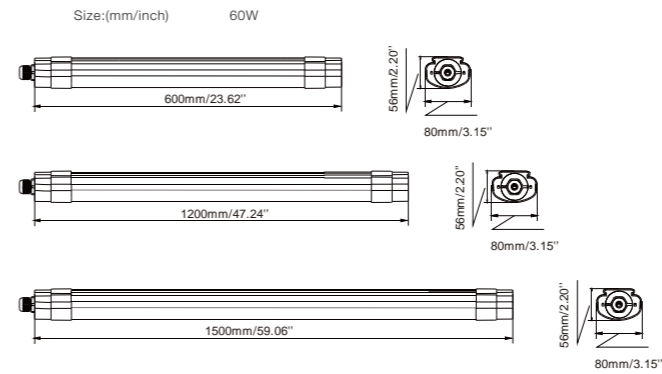
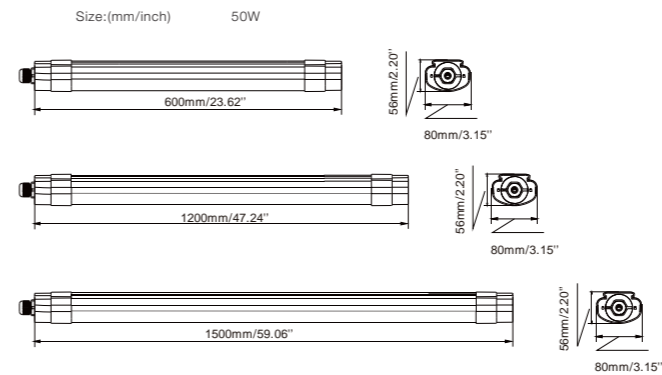
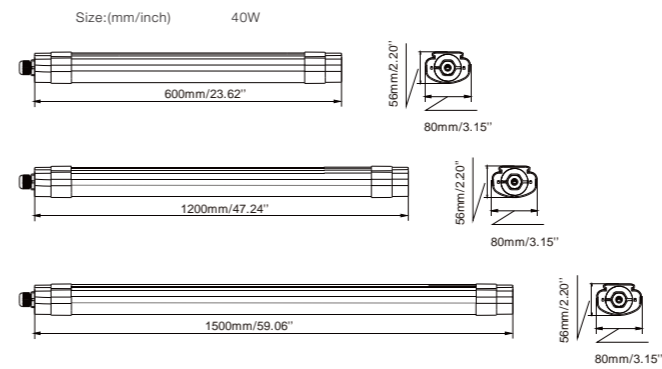
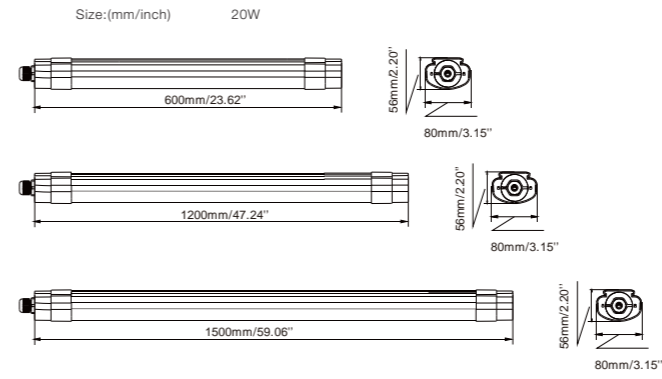

Model number	CCT	Light output (±10%)lm	CRI
TPK-020-AH-W-01/S01	5500-6500K	1890	>80
TPK-020-AH-NW-01/S01	3800-4200K	1860	>80
TPK-020-AH-WW-01/S01	2700-3200K	1800	>80
TPK-020-AH-W-H01/SH01	5500-6500K	2600	>80
TPK-020-AH-NW-H01/SH01	3800-4200K	2500	>80
TPK-020-AH-WW-H01/SH01	2700-3200K	2400	>80

Model number	CCT	Light output (±10%)lm	CRI
TPK-040-AH-W-01/S01	5500-6500K	3960	>80
TPK-040-AH-NW-01/S01	3800-4200K	3800	>80
TPK-040-AH-WW-01/S01	2700-3200K	3680	>80
TPK-040-AH-W-H01/SH01	5500-6500K	5440	>80
TPK-040-AH-NW-H01/SH01	3800-4200K	5360	>80
TPK-040-AH-WW-H01/SH01	2700-3200K	5120	>80

Model number	CCT	Light output (±10%)lm	CRI
TPK-050-AH-W-01/S01	5500-6500K	5100	>80
TPK-050-AH-NW-01/S01	3800-4200K	5000	>80
TPK-050-AH-WW-01/S01	2700-3200K	4750	>80
TPK-050-AH-W-H01/SH01	5500-6500K	6800	>80
TPK-050-AH-NW-H01/SH01	3800-4200K	6700	>80
TPK-050-AH-WW-H01/SH01	2700-3200K	6400	>80

Model number	CCT	Light output (±10%)lm	CRI
TPK-060-AH-W-01/S01	5500-6500K	6240	>80
TPK-060-AH-NW-01/S01	3800-4200K	6000	>80
TPK-060-AH-WW-01/S01	2700-3200K	5700	>80
TPK-060-AH-W-H01/SH01	5500-6500K	8160	>80
TPK-060-AH-NW-H01/SH01	3800-4200K	8040	>80
TPK-060-AH-WW-H01/SH01	2700-3200K	7680	>80

# A2 Series

Tri-proof light is usually used in environment which require water-proof, dust-proof, slight corrosion-proof lighting;and it is widely used in warehouse, parking lot, food field,dust field,cold storage and other places.

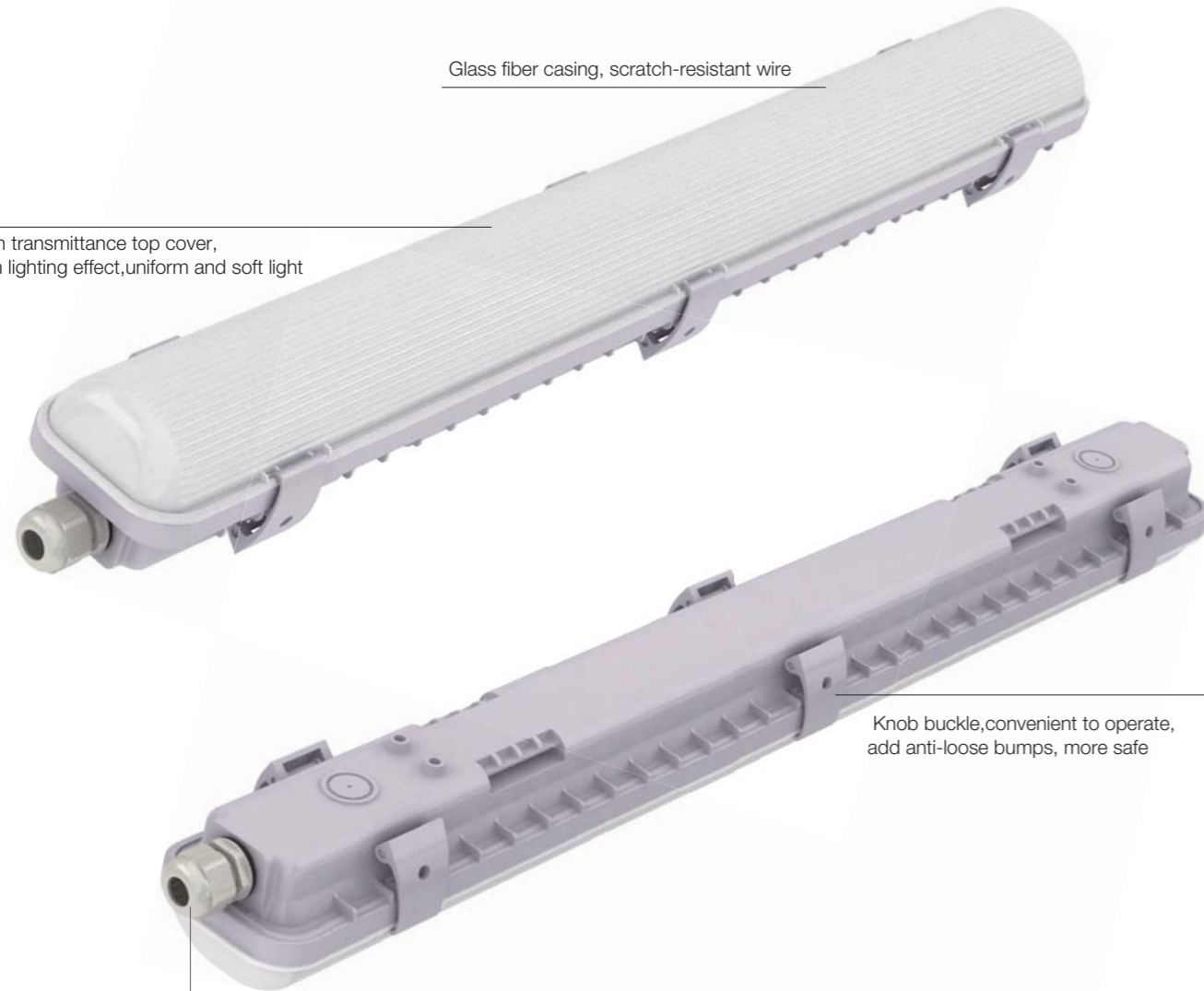

Glass fiber casing, scratch-resistant wire

High transmittance top cover, high lighting effect,uniform and soft light

Knob buckle,convenient to operate, add anti-loose bumps, more safe

Plastic PG11 and quick-connect terminal optional;

Milky white cover and strips cover optional, ceiling and suspendent installation



Size:(mm/inch) 20W

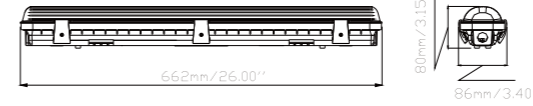

Size:(mm/inch) 40W

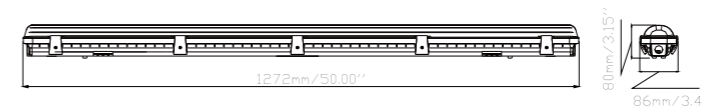

Size:(mm/inch) 50W

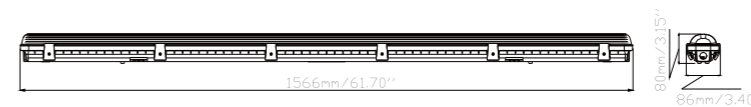

- \*01 = Normal milky cover series
- \*02 = Normal stripe cover series
- \*07 = High brightness series with milky white cover
- \*08 = High brightness series with stripe cover
- \*S = Sensor series

Model number	CCT	Light output (±10%)lm	CRI
TP-020-AW-WA2-01/S01	5500-6500K	2010	>80
TP-020-AW-NWA2-01/S01	4000-4500K	1990	>80
TP-020-AW-WWA2-01/S01	2700-3200K	1900	>80
TP-020-AW-WA2-02/S02	5500-6500K	2200	>80
TP-020-AW-NWA2-02/S02	4000-4500K	2120	>80
TP-020-AW-WWA2-02/S02	2700-3200K	2000	>80

TP-020-AW-WA2-07/S07	5500-6500K	2490	>80
TP-020-AW-NWA2-07/S07	4000-4500K	2470	>80
TP-020-AW-WWA2-07/S07	2700-3200K	2240	>80
TP-020-AW-WA2-08/S08	5500-6500K	2680	>80
TP-020-AW-NWA2-08/S08	4000-4500K	2600	>80
TP-020-AW-WWA2-08/S08	2700-3200K	2300	>80

Model number	CCT	Light output (±10%)lm	CRI
TP-040-AW-WA2-01/S01	5500-6500K	3940	>80
TP-040-AW-NWA2-01/S01	4000-4500K	3900	>80
TP-040-AW-WWA2-01/S01	2700-3200K	3850	>80
TP-040-AW-WA2-02/S02	5500-6500K	4400	>80
TP-040-AW-NWA2-02/S02	4000-4500K	4240	>80
TP-040-AW-WWA2-02/S02	2700-3200K	4000	>80

TP-040-AW-WA2-07/S07	5500-6500K	4920	>80
TP-040-AW-NWA2-07/S07	4000-4500K	4870	>80
TP-040-AW-WWA2-07/S07	2700-3200K	4430	>80
TP-040-AW-WA2-08/S08	5500-6500K	5360	>80
TP-040-AW-NWA2-08/S08	4000-4500K	5200	>80
TP-040-AW-WWA2-08/S08	2700-3200K	4600	>80

Model number	CCT	Light output (±10%)lm	CRI
TP-050-AW-WA2-01/S01	5500-6500K	4570	>80
TP-050-AW-NWA2-01/S01	4000-4500K	4520	>80
TP-050-AW-WWA2-01/S01	2700-3200K	4430	>80
TP-050-AW-WA2-02/S02	5500-6500K	5500	>80
TP-050-AW-NWA2-02/S02	4000-4500K	5300	>80
TP-050-AW-WWA2-02/S02	2700-3200K	5000	>80

TP-050-AW-WA2-07/S07	5500-6500K	6060	>80
TP-050-AW-NWA2-07/S07	4000-4500K	6000	>80
TP-050-AW-WWA2-07/S07	2700-3200K	5390	>80
TP-050-AW-WA2-08/S08	5500-6500K	6700	>80
TP-050-AW-NWA2-08/S08	4000-4500K	6500	>80
TP-050-AW-WWA2-08/S08	2700-3200K	5750	>80

# Tri-proof Lamp



Scale: 1 : 50

Gestione della luce: corpo  
**in alluminio** e vano ottico  
verniciati di nero

Industrial Area / Educational Building / Calculation surface 4 / Isolines/Horizontal illuminance  
Calculation surface 4 / Isolines/Horizontal illuminance

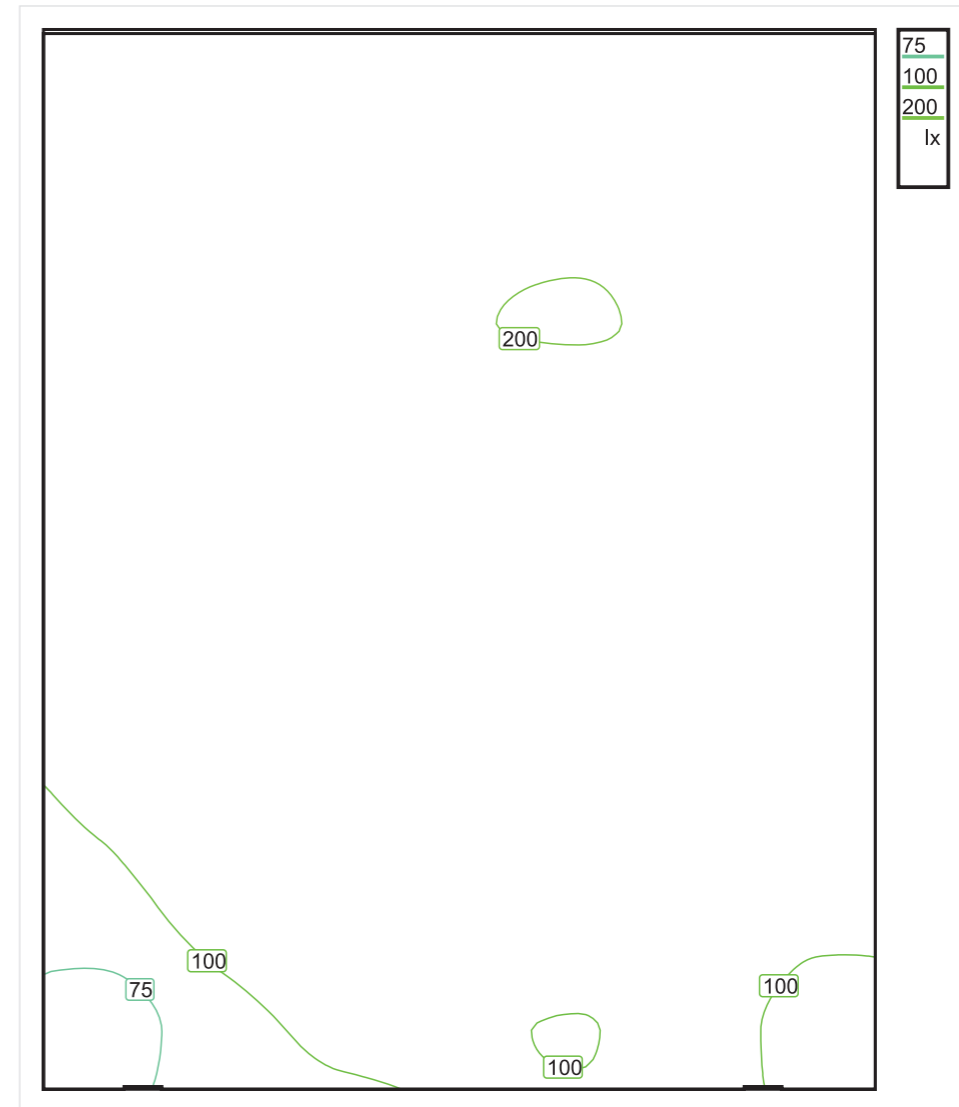

Horizontal illuminance (Grid)  
Average: 149 lx, Min: 66 lx, Max: 201 lx, Min/average: 0.445, Min/max: 0.328, Points: 7 x 9 (Relevant: all)



# Wall Pack

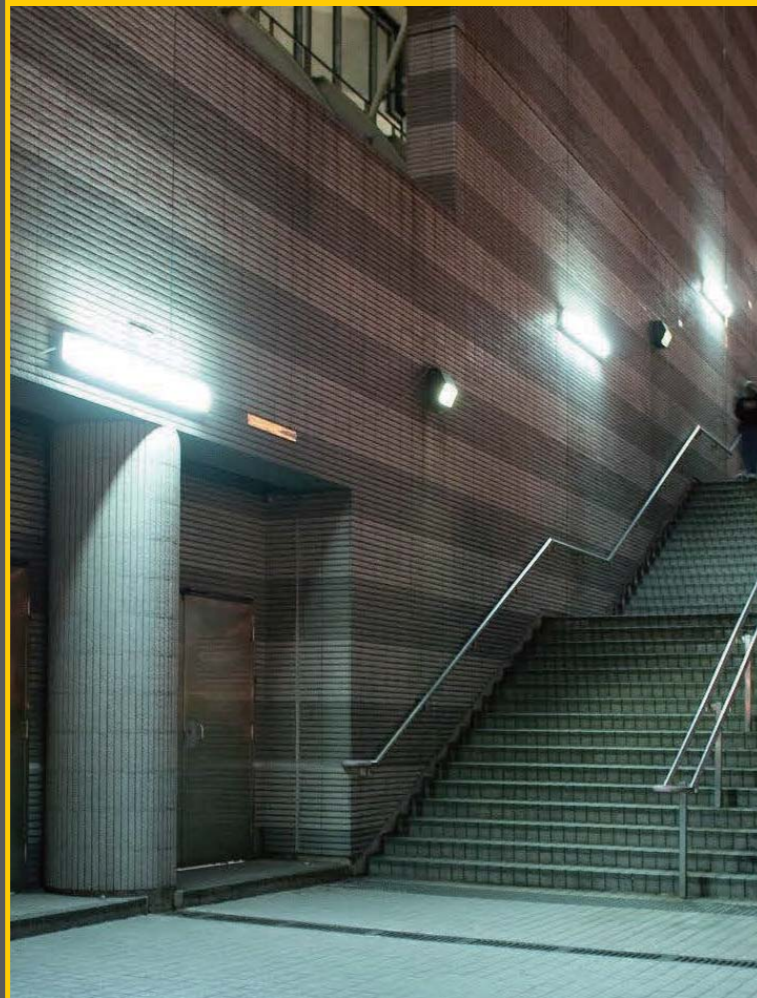

- Wall Pack ..... 301-302
- Mini Wall Pack ..... 303-304

# Wall Pack



Using small drive current, LED package will have a longer lifespan. With rapid installation bracket, no extra disassembly or assembly during the installation

The die-cast fixture after anti corrosion treatment is heavy-duty and reliable.

Polyester powder-coated finish, rust and corrosion proof

Use a unique heat sink design to shorten the thermal pass way

Optional: sunshade

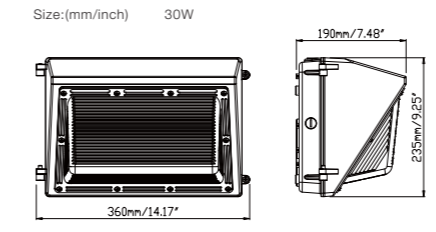

Model number	CCT	Light output (±10%)lm	CRI
WPHC-030-AW-W	5000K	2990	>80
WPHC-030-AW-NW	4000K	2960	>80
WPHC-030-AW-WW	3000K	2830	>80

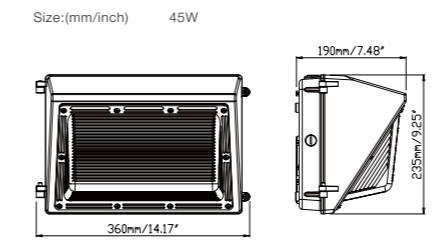

Model number	CCT	Light output (±10%)lm	CRI
WPHC-045-AW-W	5000K	4940	>80
WPHC-045-AW-NW	4000K	4890	>80
WPHC-045-AW-WW	3000K	4840	>80

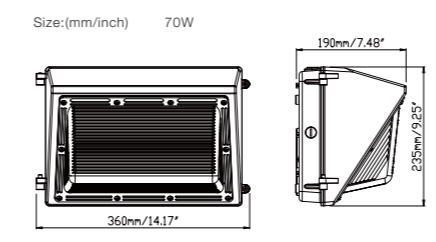

Model number	CCT	Light output (±10%)lm	CRI
WPHC-070-AW-W	5000K	7600	>80
WPHC-070-AW-NW	4000K	7500	>80
WPHC-070-AW-WW	3000K	7290	>80

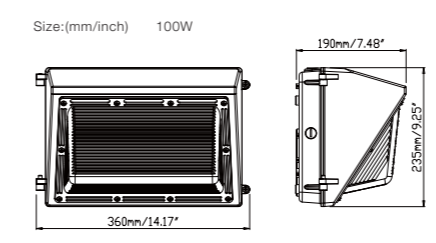

Model number	CCT	Light output (±10%)lm	CRI
WPHC-100AW-W	5000K	11040	>80
WPHC-100-AW-NW	4000K	10920	>80
WPHC-100-AW-WW	3000K	10790	>80

# Mini Wall Pack

Convenient installation,  
whole installation in 2 minutes

Light sensation control (option)

Customized mold products,  
12W/24W available for selection

With IP65, long-term outdoor use



Size:(mm/inch) 12W / 24W

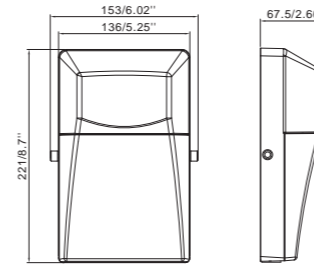

Model number	CCT	Light output (±10%)lm	CRI
WPM-012-AW-50K-ZYY	5000K	1630	>80
WPM-012-AW-40K-ZYY	4000K	1590	>80
WPM-012-AW-30K-ZYY	3000K	1550	>80
WPM-024-AW-50K-ZYY	5000K	3070	>80
WPM-024-AW-40K-ZYY	4000K	3000	>80
WPM-024-AW-30K-ZYY	3000K	2900	>80



# Area Light



■ Area Lights ..... 307-308

■ Shoebox ..... 309-310

# Area Lights



4 beam angles optional,  
Typell / TypeIII / Type IV / Type V

130 LPW lighting effect

Die-casting design, more durable, stronger

### Different brackets:



Size:(mm/inch) 100W

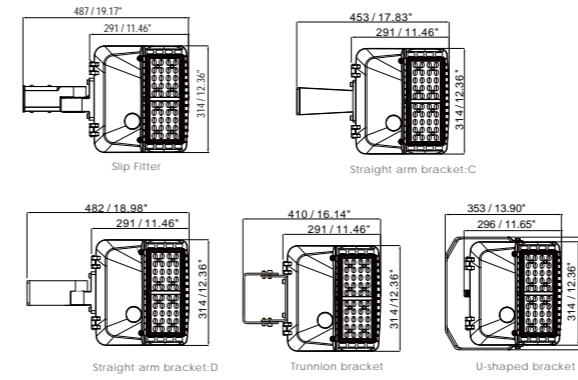

Size:(mm/inch) 150W/200W

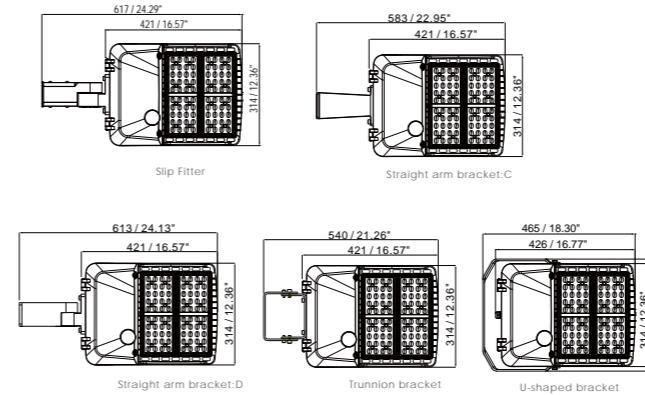

Size:(mm/inch) 240W/300W

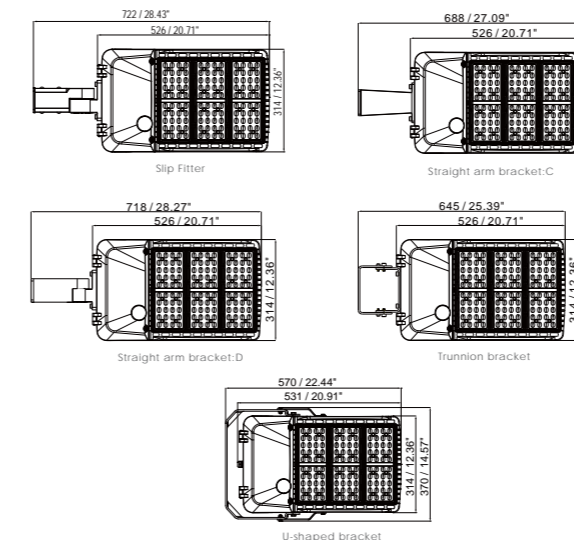

Model number	CCT	Light output (±10%/lm)	CRI
AL-100-AW-57K-D10/20/30/40	5700K	13000	>80
AL-100-AW-50K-D10/20/30/40	5000K	13000	>80
AL-100-AW-40K-D10/20/30/40	4000K	12500	>80
AL-100-AW-30K-D10/20/30/40	3000K	12000	>80

AL-100-HV-57K-D10/20/30/40	5700K	13000	>80
AL-100-HV-50K-D10/20/30/40	5000K	13000	>80
AL-100-HV-40K-D10/20/30/40	4000K	12500	>80
AL-100-HV-30K-D10/20/30/40	3000K	12000	>80

Model number	CCT	Light output (±10%/lm)	CRI
AL-150-AW-57K-D10/20/30/40	5700K	19500	>80
AL-150-AW-50K-D10/20/30/40	5000K	19500	>80
AL-150-AW-40K-D10/20/30/40	4000K	18700	>80
AL-150-AW-30K-D10/20/30/40	3000K	18000	>80

AL-150-HV-57K-D10/20/30/40	5700K	19500	>80
AL-150-HV-50K-D10/20/30/40	5000K	19500	>80
AL-150-HV-40K-D10/20/30/40	4000K	18700	>80
AL-150-HV-30K-D10/20/30/40	3000K	18000	>80

Model number	CCT	Light output (±10%/lm)	CRI
AL-200-AW-57K-D10/20/30/40	5700K	25700	>80
AL-200-AW-50K-D10/20/30/40	5000K	25700	>80
AL-200-AW-40K-D10/20/30/40	4000K	25000	>80
AL-200-AW-30K-D10/20/30/40	3000K	23800	>80

AL-200-HV-57K-D10/20/30/40	5700K	25700	>80
AL-200-HV-50K-D10/20/30/40	5000K	25700	>80
AL-200-HV-40K-D10/20/30/40	4000K	25000	>80
AL-200-HV-30K-D10/20/30/40	3000K	23800	>80

Model number	CCT	Light output (±10%/lm)	CRI
AL-240-AW-57K-D10/20/30/40	5700K	31200	>80
AL-240-AW-50K-D10/20/30/40	5000K	31200	>80
AL-240-AW-40K-D10/20/30/40	4000K	30000	>80
AL-240-AW-30K-D10/20/30/40	3000K	28800	>80

AL-240-HV-57K-D10/20/30/40	5700K	31200	>80
AL-240-HV-50K-D10/20/30/40	5000K	31200	>80
AL-240-HV-40K-D10/20/30/40	4000K	30000	>80
AL-240-HV-30K-D10/20/30/40	3000K	28800	>80

Model number	CCT	Light output (±10%/lm)	CRI
AL-300-AW-57K-D10/20/30/40	5700K	39000	>80
AL-300-AW-50K-D10/20/30/40	5000K	39000	>80
AL-300-AW-40K-D10/20/30/40	4000K	37500	>80
AL-300-AW-30K-D10/20/30/40	3000K	36000	>80

AL-300-HV-57K-D10/20/30/40	5700K	39000	>80
AL-300-HV-50K-D10/20/30/40	5000K	39000	>80
AL-300-HV-40K-D10/20/30/40	4000K	37500	>80
AL-300-HV-30K-D10/20/30/40	3000K	36000	>80

# Shoebox II Series

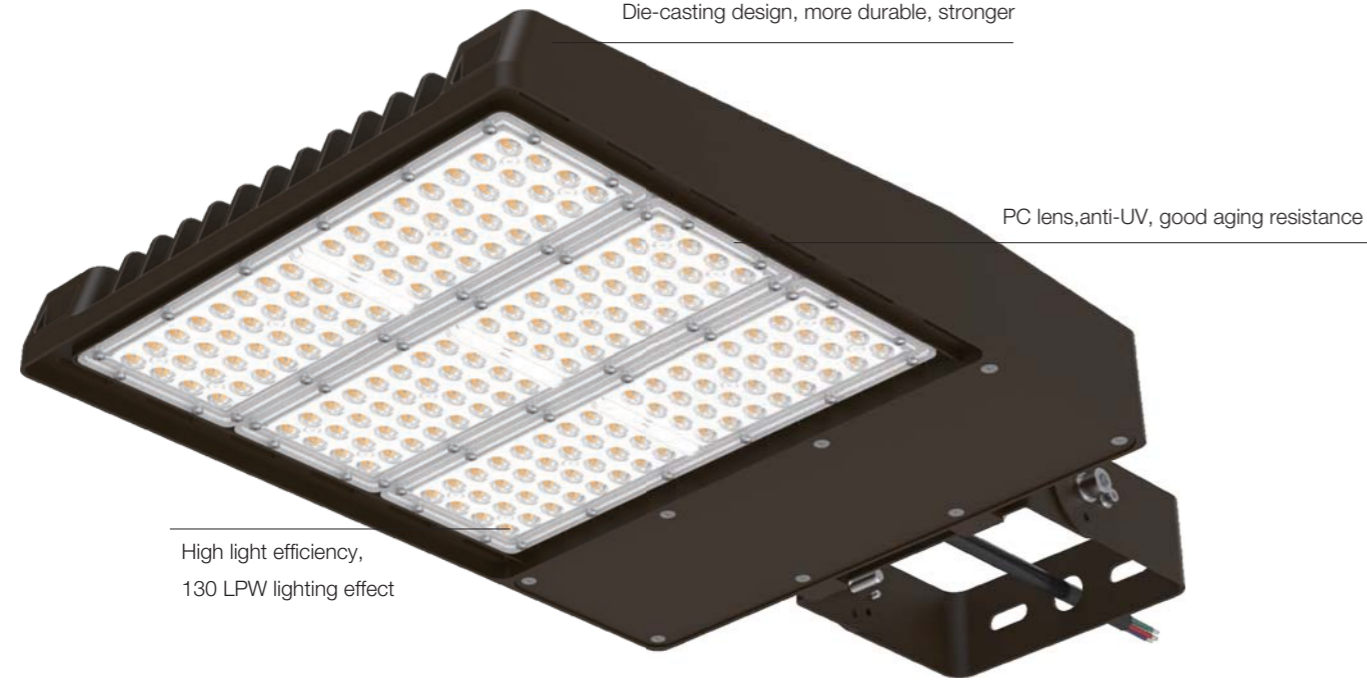

Die-casting design, more durable, stronger

PC lens, anti-UV, good aging resistance

High light efficiency,  
130 LPW lighting effect

One modules      Two modules      Three modules      Four modules



Accessories



Size:(mm/inch)      100W

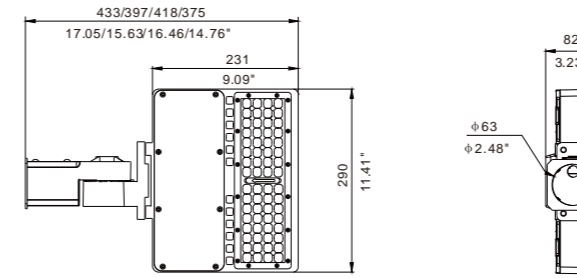

Size:(mm/inch)      150W/190W

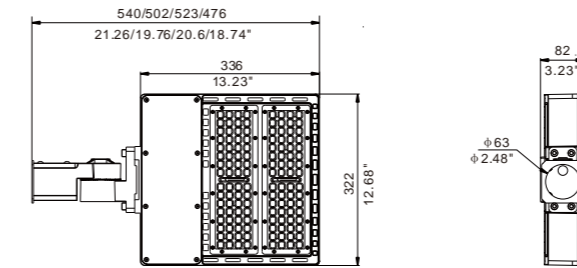

Size:(mm/inch)      240W

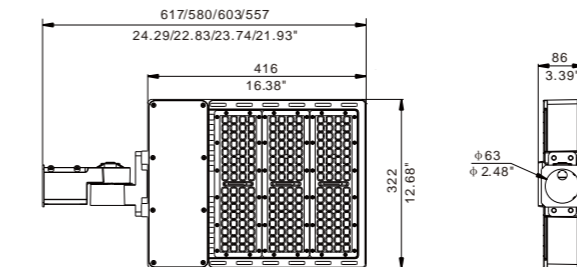

Size:(mm/inch)      300W

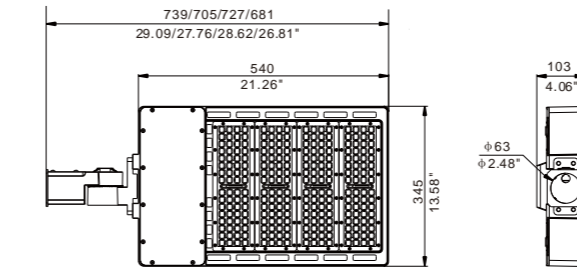

Model number	CCT	Light output (±10%)lm	CRI
SB2-100-AW-57K-ZYY	5700K	13000	>80
SB2-100-AW-50K-ZYY	5000K	13000	>80
SB2-100-AW-40K-ZYY	4000K	12500	>80
SB2-100-AW-30K-ZYY	3000K	12000	>80

Model number	CCT	Light output (±10%)lm	CRI
SB2-150-AW-57K-ZYY	5700K	19500	>80
SB2-150-AW-50K-ZYY	5000K	19500	>80
SB2-150-AW-40K-ZYY	4000K	18700	>80
SB2-150-AW-30K-ZYY	3000K	18000	>80
SB2-190-AW-57K-ZYY	5700K	24700	>80
SB2-190-AW-50K-ZYY	5000K	24700	>80
SB2-190-AW-40K-ZYY	4000K	23700	>80
SB2-190-AW-30K-ZYY	3000K	22800	>80

Model number	CCT	Light output (±10%)lm	CRI
SB2-240-AW-57K-ZYY	5700K	31200	>80
SB2-240-AW-50K-ZYY	5000K	31200	>80
SB2-240-AW-40K-ZYY	4000K	30000	>80
SB2-240-AW-30K-ZYY	3000K	28800	>80

Model number	CCT	Light output (±10%)lm	CRI
SB2-300-AW-57K-ZYY	5700K	39000	>80
SB2-300-AW-50K-ZYY	5000K	39000	>80
SB2-300-AW-40K-ZYY	4000K	37500	>80
SB2-300-AW-30K-ZYY	3000K	36000	>80

# LED Corn Bulb



- LED Corn Bulb ..... 313-320
- 180° LED Corn Bulb ..... 321-324
- HICO Smart LED Corn Bulb ..... 325-326

# LED Corn Bulb



Size:(in.) 80W

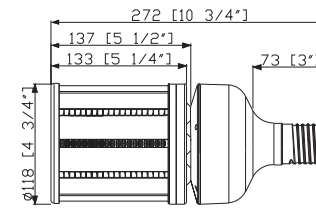

Model number	CCT	Light output (±10%)lm	CRI
QR39-080-AW-W-01	5000K	11080	>80
QR39-080-AW-NW-01	4000K	10550	>80
QR39-080-AW-WW-01	3000K	9820	>80
QR39-080-AW-W	5000K	9670	>80
QR39-080-AW-NW	4000K	9210	>80
QR39-080-AW-WW	3000K	8470	>80

Size:(in.) 100W

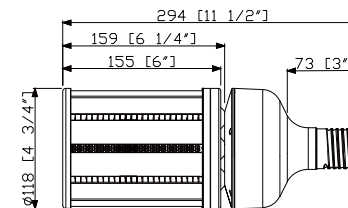

Model number	CCT	Light output (±10%)lm	CRI
QR39-100-AW-W-01	5000K	14030	>80
QR39-100-AW-NW-01	4000K	13360	>80
QR39-100-AW-WW-01	3000K	12420	>80
QR39-100-AW-W	5000K	11920	>80
QR39-100-AW-NW	4000K	11360	>80
QR39-100-AW-WW	3000K	10450	>80

Size:(in.) 120W

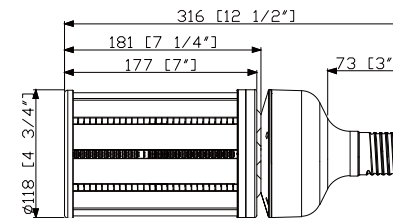

Model number	CCT	Light output (±10%)lm	CRI
QR39-120-AW-W-01	5000K	16720	>80
QR39-120-AW-NW-01	4000K	15920	>80
QR39-120-AW-WW-01	3000K	14810	>80
QR39-120-AW-W	5000K	14310	>80
QR39-120-AW-NW	4000K	13630	>80
QR39-120-AW-WW	3000K	12530	>80

Size:(in.) 140W

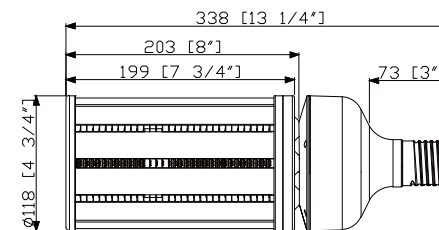

Model number	CCT	Light output (±10%)lm	CRI
QR39-140-AW-W-01	5000K	19460	>80
QR39-140-AW-NW-01	4000K	18540	>80
QR39-140-AW-WW-01	3000K	17240	>80
QR39-140-AW-W	5000K	16880	>80
QR39-140-AW-NW	4000K	16080	>80
QR39-140-AW-WW	3000K	14790	>80





# FOTACH LED Corn Bulb



Size:(in.) 27W

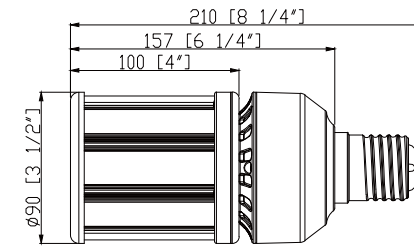

Size:(in.) 36W

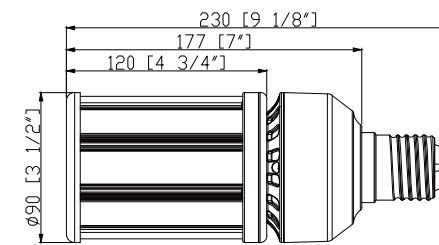

Size:(in.) 45W

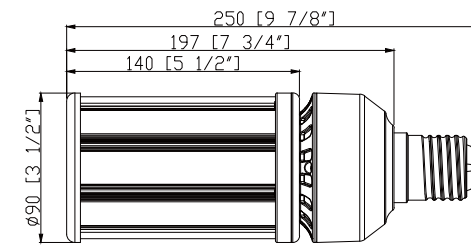

Size:(in.) 54W

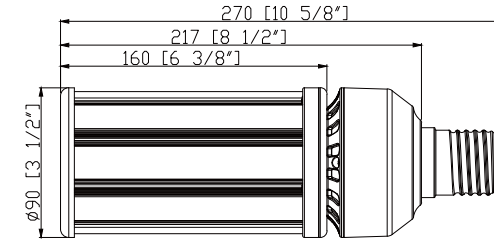

Model number	CCT	Light output (±10%)lm	CRI
QR39-027-AW-W	5000K	3570	>80
QR39-027-AW-NW	4000K	3400	>80
QR39-027-AW-WW	3000K	3120	>80
QR39-027-AW-W-01H1	5000K	3980	>80
QR39-027-AW-NW-01H1	4000K	3960	>80
QR39-027-AW-WW-01H1	3000K	3860	>80

Model number	CCT	Light output (±10%)lm	CRI
QR39-036-AW-W	5000K	5010	>80
QR39-036-AW-NW	4000K	4780	>80
QR39-036-AW-WW	3000K	4390	>80
QR39-036-AW-W-01H1	5000K	5300	>80
QR39-036-AW-NW-01H1	4000K	5230	>80
QR39-036-AW-WW-01H1	3000K	4970	>80

Model number	CCT	Light output (±10%)lm	CRI
QR39-045-AW-W	5000K	6380	>80
QR39-045-AW-NW	4000K	6080	>80
QR39-045-AW-WW	3000K	5590	>80
QR39-045-AW-W-01H1	5000K	6610	>80
QR39-045-AW-NW-01H1	4000K	6620	>80
QR39-045-AW-WW-01H1	3000K	6050	>80

Model number	CCT	Light output (±10%)lm	CRI
QR39-054-AW-W	5000K	7440	>80
QR39-054-AW-NW	4000K	7090	>80
QR39-054-AW-WW	3000K	6520	>80
QR39-054-AW-W-01H1	5000K	8100	>80
QR39-054-AW-NW-01H1	4000K	8080	>80
QR39-054-AW-WW-01H1	3000K	7790	>80



# LED Corn Bulb

Pure aluminum 1070,  
perfect heat dissipation

PC with flame retardant material

Max. 120lm/W



Size:(in.) 12W

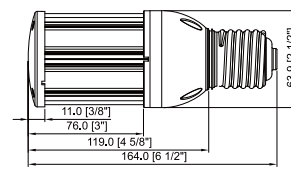

E39

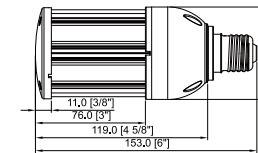

E26

Size:(in.) 20W

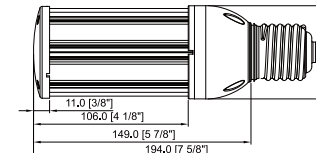

E39

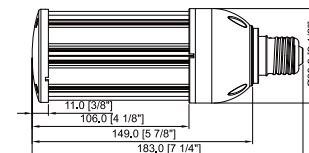

E26

Size:(in.) 27W

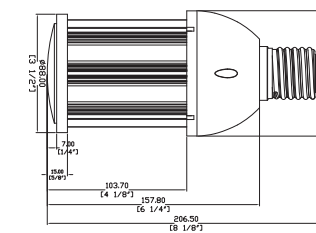

E39

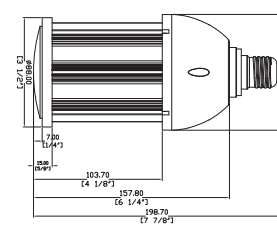

E26

Size:(in.) 36W

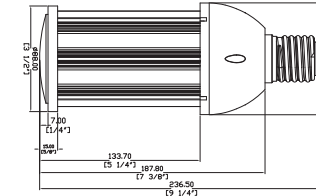

E39

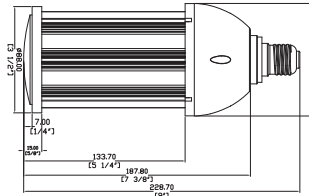

E26

Size:(in.) 45W

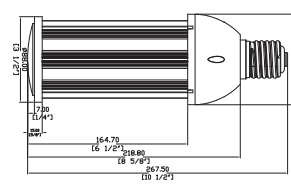

E39

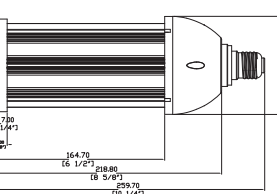

E26

Size:(in.) 54W

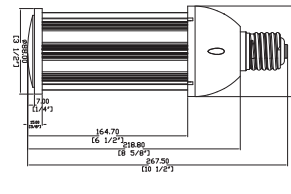

E39

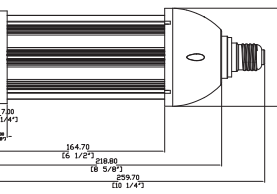

E26

Model number	CCT	Light output (±10%/lm)	CRI
FR26-012-AW-W-01	5500-7000K	1400	>80
FR26-012-AW-NW-01	4000-4500K	1300	>80
FR26-012-AW-WW-01	2700-3200K	1220	>80
FR39-012-AW-W-02	5500-7000K	1400	>80
FR39-012-AW-NW-02	4000-4500K	1300	>80
FR39-012-AW-WW-02	2700-3200K	1220	>80

Model number	CCT	Light output (±10%/lm)	CRI
FR26-020-AW-W-01	5500-7000K	2300	>80
FR26-020-AW-NW-01	4000-4500K	2050	>80
FR26-020-AW-WW-01	2700-3200K	1900	>80
FR39-020-AW-W-02	5500-7000K	2300	>80
FR39-020-AW-NW-02	4000-4500K	2050	>80
FR39-020-AW-WW-02	2700-3200K	1900	>80

Model number	CCT	Light output (±10%/lm)	CRI
FR26-027-AW-W-01	5500-7000K	3200	>80
FR26-027-AW-NW-01	4000-4500K	2800	>80
FR26-027-AW-WW-01	2700-3200K	2620	>80
FR39-027-AW-W-02	5500-7000K	3200	>80
FR39-027-AW-NW-02	4000-4500K	2800	>80
FR39-027-AW-WW-02	2700-3200K	2620	>80

Model number	CCT	Light output (±10%/lm)	CRI
FR26-036-AW-W-01	5500-7000K	4200	>80
FR26-036-AW-NW-01	4000-4500K	3900	>80
FR26-036-AW-WW-01	2700-3200K	3450	>80
FR39-036-AW-W-02	5500-7000K	4200	>80
FR39-036-AW-NW-02	4000-4500K	3900	>80
FR39-036-AW-WW-02	2700-3200K	3450	>80

Model number	CCT	Light output (±10%/lm)	CRI
FR26-045-AW-W-01	5500-7000K	5400	>80
FR26-045-AW-NW-01	4000-4500K	5100	>80
FR26-045-AW-WW-01	2700-3200K	4500	>80
FR39-045-AW-W-02	5500-7000K	5400	>80
FR39-045-AW-NW-02	4000-4500K	5100	>80
FR39-045-AW-WW-02	2700-3200K	4500	>80

Model number	CCT	Light output (±10%/lm)	CRI
FR26-054-AW-W-01	5500-7000K	6400	>80
FR26-054-AW-NW-01	4000-4500K	6200	>80
FR26-054-AW-WW-01	2700-3200K	5400	>80
FR39-054-AW-W-02	5500-7000K	6400	>80
FR39-054-AW-NW-02	4000-4500K	6200	>80
FR39-054-AW-WW-02	2700-3200K	5400	>80

# LED Corn Bulb

Green lighting is trend of future, no UV, no IR, no flicker, and mercury free, so it has no harm to human body .

iLight corn lamp is developed at the right moment and aims at replacing mercury lamp,HQI, HPS, MHL and CFL. It can replace traditional lamp of higher power because of its high light efficiency 150lm/W, and more energy-saving compared with 100lm/w.With power 12-54W, the corn lamp can replace 250W HPS/MHL.Light source adopt well-known SEOUL SMD, high light efficiency, low light decay.

The lamp body is made of full aluminum 1070, excellent thermal management. IP 64, can be used as indoor highbay &lowbay and outdoor garden lamp, street lamp.

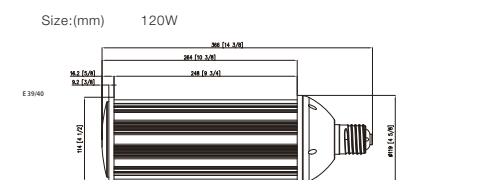
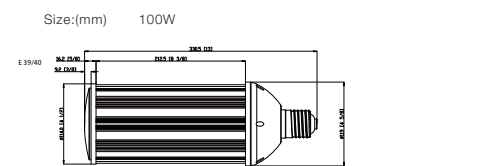
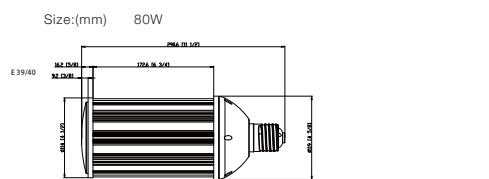
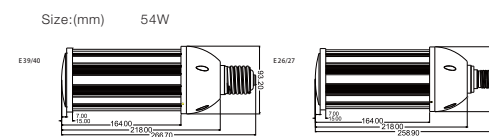
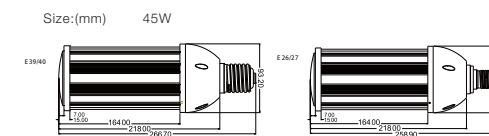
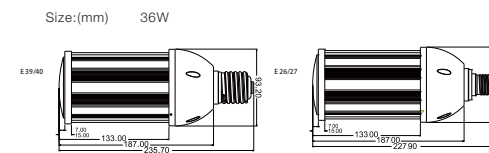
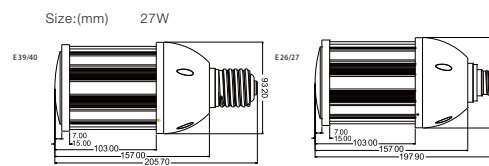
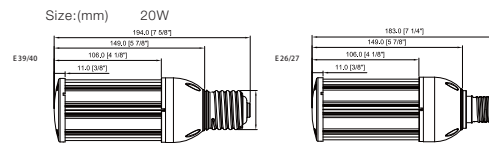
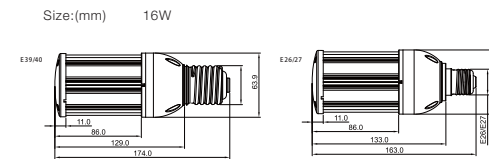
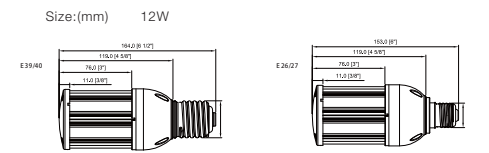

Model number	CCT	Light output (±10%)lm	CRI
FR-012-AW-W-01H/02H	4700-5300K	1850	>80
FR-012-AW-NW-01H/02H	3700-4200K	1800	>80
FR-012-AW-WW-01H/02H	2900-3200K	1650	>80

Model number	CCT	Light output (±10%)lm	CRI
FR-016-AW-W-01H/02H	4700-5300K	2250	>80
FR-016-AW-NW-01H/02H	3700-4200K	2200	>80
FR-016-AW-WW-01H/02H	2900-3200K	2150	>80

Model number	CCT	Light output (±10%)lm	CRI
FR-020-AW-W-01H/02H	4700-5300K	3050	>80
FR-020-AW-NW-01H/02H	3700-4200K	3000	>80
FR-020-AW-WW-01H/02H	2900-3200K	2920	>80

Model number	CCT	Light output (±10%)lm	CRI
FR-027-AW-W-01H/02H	4700-5300K	4100	>80
FR-027-AW-NW-01H/02H	3700-4200K	4050	>80
FR-027-AW-WW-01H/02H	2900-3200K	3900	>80

Model number	CCT	Light output (±10%)lm	CRI
FR-036-AW-W-01H/02H	4700-5300K	5580	>80
FR-036-AW-NW-01H/02H	3700-4200K	5400	>80
FR-036-AW-WW-01H/02H	2900-3200K	5220	>80

Model number	CCT	Light output (±10%)lm	CRI
FR-045-AW-W-01H/02H	4700-5300K	6960	>80
FR-045-AW-NW-01H/02H	3700-4200K	6750	>80
FR-045-AW-WW-01H/02H	2900-3200K	6570	>80

Model number	CCT	Light output (±10%)lm	CRI
FR-054-AW-W-01H/02H	4700-5300K	8375	>80
FR-054-AW-NW-01H/02H	3700-4200K	8230	>80
FR-054-AW-WW-01H/02H	2900-3200K	7730	>80

Model number	CCT	Light output (±10%)lm	CRI
FR-080-AW-W-01H/02H	4700-5300K	12240	>80
FR-080-AW-NW-01H/02H	3700-4200K	11960	>80
FR-080-AW-WW-01H/02H	2900-3200K	10670	>80

Model number	CCT	Light output (±10%)lm	CRI
FR-100-AW-W-01H/02H	4700-5300K	15050	>80
FR-100-AW-NW-01H/02H	3700-4200K	14460	>80
FR-100-AW-WW-01H/02H	2900-3200K	13680	>80

Model number	CCT	Light output (±10%)lm	CRI
FR-120-AW-W-01H/02H	4700-5300K	18280	>80
FR-120-AW-NW-01H/02H	3700-4200K	17900	>80
FR-120-AW-WW-01H/02H	2900-3200K	16460	>80

# 180 Degree LED Corn Bulb



LED expose directly, ensure max. lighting effect of lamp

Unique cooling design in junction with fan, excellent thermal management, ensure long lifespan of LEDs

Lamp can rotate in 350° orientable, 180° luminescence, high lighting effect, high energy saving

Adopt aluminum alloy as main body material, and adopt extrusion profile process



Size:(mm) 30W

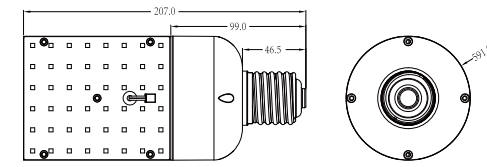

Model number	CCT	Light output (±10%)lm	CRI
SR39-030-AW-W-01	5000K	3600	>80
SR39-030-AW-NW-01	4000K	3400	>80
SR39-030-AW-WW-01	3000K	3200	>80

Size:(mm) 40W

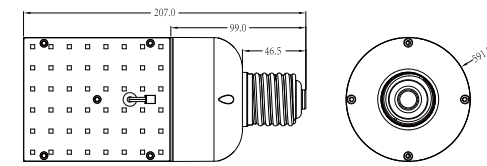

Model number	CCT	Light output (±10%)lm	CRI
SR39-040-AW-W-01	5000K	4500	>80
SR39-040-AW-NW-01	4000K	4750	>80
SR39-040-AW-WW-01	3000K	4230	>80

Size:(mm) 50W

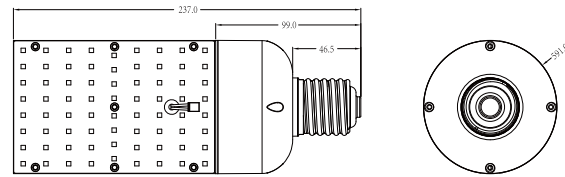

Model number	CCT	Light output (±10%)lm	CRI
SR39-050-AW-W-01	5000K	6370	>80
SR39-050-AW-NW-01	4000K	6020	>80
SR39-050-AW-WW-01	3000K	5680	>80

Size:(in) 60W

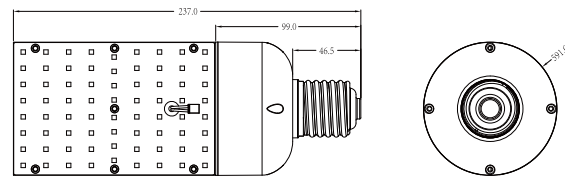

Model number	CCT	Light output (±10%)lm	CRI
SR39-060-AW-W-01	5000K	7530	>80
SR39-060-AW-NW-01	4000K	7110	>80
SR39-060-AW-WW-01	3000K	6700	>80

# 180 Degree LED Corn Bulb



High Brightness: LED expose directly, ensure max. lighting effect of lamp; Normal Brightness: Increase the transparent cover

Adopt aluminum alloy as main body material, and adopt extrusion profile process

Can be rotated in 350degree so that make sure light in any direction. 180degree light beam delivers a high light output max.

Unique cooling design in junction with fan, excellent thermal management, ensure long lifespan of LEDs

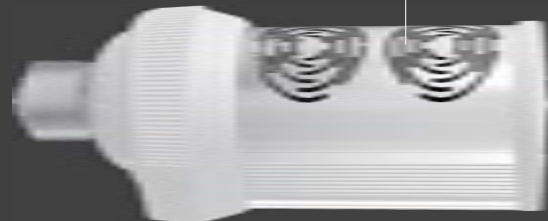

Size:(mm) 80W

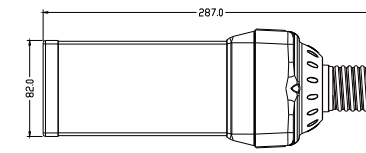

Normal Brightness

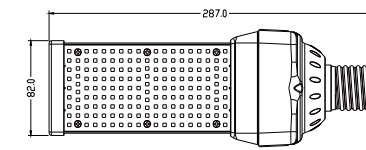
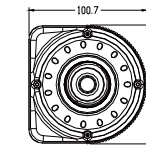

Hight Brightness

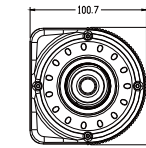

Size:(mm) 100W

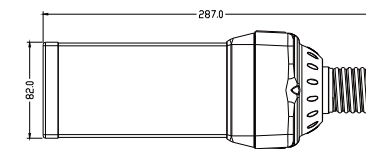

Normal Brightness

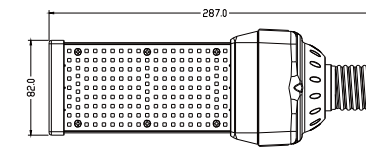
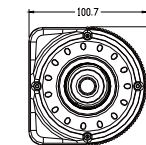

Hight Brightness

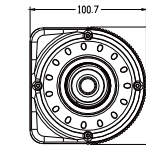

Size:(mm) 120W

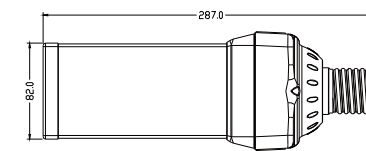

Normal Brightness

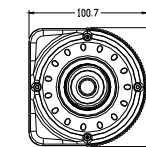

Model number	CCT	Light output (±10%)lm	CRI
SR39-080-AW-W-01	5000K	9240	>80
SR39-080-AW-NW-01	4000K	9875	>80
SR39-080-AW-WW-01	3000K	10088	>80
SR39-080-AW-W-01H	5000K	10065	>80
SR39-080-AW-NW-01H	4000K	10750	>80
SR39-080-AW-WW-01H	3000K	10985	>80

Model number	CCT	Light output (±10%)lm	CRI
SR39-100-AW-W-01	5000K	11790	>80
SR39-100-AW-NW-01	4000K	12660	>80
SR39-100-AW-WW-01	3000K	12500	>80
SR39-100-AW-W-01H	5000K	12840	>80
SR39-100-AW-NW-01H	4000K	13785	>80
SR39-100-AW-WW-01H	3000K	13620	>80

Model number	CCT	Light output (±10%)lm	CRI
SR39-120-AW-W-01	5000K	14148	>80
SR39-120-AW-NW-01	4000K	15370	>80
SR39-120-AW-WW-01	3000K	15300	>80

# HICO Smart LED Corn Bulb

High quality driver components:  
SHINDENGEN IC, MOS and diodes ( Japan )  
Rubycon capacitors ( Japan )  
Operating temperature -35-60 C .



Aluminium alloy,  
more conducive to head dissipation

Extruded aluminum alloy

2835 SMD whole lamp 150LM/W(4000K)

TE connector



Size:(mm) 80W

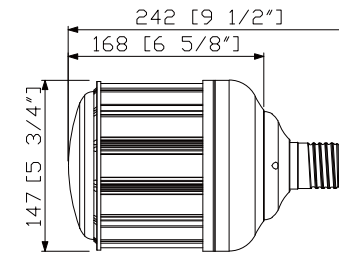

Model number	CCT	Light output (±10%/lm)	CRI
HC39-080-AW-850K	5000K	11740	>80
HC39-080-AW-840K	4000K	11260	>80
HC39-080-AW-830K	3000K	10900	>80

Size:(mm) 100W

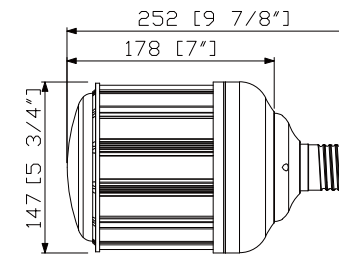

Model number	CCT	Light output (±10%/lm)	CRI
HC39-100-AW-850K	5000K	14720	>80
HC39-100-AW-840K	4000K	13980	>80
HC39-100-AW-830K	3000K	13640	>80

Size:(mm) 120W

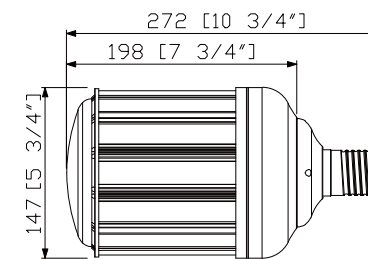

Model number	CCT	Light output (±10%/lm)	CRI
HC39-120-AW-850K	5000K	17650	>80
HC39-120-AW-840K	4000K	17110	>80
HC39-120-AW-830K	3000K	16450	>80

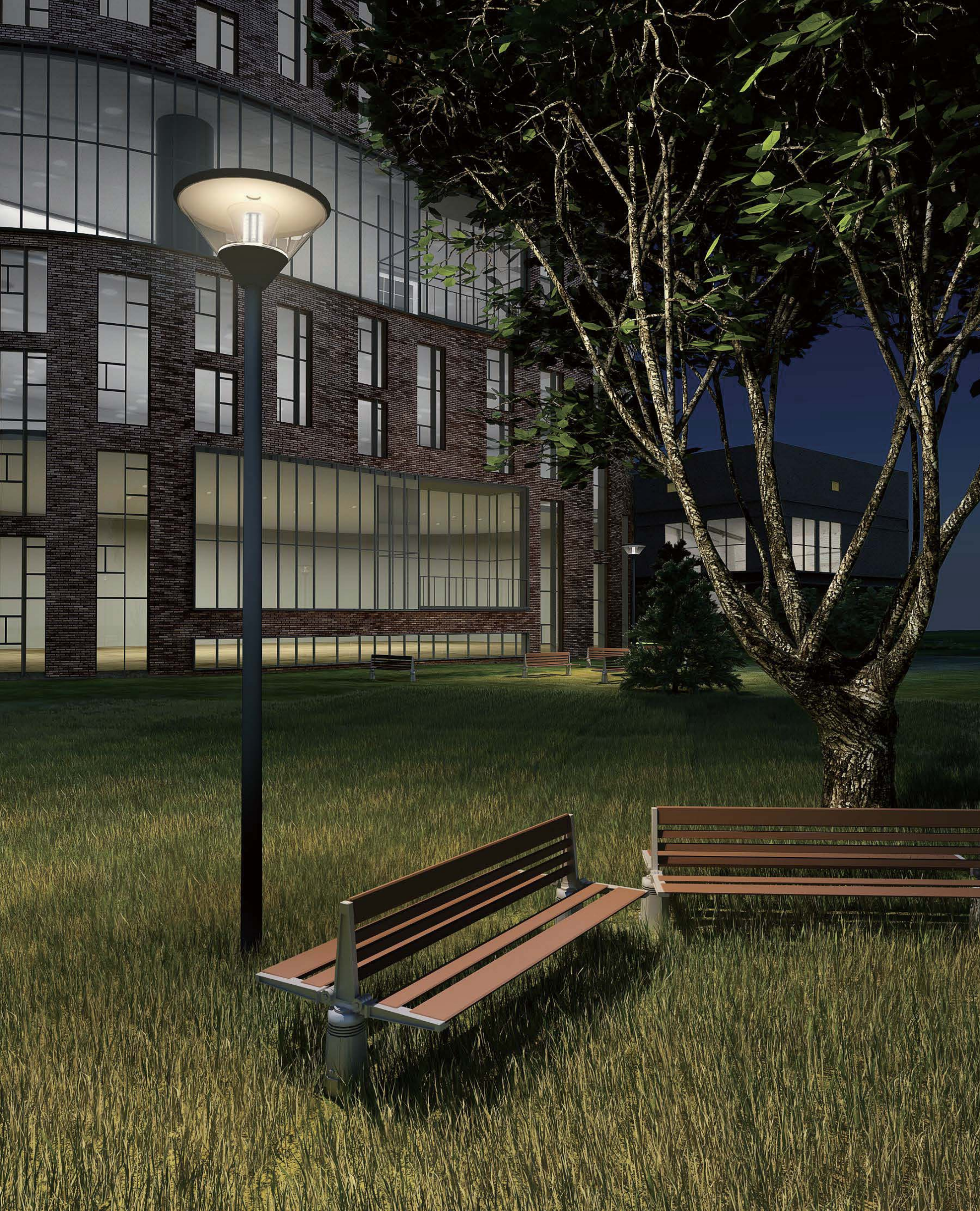

# Retrofit



■ Retrofit ..... 331-332



# Retrofit



High efficacy LED up to 150lm/w and 130lm/w for the luminaires;

Easy installation with common compatibility

The light source can be placed into below housings:



Size:(mm/inch)  
100W

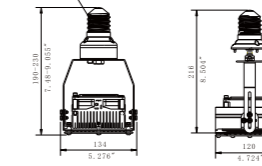
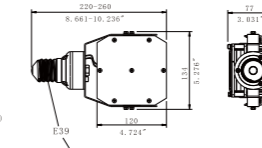
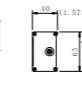
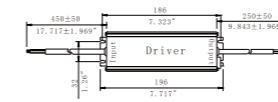

Size:(mm/inch)  
150W

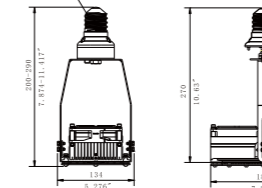
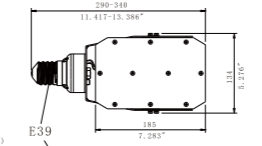
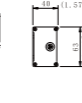
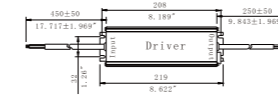

Size:(mm/inch)  
180W

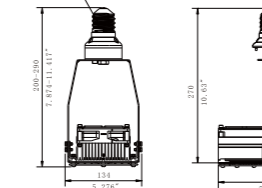
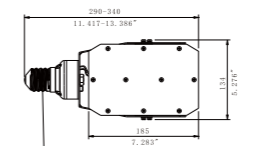
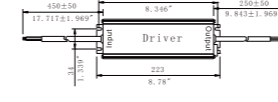

Model number	CCT	Light output (±10%)lm	CRI
RT-100-AW-W-01	5000K	12000	>80
RT-100-AW-NW-01	4000K	12000	>80
RT-100-AW-WW-01	3000K	10500	>80

Model number	CCT	Light output (±10%)lm	CRI
RT-150-AW-W-01	5000K	18000	>80
RT-150-AW-NW-01	4000K	18000	>80
RT-150-AW-WW-01	3000K	15800	>80

Model number	CCT	Light output (±10%)lm	CRI
RT-180-AW-W-01	5000 K	21600	>80
RT-180-AW-NW-01	4000 K	21600	>80
RT-180-AW-WW-01	3000 K	18900	>80

# LED Controller and Power Repeater

Signcomplex has developed hundreds of intelligent LED controllers, like RF wireless controller series, Touch panel controller series, WIFI controller series, DMX controller series, DALI controller, 0-10V/1-10V controller, power repeater, smart system.....

Signcomplex controllers can be used cooperatively with various of LED lamps, such as LED strips, LED downlight, LED outdoor lights, LED panel light or smart home control system.

**All controllers are approved by CE, ROHS, and some products are approved by FCC. We can do the OEM and ODM for customers to meet different application requirement.**



## WiFi Controller



Size (mm):

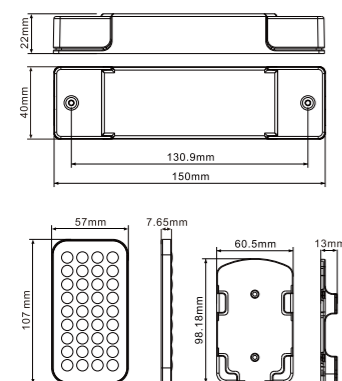

### LC-RGBW-D4-03, LC-RGBW-WiFi-02/03

#### Description:

Humanized operation interface, precise timing function, DIY setting can be realized on remote controller, ultralong remote control distance; RGB lamp, RGBW, RGB, W/WW LED strip can be controlled; the switch, mode change, bright, speed can be controlled via 2.4G remote controller or APP software.

#### Features:

1. Be suitable for IOS7.1, Android 4.0 + system;
2. Can get software of Apple and Android system free, no plug-ins;
3. Individualized interface design, humanized interface, easy to use;
4. There are single color, bi-color, RGB and RGBW correspond to dimming controller, CCT controller, RGB controller, RGBW controller respectively.

#### Technical Parameters:

Version: RF, WiFi, WiFi & RF

Input voltage: 12V-24V DC

Output channel: 4 channels

Output power: 192W(12V)-384W(24V)

Protection grade: IP20

Remote distance: 100m/30m

Color type: RGB, RGBW, RGB, W/WW LED strip

Weight: 160g each piece/ 8.36Kg the whole carton



Size (mm):

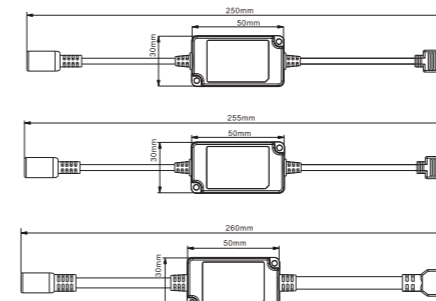

### LC-WIFI-D4-01/02/03/04/05, LC-MESH-D4-01/02/03/04/05

#### Description:

There are 10 different models of this controller series, which can all realize dimming, switching on and off, remote control, scene control and group control. Specific functions subject to actual functions of APP.

#### Features:

Core component of this product adopts high cost-effective module of Internet of Things, which enables to control 5 different LED strips, such as single color, double color (CCT), RGB, RGBW and RGBW+CW. Besides, it also supports control of Amazon and Google smart voice speaker.

#### Technical Parameters:

Input voltage: 5V-24V DC

Output channel: 5CH(max)

Output current: 2A/CH, max.6A

Output power: 72W(12V)-144W(24V)

Operating temperature: -30°C-45°C

Protection grade: IP20

Communication distance: 20 meters (under empty condition)



Size (mm):

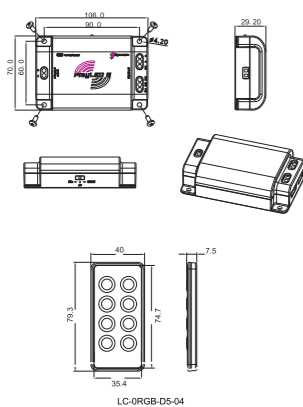

### LC-RGBW-WIFI-01

#### Description:

1. Suitable for IOS7.1, Android 4.0 + system;
2. Can acquire control software of Apple system and Android system for free, no plugin;
3. Personalized interface and humanized operation, easy to use.
4. W, WW/WW, RGB, RGBW and two LED-Controller II Setting, 6 operation interfaces in total; the first four interfaces correspond to dimming controller, color temperature controller, RGB controller, RGBW controller interface separately; two LED-Controller II Setting interfaces are used to set APP lock and ID of controller;
5. This controller has preset patterns, customized patterns and DIY patterns.
6. This controller have four functions of dimming controller, Color temperature controller, RGB controller and RGBW controller. No need for bothering purchasing various type of controller since one LC-RGBW-WIFI-01 controller can meet all your 4 demands.

#### Features:

Specially design for 5V-24V RGB LED strip and low constant voltage LED lights, self-adaptive DC 5V-24V voltage input, apply to most common RGB LED product. Used for controlling color, brightness and changing pattern via iPhone/iPod/iPad and other portable devices.

#### Technical Parameters:

Power Supply: Constant voltage power

Input Voltage: 5-24V

Output Channel: 4 channels

Channel Current: 2A/Channel, 8A in total

Output Power: 96/192W

Control Distance: 100m(in open condition)

Net Weight: 120g

Gross Weight: 150g

### LC-WIFI-D4-06/07/08/09, LC-MESH-D4-06/07/08/09

#### Description:

The controller is able to realize dimming, switching on and off, remote control, scene control and group control. Specific functions subject to actual functions of APP. The controller has on-off button. Short press the button can realize mode switch, while long press the button will restore the controller to factory default settings.

#### Features:

Core component of this product adopts high cost-effective module of Internet of Things, which enables to control 4 different LED strips, such as single color, double color (CCT), RGB and RGBW. Besides, it also supports control of Amazon and Google smart voice speaker.

#### Technical Parameters:

Input voltage: 5V-24V DC

Output channel: 4CH(max)

Output current: 2A/CH, max.6A

Output power: 72W(12V)-144W(24V)

Operating temperature: -30°C-45°C

Protection grade: IP20

Communication distance: 20 meters (under empty condition)



Size (mm):

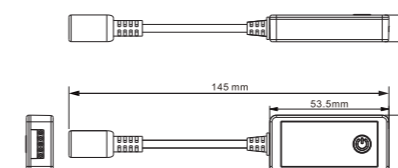

## Bluetooth Controller



Size (mm):

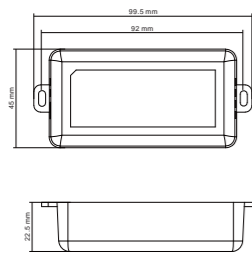

### LC-RGBW-D4-05

#### Description:

The product adopts high performance processor, humanized operating interface, precise timing function and grouping function to control single-color light bar, natural warm white light bar, RGB and RGBW light bar and other low voltage light fixtures separately. The control for color, mode and change speed may be made through Bluetooth APP with fine dimming and without flicker.

#### Technical Parameters:

Working voltage: 12-24V DC

Maximum current: 2.5A\*4CH Max.10A

Maximum power: 120W(12V)/240W(24V)

Control type: single-color, W/WW, RGB, RGBW LED strip

Remote control distance: 10 meters ( in open environment)

Working environment: indoors

Weight of controller package (gross weight): 70g

Waterproofing grade: IP20

Range of work temperature: -30 C -55 C

## RF Touchable Controller



Size (mm):

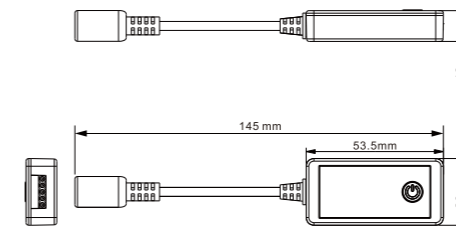

### LC-RGBW-D4-09

#### Description:

This controller is small, highly cost-effective and is able to realize group control, for controlling RGB LED strip, RGBW LED strip and other low-voltage lamps. It can control color, mode and change speed via keys on it, exquisite dimming, no flicker. The controller has an on-off key, by long pressing the key above 3s will restore the controller to factory default settings.

#### Technical Parameters:

Input voltage: 12V-24V DC

Output current: 2A/CH\*4, max.6A

Output power: 72W(12V)-144W(24V)

Control type: RGB, RGBW LED strip

Operating temperature: -30°C-45°C

Protection grade: IP20

Communication distance: 30 meters (under empty condition)



Size (mm):

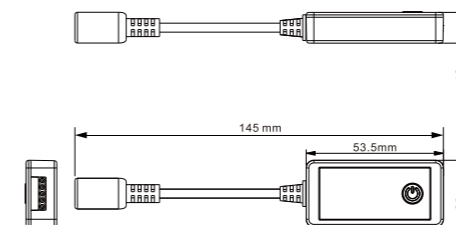

### LC-0RGB-D4-31

#### Description:

This controller is small, highly cost-effective and is able to control RGB LED strip and other low-voltage lamps. It can control color, mode and change speed via keys on it, exquisite dimming, no flicker. The controller has an on-off key, by long pressing the key above 3s will restore the controller to factory default settings.

#### Technical Parameters:

Input voltage: 12V-24V DC

Output current: 2A/CH\*3, max.6A

Output power: 72W(12V)-144W(24V)

Control type: RGB LED strip

Operating temperature: -30°C-45°C

Protection grade: IP20

Communication distance: 30 meters (under empty condition)

## RF Touchable Controller



Size (mm):

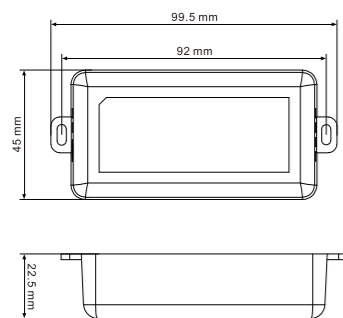

### LC-RGBW-D4-08

#### Description:

This product adopts high-performance processor which enables it to realize group control function, for controlling RGB LED strip, RGBW LED strip and other low-voltage lamps. It can control color, mode and change speed via keys on it, exquisite dimming, no flicker.

#### Technical Parameters:

Input voltage: 12V-24V DC  
 Output current: 2.5A/4CH, max.10A  
 Output power: 120W(12V)-240W(24V)  
 Control type: RGB, RGBW LED strip  
 Operating temperature: -30°C-45°C  
 Protection grade: IP20  
 Communication distance: 30 meters (under empty condition)



Size (mm):

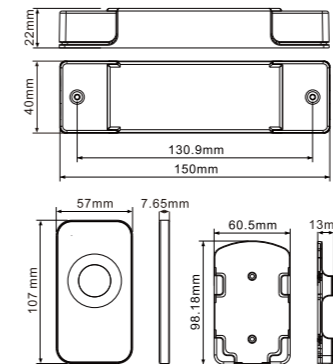

### LC-0RGB-D4-20

#### Description:

The controller adopt high performance processor, and control single color LED strip, white strip and warm white strip, RGB strip via 3 touch sliding ring remote controllers of 2.4G. User can choose color, mode and change speed via 2.4G touch sliding ring wireless grouping remote controller; exquisite dimming, no flicker. A remote controller can control multiple sets of controller, and single set controller has synchronous function, can realized synchronous effect.

#### Features:

1. Max. control distance of controller can be up to 100m (in open condition);
2. Automatic remember current change state;
3. Each remote controller can control multiple controllers.

#### Technical Parameters:

1. Working voltage: 12/24V DC;
2. Max. current: 3A\*3CH Max.9A;
3. Max. power: 108W(12V)/216W(24V);
4. Wireless transmission frequency: 2.4GHz;
5. Change mode: 52 colors (RGB);
6. Waterproof grade: IP20;
7. Working temperature range: -30°C-55°C;
8. Weight of single piece (gross weight): about 50g;



Size (mm):

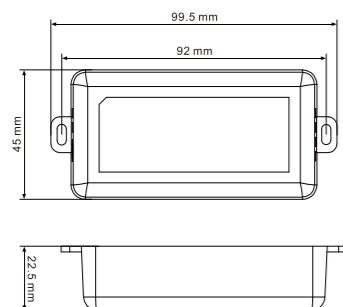

### LC-0RGB-D4-30

#### Description:

This product adopts high-performance processor and it can control RGB LED strip and other low-voltage lamps. Besides, it can control color, mode and change speed via keys on it, exquisite dimming, no flicker.

#### Technical Parameters:

Input voltage: 12V-24V DC  
 Output current: 3A/3CH, max.9A  
 Output power: 108W(12V)-216W(24V)  
 Control type: RGB LED strip  
 Operating temperature: -30°C-45°C  
 Protection grade: IP20  
 Communication distance: 30 meters (under empty condition)

## RF Touchable Controller



Size (mm):

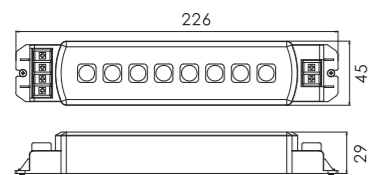

### WC11-C

#### Function Descriptions:

1. This product is designed to control low voltage RGB LED luminaires. It has 16 pre-positioned changing patterns. It features the unique touch interface technology with the function keys. User does not need to have even small pressure on the keys to create dynamic color patterns.
2. This user-oriented controller can make automatic recognition of 12V or 24V DC when it works with LED products, that means it is compatible with 12V DC and 24V DC. So it can be used for most RGB LED products in the market.
3. With PWM built in MCU, it can realize even and smooth dimming without flash thanks to the power MOS, the total driven current of the 3 channels can be up to 18A.

#### Features:

1. Touch function;
2. 12/24V DC;
3. 16 color patterns;
4. 20 levels for brightness adjustment;
5. Memory function;
6. Smooth dimming without flash.

#### Technical Parameters:

Input voltage: 12V-24V DC  
 Output current: 6A/3CH  
 Output power: 216W(12V)/432W(24V)  
 Channels: RGB 3 channels  
 Control distance: >30m  
 Weight: 126g  
 Accessories: controller, User manual

### LC-0RGB-D5-01-C

#### Function Description:

The LC-0RGB-D5-01 waterproof controller is designed for normal RGB LED strips and low voltage RGB LED luminaires. It has 16 prepositioned patterns. The controller is easy to use by the unique touch interface technology and the humanized design. Not only the touch interface but also a paired wireless remote control within the distance of 30m can be used. With the learning function, it applies to the same model remote control in different encoding addresses. The controller is compatible with 12V DC and 24V DC, so it can be used for most RGB LED products in the market. Besides, the controller set a MCU internal PWM dimming hardware to achieve flicker-less dimming. High-power MOS drive, The total current of RGB 3 channels is 18A.

#### Features:

1. 16 color patterns, for example, seven colors static (individually adjustable), jump, and gradual change (with pausing function);
2. 20 levels of brightness adjustment;
3. 20 levels of speed regulation.

#### Technical Parameters:

Input voltage: 12V-24V DC  
 Output current: 6A\*3CH  
 Output power: 216W(12V)/432W(24V)  
 Control distance: >30m  
 Waterproof: IP65  
 Weight: 201g  
 Accessories: controller, User manual

Size (mm):

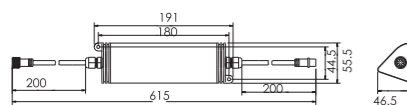

## RF Standard Controller

### SC-WC6-V1

#### Function Descriptions:

The controller adopt high performance processor, and control RGB outdoor luminaires via 2.4 G wireless remote controller. User can choose color, mode and change speed via 2.4G remote controller; and the controller can switch between 52 colors, and it can pause during dimming. The controller has synchronous function, the color effect between multiple units can be synchronous.

#### Technical Parameters:

1. Working voltage: 12/24V DC;
2. Max. current: 18A in total;
3. Control color type: RGB;
4. Wireless transmission frequency :2.4G;
5. Receiving sensitivity : -96dBm;
6. Transmitting power: 6dBm;
7. Control distance: 70m
8. Color mode: 52 colors;
9. Waterproof grade: IP65;
10. Working temperature range: -20 C-70 C;



Size (mm):

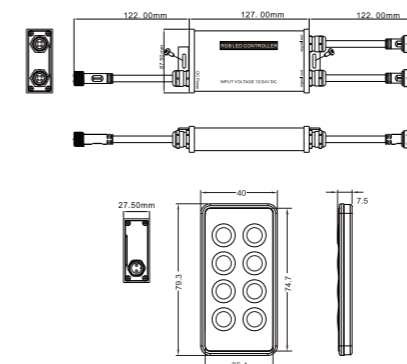

Size (mm):

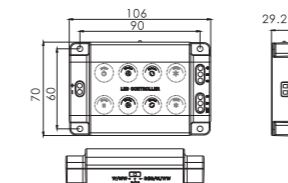

### LC-0RGB-D4-01

#### Function Descriptions:

1. 86 color modes;
2. Adjust color under the static mode;
3. Jump, fade in and out (with pause function);
4. Switch with three function modes: The first one control 5 channels Output (R,G,B,W,WW) for four or five colors LED products. The second one can control 3 channels output (R,G,B), for three colors LED product, and the third one can control 2 channels output (W,WW), for single color LED product or that with two colors. (note: four color LED product would be RGB+W or RGB+WW, five colors LED product would be RGB+W+WW, and three colors LED products would be RGB).

#### Features:

1. 5 channels (R, G, B, W, WW);
2. 12/24V DC;
3. 86 color patterns;
4. 20 levels for brightness adjustment;
5. Memory function;
6. Smooth dimming without flash.

#### Technical Parameters:

Input voltage: 12V-24V DC  
 Output current: 4A\*5CH  
 Output power: 240W(12V)/480W(24V)  
 Channels: RGB/W/WW 5 channels  
 Control distance: >30m  
 Weight: 116g  
 Accessories: controller, 8 key remote pad, User manual

## RF Standard Controller



Size: ( mm )

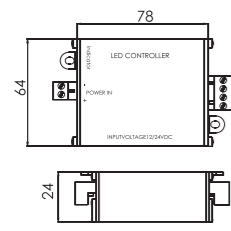

### SC-WC7

#### Features:

#### 2.4GHZ WC7

Compatible with all common RGB strips and low voltage RGB lamps, Built-in 32 modes and can be controlled by a small key board. Automatically adapt to LED light which works at DC12V or DC24V. Hardware PWM dimmer without any flashes. High-power MOS driver, the whole current of the RGB three channels reaches to 18A.

#### SC-WC7-V2

1. 16 changing patterns including jump and smooth;
2. Wireless control;
3. Power-off data protection;
4. Working with power amplifier to expand power output unlimitedly.

#### SC-WC7-V3

1. Used for of 24V/12V single color strip, built-in dimming and gradient modes;
2. Can choose the modes and dimming with remote controller.

#### SC-WC7-V4

1. Used for of 24V/12V single color strip.
2. With Adjust light remote controller.

#### Technical Parameters:

Input voltage: 12V-24V DC  
Output current: 6A\*3CH  
Output power: 216W(12V)/432W(24V)  
Channels: RGB 3 channels  
Control distance: >30m  
Weight: 106g

### LC-0RGB-D4-16

#### Description:

The controller adopt high performance processor, and control RGB LED strip, RGB luminaires via 2.4 G wireless remote controller. User can choose color, mode and change speed via 2.4G remote controller. The controller features dimming, pause when change, dimmable and other functions (52 color modes, touch slide ring control), and it also has synchronizing function, the color effect between multiple units can be synchronous.

#### Technical Parameters:

Input voltage: 12V-24V DC  
Color mode: 52  
Waterproof grade: IP20  
Weight: 105g

### LC-0RGB-D4-19

#### Function Description:

The MINI multicolor LED controller is suitable for RGB multicolor LED strip. Via the controller, color change effect can be controlled; pixel quantity. can be set; speed and brightness can be adjusted.

#### Technical Parameters:

Input voltage: 5V-24V DC  
Color mode: 60  
Waterproof grade: IP20  
Weight: 105g

### 433 wireless MINI dimming controller

#### Description:

The product adopts high performance processor and may be provided with three different types of remote controller according to different requirements to control single-color light bar, white/warm white light bar, RGB light bar and other low voltage lamps. The control over color, mode and speed change can be implemented through all types of functional keys on the remote controllers. Fine dimming without flickering.

#### Technical Parameters:

Work voltage: 12/24V DC  
Maximum current: 2A\*3CH, Max.6  
Maximum power: 72W (12V)/144W (24V)  
Control type: single-color, W/WW, RGB led strip  
Wireless receiving/transmitting frequency: 433MHz  
Remote control distance: 20 meters (in open environment)  
Waterproofing grade: IP20  
Range of work temperature: -30 C-55 C



Size (mm):

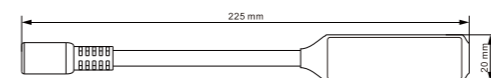

Size (mm):

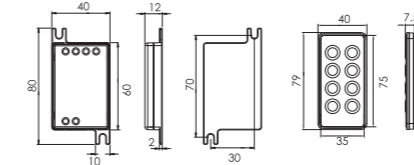

### LC-0RGB-D5-06

#### Features:

Compatible with all common RGB strips and low voltage RGB lamps. Built-in 16 modes and can be controlled by a small key board. Automatically adapt to LED light which works at DC12V or DC24V. Hardware PWM dimmer without any flashes. High-power MOS driver, the whole current of the RGB three channels reaches 9A.

#### Technical Parameters:

Input voltage: 12V-24V DC  
Output current: 3A\*3CH  
Output power: 108W(12V)/216W(24V)  
Channels: RGB 3 channels  
Control distance: >30m  
Weight: 22g

## LED Power Repeater



Size (mm):

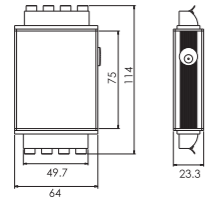

### LA-RGB-D5-01

#### Description:

LED amplifier adapt to all of our LED strips, luminaries or any other luminaries similar with ours. Using an amplifier on every degree for connecting more RGB luminaries, In theory, one controller could connect innumerable amplifiers.

#### Technical Parameters:

Input voltage: 12V/24V DC  
Output current: 3A/channel  
Output power: 108W(12V)/216W(24V)  
Channels: RGB 3 channels  
Weight: 106g



Size (mm):

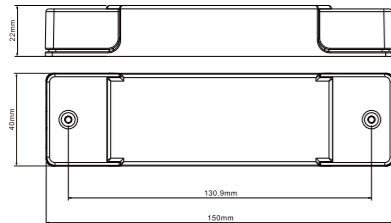

### LA-RGBW-D4-02

#### Description:

The signal amplifier is applicable to 4-in-1 RGBW controller. When one amplifier is connected, it can bear more ordinary RGB+W+WW LED strips and low voltage RGB+W+WW LED luminaires, and the specific length is according to power of signal amplifier and serial connection limit of LED strip and luminaire;theoretically, Maximum 10 grades signal amplifier can be connected in serial, and multiple amplifier can be connected in parallel on each grade.

#### Technical Parameters:

Input voltage : 12V/24V DC  
Output channels: RGBW 4 channels output  
Output current: 3A for each channel  
Output power: 144W (12V input)/288W (24V input)  
Waterproof level: IP20  
Weight(gross weight): about 80 gram



Size (mm):

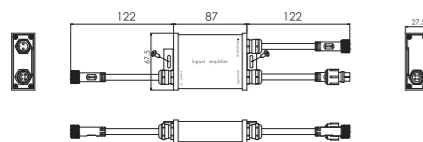

### SC-AP-W-12/24

#### Description:

1.LED amplifier can run all our RGB waterproof lights. Its input channel can be controlled by 3 channels of PWM. Connected with an amplifier, more RGB lights can be controlled. In theory, numberless amplifiers can be connected after one controller.  
2.Relay amplifier could amplify the weakened signal,and the original signal remain the same all along.

#### Technical Parameters:

Input voltage : 12V/24V DC  
Output current: 5A\*3CH  
Output power: 180W (12V)/360W (24V)  
Waterproof level: IP65  
Weight: 168g

## DMX Controller



Size (mm):

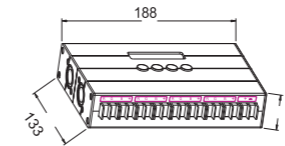

### SC-WC8 (2.4GHz version)

#### Features:

- 1.Meet DMX512(1990) protocol. Can be used as a DMX512 decoder;
- 2.A LCD screen show controller's current working status;
- 3.33 normal changing patterns and 4 DMX operating modes;
- 4.256 levels brightness, totally 16.77 million colors, real full color (up to 65536 levels);
- 5.0-255 changing speed levels for dynamic change;
- 6.RGB individual dimming function;
- 7.Automatic parameter memory;
- 8.XLR3 Male and Female interface.

#### Technical Parameters:

Input voltage : 12V/24V DC  
Output power: 720W  
Control distance: >30m  
Weight: 570g



Size (mm):

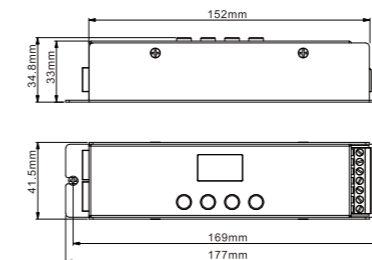

### LC-0DMX-D4-21

#### Description:

Can be used as DMX512 decoder, and apply to DMX512(1990) protocol. OLED can display current operating state,convenient to operate; buttons of controller panel can control corresponding channel to change light tracing mode, light tracing speed, type and length of LED strip.

#### Features:

1. DMX control
2. Data save automatically after power down
3. Visual operation, flexible and convenient;
4. 60 common change modes and 2 DMX decoding modes;
5. 0-255 grades speed adjustment in dynamic mode;
6. 256 grades brightness for each channel, 16581375 colors in total;
7. RJ45 standard ethernet interface.

#### Technical Parameters:

Working voltage: 5-36V DC  
Max.current: 9A  
Max.power: 45W/108W/216W/324W(5V/12V/24V/36V)  
Control type: RGB SPI LED strip  
Waterproof Level: IP20  
Operating temperature range: -30 C -55 C



## DMX Controller



Size (mm):

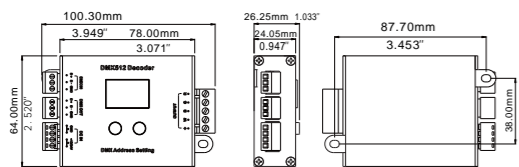

### LC-0DMX-D4-06-D

#### Description:

Applied to 12V/24V RGB,RBBW,WW+W,W strips or lamps, four output channels at most.the controller works as DMX512 decoder.

#### Technical Parameters:

Input voltage : 12V-24V DC

Output power: 108W (12V)/216W (24V)

Waterproof level: IP40

Weight: 130/220g

### LC-0DMX-D4-17

#### Description:

Can be used as DMX512 decoder, and DMX512(1990) protocol applies. OLED can display current operating state,convenient to operate; buttons of controller panel can control mode, change speed, brightness of corresponding channel.

#### Technical Parameters:

Input voltage : 12V-24V DC

Color mode: 35

Waterproof level: IP20

Weight: 320g

Size (mm):

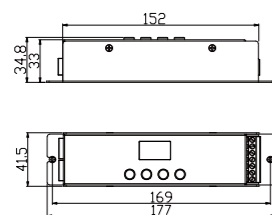

## Infrared Remote Controller

### LC-0RGB-D2-02

#### Features:

24 keys IR controller is with multiple functions, adopt advanced MCU control, used for LEDs luminaires ; the controller has 20 modes to choose, low cost,easy wiring, convenient to use; via IR controller,LED lights can be changed the mode,adjusted the speed and brightness,chosen the static colour various dynamic light change effect can be realized.

#### Technical Parameters:

Input voltage : 5-12V DC

Output power: 72W

Control distance: >30m

Weight: 570g



Size (mm):

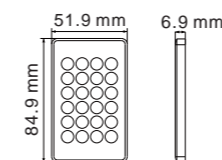
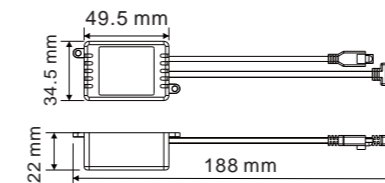

### LC-0RGB-D2-03

#### Features:

24 keys Bluetooth IR controller could work with IR remote & smart phone, basic on Bluetooth MESH technology , you can control all the receiver at the same time, there is wireless Synchronization technology, that could make all the dynamic mode change together all the time.

#### Technical Parameters:

Input voltage : 12-24V DC

Output power: 72W

Control distance: >30m

Weight:70g



Size (mm):

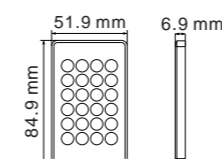
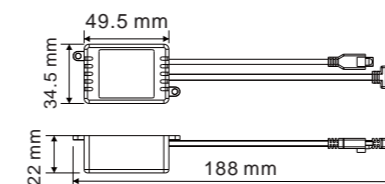

# Aluminum Bar



SC-ALH-01AS



Sectional Dimensions (mm)

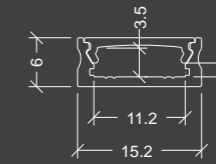

- length ▾
  - 520mm(standard)
  - 1020mm(standard)
  - 2000mm(standard)
  - 3000mm(standard)
  - (customized length is available, please contact our sales for detailed information)

- surface finish ▾
  - 6063Aluminum
  - Silver oxidation

SC-ALH-02AS



Sectional Dimensions (mm)

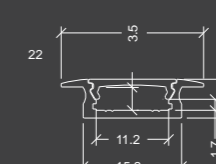

- Cover ▾
  - transparent
  - frosted
  - opal

- Accessories ▾
  - end cap
  - clip
  - screw

SC-ALH-03AS



Sectional Dimensions (mm)

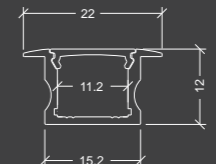

SC-ALH-04AS



Sectional Dimensions (mm)

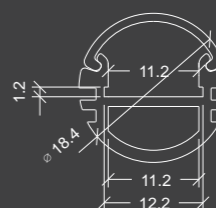

SC-ALH-01BS



Sectional Dimensions (mm)

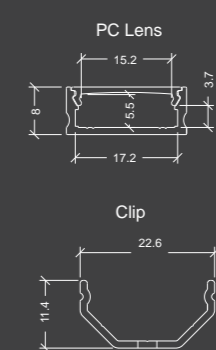

# Aluminum Bar

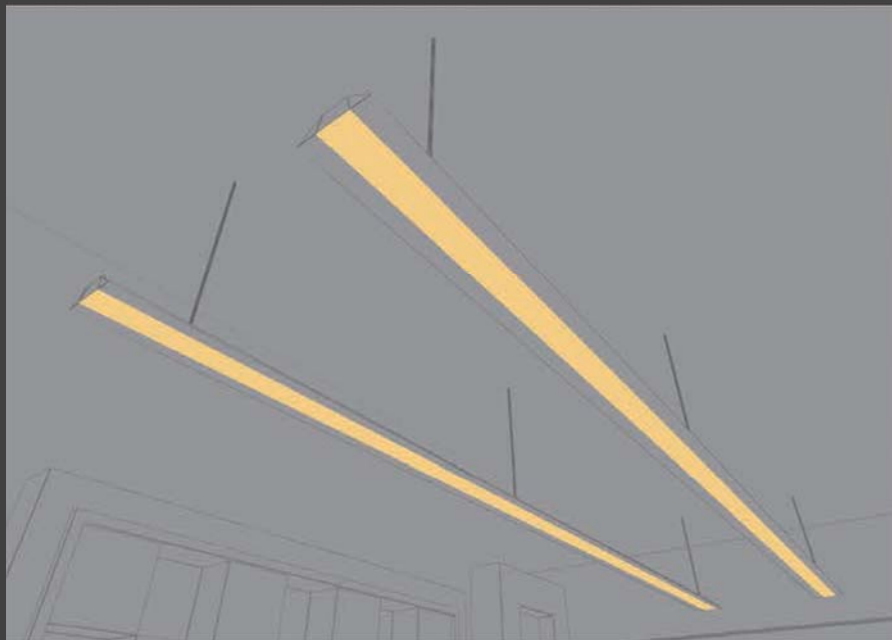
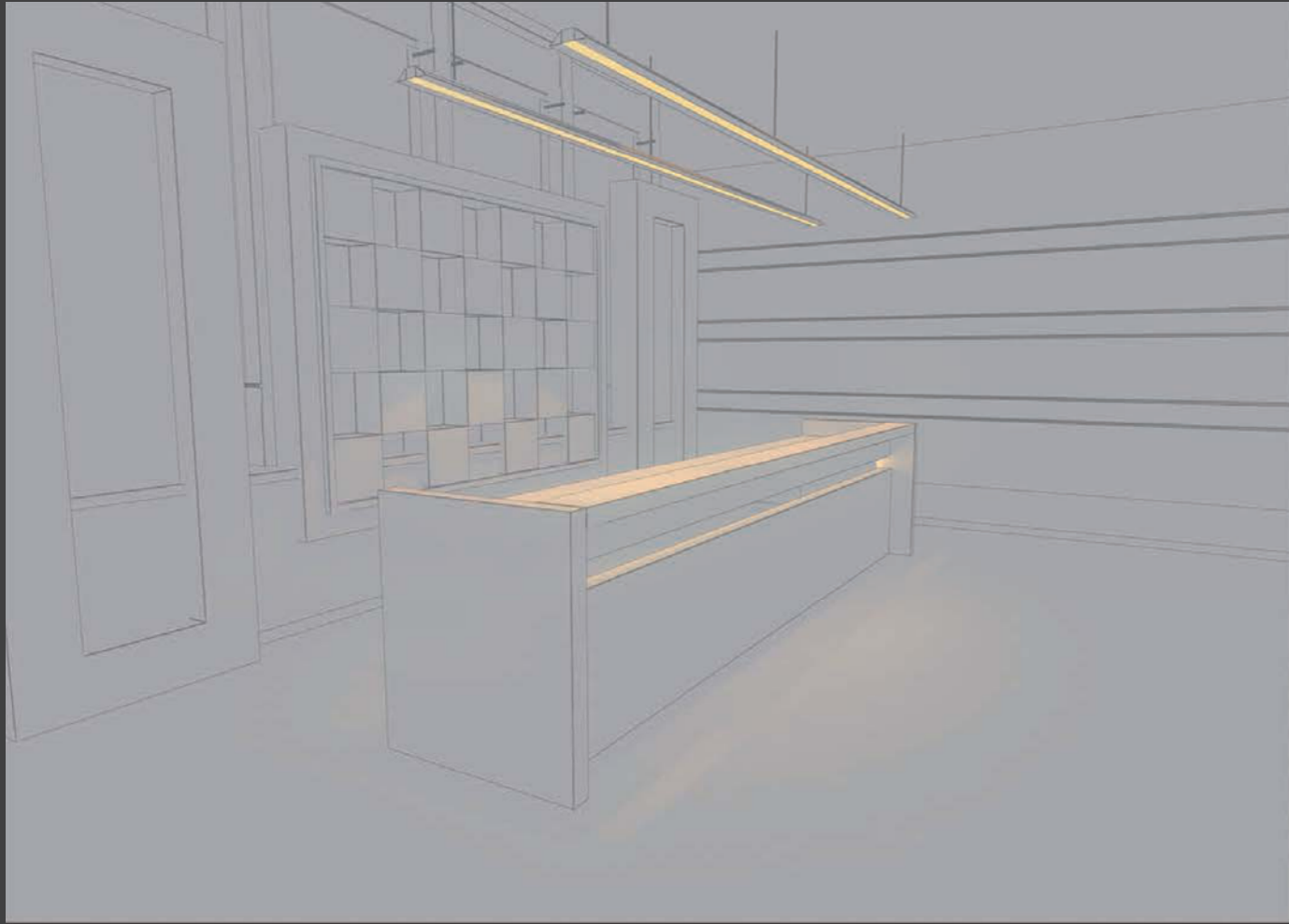

# Aluminum Bar

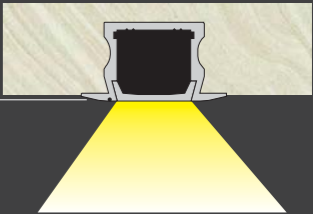
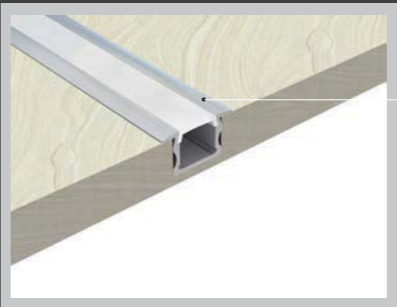

There are curves on the edges of aluminum profile, which are not only for covering the edges, but also for beautiful appearance and impact resistance.

### Installation method of LED strip.(Take SC-ALH-04S for example)



1.Paste adhesive LED strip into the aluminum profile.



2.Take out the power cord through the hole on the end cap.

3.Put the end cap onto the profile and press gently to fix it.

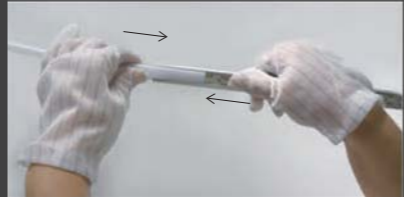

4.Install the cover from the other side and then install the other end cap.

## Limited Warranty

The “Warranty Period” will begin at the date of original Product purchase from either Signcomplex , or an authorized Signcomplex Distributor/Dealer. Signcomplex will repair or replace product covered under this warranty with components at Signcomplex’s election or discretion. Advances in technology may lead to “better or advanced” products being selected for replacement.

This Warranty is further conditioned on the purchaser contacting Signcomplex during the warranty period between normal business hours to review the issue and initiate the Returned Merchandise Authorization (RMA) process. This must be done prior to the return of any defective product. Only Signcomplex manufactured products may be returned through the Signcomplex RMA process. No defective products, Signcomplex or otherwise, will be returned to purchaser. The Signcomplex RMA form must be legible and completed in detail prior to approval for return. The Signcomplex Warranty is further conditioned and will only apply to Signcomplex products that are properly installed. This includes wiring and connection to proper approved components and product working environments. This Warranty is void and does not apply to products that fail as a result of neglect, mistake, misuse, alteration, improper installation or implementation. This includes but is not limited to: improper wiring, installation under improper and nonapproved operating environments such as temperature, humidity or voltage conditions; improper ins-tallation using components that are not approved or are not Signcomplex manufactured products.

Installation and usage of Signcomplex products should only be completed in association and complete knowledge of all necessary and related codes, standards and instructions of installation. It is the responsibility of the purchaser to obtain all necessary approvals and to understand the product’s intended use and all relevant instructions, recommendations, and guidelines for the proper installation, use of any Signcomplex product and related “manufactured products,” used in conjunction with . The accuracy and completeness of any statements, technical information and recommendations in any form of product literature or instructions are not guaranteed, are not part of this Warranty, and does not in any way constitute a warranty. The purchaser is responsible for suitability of installation and full implementation and must determine potential applications and installations independently.

Warranty Compensation will be based on “usage factors and time in use” and “Technology Value,” and will be prorated based on this and information collected via the RMA process.

## Product Warranty Matrix

Flexible LED strip	3years	LED corn bulb	5years
Rigid LED light bar	3years	Retrofit	5years
LED downlight	3years	LED tube	5years
Emergency light	3years	LED highbay light	5years
LED panel light	3years	Tri-proof led lamp	5years
LED linear light	3years	LED controller	5years
PL lamp	3years	LED flood light	5years
Table light	3years	Wall pack	5years
Track light	3years	Shoebox	5years

What is not covered under this Limited Warranty is defects of any kind caused or created by improper installation of any kind; damage caused during shipping to purchaser or beyond “acts of Nature or God.” Signcomplex will not cover additional labor costs or Warranty such labor associated with replacement products. This Warranty document represents the only ex-press or implied Warranty – no other Warranties exist.

## Certificates



