



**COMPLIES COMPLETELY WITH  
RDSO SPECS NO.  
TI / SPC / OHE / TIPS / 1031 (Dec 2013)**

## **DT-9885 Performance Thermal Imager**

DT-9885 is High Performance Thermal Imager with high resolution 384x288, help you to find the potential problems with innovation features and functionality, you can perform infrared inspections faster and more efficiently and thoroughly document problem areas for additional information.



### **KEY FEATURES**

- 384x288 High Performance & high resolution Thermal Imager with TFT color LCD display
- Professional IR-optical focus system ensures that images are in good focus for optimum image clarity and scanning convenience
- Thermview analysis system—quickly identify and keep track of inspection locations by adding digital images of important information and surrounding areas
- Finds problems faster and easier by accurately identifying potential issues by combining digital and IR images
- Picture in Picture function Displays Thermal Image super-imposed over a digital image
- LED Flashlight allows the visual camera and fusion to be used in poorly lit environments
- Wide Temperature Range from -20 to +500°C targeting electrical and industrial applications
- ±2% Accuracy for reliable temperature measurement
- The image rotation facility allows to automatically rotate the active image
- Audio recording with the video image acts as a speaker to listen to audio recorded with the video image
- Capacitive touch screen is easier, productive and efficient to operate it
- Lithium polymer Rechargeable Battery lasts > 4hrs continuous use; and is replaceable
- An easy-to-access thumbnail image gallery helps you to quickly review and find your thermal images.
- Area (Min/Max) mode shows the Minimum or the Maximum Temperature reading in the selected area
- A conveniently located button activates the laser pointer that will help you associate the hot or cold spot in the thermal image with the real physical target in the field.
- In order to adapt the device to every situation both wide angle and tele-lenses are available.
- Equipped with standard video, USB outputs as well as a removable SD card.

## SPECIFICATIONS

Imaging And Optical Data	
<b>IR Resolution</b>	384 x 288 pixels, Focal Plane Array (FPA), Uncooled Microbolometer
<b>Field of View (FOV)</b>	24.6° x 18.6°
<b>Minimum focus Distance</b>	0.3m (0.99ft.)
<b>Spatial Resolution</b>	(IFOV) 1.14mrad
<b>Thermal Sensitivity / NETD</b>	< 0.05°C @ +30°C (+86°F) / 50 mK
<b>Image Frequency</b>	50Hz
<b>Focus mode</b>	Manual
<b>Zoom</b>	1-20x Continuous, Digital Zoom
<b>Rotate</b>	0° - 360°, Continuous Change by 1°
Image Presentation	
<b>Display</b>	3.5" TFT, Capacitive Touch Screen
<b>Image modes</b>	IR Image, Visual Image, Picture in Picture
<b>Picture in Picture</b>	IR Area on Visual Image or Visual Image Area on IR
<b>Color Palettes</b>	IRON / RAINBOW / GREY / GREY INVERTED / SEPIA / BLUE-RED / HOT-COLD / FEATHER
Measurement	
<b>Object Temperature Range</b>	Low Range -20°C to + 150°C (-4°F to + 302°F) High Range 0°C to + 500°C (+32°F to + 932°F)
<b>Accuracy</b>	±2°C (±3.6°F) or ±2% of Reading
Measurement Analysis	
<b>Spotmeter</b>	3
<b>Emissivity Adjustable</b>	0.01 ~ 1.0 Adjustable
<b>Emissivity Table</b>	Emissivity Table of Predefined Materials
<b>Line</b>	2 lines (Horizontal and Vertical)
<b>Area</b>	3 Boxes with max. / min. / Average
<b>Automatic Hot / Cold Detection</b>	Auto Hot or Cold Spotmeter Markers
<b>Isotherm</b>	Detect High / Low Temperature / Interval
<b>Difference Temperature</b>	Delta Temperature Between Measurement Pointer and Reference Pointer
<b>Measurement corrections</b>	Emissivity, Ambient Temperature, Distance, Relative Humidity, Offset Temperature
Set-Up	
<b>Laser / Flood light</b>	< class2 / white LED Floodlight
<b>Set-up Commands</b>	Local Adaptation of Units, Language, Date and Time Formats, Information of Camera
<b>Languages</b>	English, Chinese, French, German, Spanish
Storage Of Videos	
<b>Storage Media</b>	4 Gbytes Micro SD Card
<b>Video Storage format</b>	Standard MPEG-4, 640x480@30fps, on Memory Card > 60 Minutes
<b>Video Storage Mode</b>	IR / Visual Images; Simultaneous Storage of IR and Visual Images
Storage Of Images	
<b>Image Storage Format</b>	Standard JPEG, Including Measurement Data, on Memory Card > 1000 Pictures
<b>Image Storage Mode</b>	IR / Visual Images; Simultaneous Storage of IR and Visual Images

## SPECIFICATIONS

Annotations	
<b>Text Annotations</b>	User defined text annotations with each image using onscreen keyboard
<b>Voice Annotations</b>	Users can record upto 60 seconds of voice tag along with each image
Digital Camera	
<b>Built-in Visible Light Digital Camera</b>	2 Mega pixels
Data Communication Interfaces	
<b>USB Interfaces</b>	USB-mini, data transform between camera and PC
<b>Video Out</b>	Composite (PAL and NTSC)
Power System	
<b>Battery</b>	Lithium polymer battery, 4 hours operating time
<b>Input Voltage</b>	DC 9V to 12V
<b>Charging System</b>	In camera (AC adapter)
<b>Power Management</b>	Automatic shutdown and sleep mode (user selectable)
Environmental Data	
<b>Operating Temperature Range</b>	-20°C to + 50°C (-4°F to + 122°F)
<b>Storage Temperature Range</b>	-40°C to + 70°C (-40°F to + 158°F)
<b>Relative Humidity (operating and storage)</b>	0% to 90% non condensing
<b>Encapsulation</b>	IP65
<b>Drop test</b>	2m
<b>Bump</b>	25g (IEC60068-2-29)
<b>Vibration</b>	2g (IEC60068-2-6)
<b>Size (H x W x D)</b>	243mm x 103mm x 160mm
<b>Weight</b>	920g

## APPLICATIONS

HVAC/R  
 Transportation / Automotive  
 Cooling and Reheating  
 Serving Areas  
 Food Service Equipment  
 Cold Storage

## INCLUDED ACCESSORIES:

Hard Transport Case, 22mm Lens, Sun Visor, Tripod Base, AC Charger / Power Supply, Earphone, Battery, Camera Lens Cap, Software CD-ROM, Handstrap, Micro SD Card, USB Cable & RCA Cable, Gift Box.

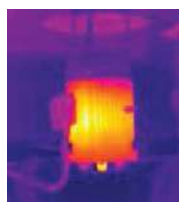

Interchangeable  
Lens

3.5"

Image

Touch

# Thermal Imager

## User Manual

Illuminating Light

Image Fusion

USB

Video

micro  
SD



Interchangeable  
Lens

Touch

Image Fusion

USB

Image

micro  
SD

Video

Illuminating Light

LASER



Please read this manual before switching the unit on.  
Important safety information inside.



<b>Contents</b>	<b>Page</b>
1-Introduction.....	4
2-Safety Information.....	4
3-Packing Lists.....	5
3.1-Standard Accessories.....	5
3.2-Optional Accessories.....	5
4-Specifications.....	6
5-Structure Description.....	8
5.1-Back View.....	8
5.2-Front View.....	8
5.3-Assembly Drawing.....	9
5.4-Interface.....	9
6-Before You Start.....	10
6.1-How to Charge the Battery.....	10
6.1.1-Battery Charger Base.....	10
6.1.2-AC Power Socket.....	10
6.2-Power On and Off.....	10
6.3-Main Interface.....	11
6.4-Optical Lens.....	11
6.5-Focus.....	12
6.6-Shutter.....	12
6.7-Temperature Measurement.....	13
6.8-Emissivity Adjustment.....	13
6.9-Reflected Temperature.....	14
6.10-Thermal Imager Reporter Software.....	14
7-Menus.....	14
7.1-Main Menu.....	14
7.2-Image Menu.....	15
7.2.1-Image Mode.....	15
7.2.2-Image Palette.....	16
7.2.3-Image Adjustment.....	18
7.2.4-Image Setting.....	19
7.2.5-Zoom and Rotation.....	20
7.3-Measurement Menu.....	20
7.3.1-Point Measurement.....	20
7.3.2-Line Measurement.....	21
7.3.3-Area measurement.....	22
7.3.4-Measurement Settings.....	23
7.4-Camera Menu.....	25
7.4.1-Snapshot Menu.....	26
7.5-Video Menu.....	27
7.6-Photos Browser.....	27
7.6.1-Multi-Photos Browser.....	27
7.6.2-Single-Photos Browser.....	28
7.7-Player Menu.....	28
7.8-Settings Menu.....	29
7.8.1-General Page.....	29
7.8.2-Control Page.....	31
7.8.3-Photos Page.....	32
7.8.4-Date & Time Page.....	32
7.8.5-Info Page.....	33
7.9-Factory Settings.....	33
8-Fault diagnosis and exclusion.....	34

## 1-Introduction

### Overview

The Thermal Imager is handheld imaging camera used for predictive maintenance, equipment troubleshooting, and verification. Thermal and visual images are displayed on the LCD and can be saved to a MicroSD Memory card. Transferring images to a PC is accomplished by removing the SD memory card and connecting it to a PC through the included card reader.

In addition to the features mentioned above, the Thermal Imager provide video recording with audio and play back.

## 2-Safety Information

To prevent eye damage and personal injury, do not look into the laser. Do not point laser directly at persons or animals or indirectly off reflective surfaces.

Do not disassemble or do a modification to the Thermal Imager.

Do not point the Thermal Imager (with or without the lens cover) at intensive energy sources, for example devices that emit laser radiation, or the sun.

This can have an unwanted effect on the accuracy of the camera. It can also cause damage to the detector in the Thermal Imager.

Do not use the Thermal Imager in a temperature higher than +50°C (+122°F), lower than -20°C (-4°F). High temperature or low temperature can cause damage to the Thermal Imager.

Only use the correct equipment to discharge the battery.

If you do not use the correct equipment, you can decrease the performance or the life cycle of the battery. If you do not use the correct equipment, an incorrect flow of current to the battery can occur. This can cause the battery to become hot, or cause an explosion and injury to persons.

Do not disassemble or do a modification to the battery.

The battery contains safety and protection devices which, if they become damaged, can cause the battery to become hot, or cause an explosion or an ignition. If there is a leak from the battery and the fluid gets into your eyes, do not rub your eyes. Flush well with water and immediately get medical care.

Do not make holes in the battery with objects. Do not hit the battery with a hammer. Do not step on the battery, or apply strong impacts or shocks to it.

Do not put the battery in or near a fire, or in direct sunlight, or other high-temperature locations. Do not solder directly onto the battery.

Always charge the battery in the special temperature rang.

The temperature range through which you can charge the battery is 0°C to +50°C(+32°F to +122°F). If you charge the battery at temperatures out of this range, it can cause the battery to become hot or to break. It can also decrease the performance or the life cycle of the battery.

Do not get water or salt water on the battery, or permit the battery to get wet.

Clean the case with a damp cloth and a weak soap solution. Do not use abrasives, isopropyl alcohol, or solvents to clean the case or lens/screen.

Be careful when you clean the infrared lens. Do not clean the infrared lens too vigorously. This can damage the anti-reflective coating.

#### Avoid condensation

Take the Thermal Imager from cold to hot, it will appear condensation in thermal Imager. To protect the Thermal Imager, you should power of the Thermal Imager, wait until the Thermal Imager has become warm enough for the condensation to evaporate.

#### Storage

If you do not use the Thermal Imager, remove the battery from the Thermal Imager, and put the Thermal Imager in cool and dry environment, if you store Thermal Imager equipped with the battery, the power of the battery will be exhausted.

## 3-Packing Lists

### 3.1-Standard Accessories

Item	Quantity	Description
Thermal Imager	1	
Lens	1	Field of view=24.6° x 18.6°, f=22mm
Lens Cover	1	
Lcd Hood	1	
Tripod Base	1	
Lithium polymer battery	1	7.4V, 2600mAH
Adaptor	1	Input AC Volts: 100V~240V, 50/60Hz, MAX 0.8A Output DC Volts: 12V, 3000mA
Charger	1	
Micro SD	1	4Gbyte
USB cable	1	
RCA cable	1	
Earphone	1	
User manual	1	
Warranty Card	1	
PC software	1	
Installation CD		
Gift box & Carrying case	1	

### 3.2-Optional Accessories

Item	Quantity	Description
Lens	1	field of view = 47.1°x 36.2°, f = 11mm
Lens	1	field of view = 13°x 9.8°, f = 44mm
Lithium polymer battery	1	7.4V, 2600mAH

#### 4-Specifications

<b>Imaging And Optical Data</b>	
Field of view (FOV) / Minimum focus distance	24.6°x 18.6°/ 0.3m
Spatial resolution (IFOV)	1.14mrad
Thermal sensitivity/NETD	< 0.06°C @ +30°C (+86°F) / 60 mK
Image frequency	50Hz
Focus mode	Manual
Zoom	1–20× continuous, digital zoom
Rotate	0°– 360°, continuous increased by 1°
Focal length	22mm
Focal Plane Array (FPA) / Spectral range	Uncooled microbolometer / 8–14 μm
IR resolution	384 × 288 pixels
<b>Image Presentation</b>	
Display	Capacitive Touch screen, 3.5 in. LCD, 320 × 240 pixels
Image modes	IR image, visual image, picture in picture, Image Fusion
Picture in Picture	IR area on visual image or visual image area on IR
Color palettes	IRON/Rainbow/Grey/GreyInverted/Sepia/Blue_Red /Hot_Cold/Humidity
<b>Measurement</b>	
Object temperature range	–20°C to +150°C (–4°F to +302°F) 0°C to +400°C (+32°F to +752°F)
Accuracy	±2°C (±3.6°F) or ±2% of reading
<b>Measurement Analysis</b>	
Spot	3
Line	2 lines(horizontal and vertical)
Area	3 boxes with max. /min. /average
Automatic hot /cold detection	Auto hot or cold markers
Isotherm	Detect high/low temperature/interval
Emissivity correction	Variable from 0.01 to 1.0
Measurement corrections	Emissivity, ambient temperature, distance, relative humidity, offset temperature
<b>Storage Of Videos</b>	
Storage media	4Gbytes Micro SD card
Video storage format	Standard MPEG-4, 640x480@30fps, on memory card > 60 minutes
Video storage mode	IR/visual images; simultaneous storage of IR and visual images
<b>Storage Of Images</b>	
Image storage format	Standard JPEG, including measurement data, on memory card > 1000 pictures
Image storage mode	IR/visual images; simultaneous storage of IR and visual images

<b>Set-Up</b>	
laser	< class2
Set-up commands	Local adaptation of units, language, date and time formats, information of camera
Languages	multinational
<b>Digital Camera</b>	
Built-in digital camera	640x480 pixels
Built-in digital lens data	FOV 62.3°
<b>Data Communication Interfaces</b>	
Interfaces	USB-mini, audio, composite video, Micro SD slot
USB	Data transform between camera and PC
Video out	Composite(PAL and NTSC)
<b>Power System</b>	
Battery	lithium polymer battery, 4.5 hours operating time
Input voltage	DC 9V to 12V
Charging system	In camera (AC adapter)
Power management	Automatic shutdown and sleep mode (user selectable)
<b>Environmental Data</b>	
Operating temperature range	-20°C to +50°C (-4°F to +122°F)
Storage temperature range	-40°C to +70°C (-40°F to +158°F)
Humidity (operating and storage)	10%~90%
Encapsulation	IP65
Drop test	2m
Bump	25g(IEC60068-2-29)
Vibration	2g(IEC60068-2-6)
<b>Physical Data</b>	
Camera weight, incl. battery	920g
Camera size (L × W × H)	243x103x160

## 5-Structure Description

### 5.1-Back View

- 1-Infrared Camera Lens
- 2-Trigger
- 3-LCD Display
- 4-Buttons

 HOME Button

 Shutter Button

 Power Button

 Save Image Button

 Laser Button

5-Battery

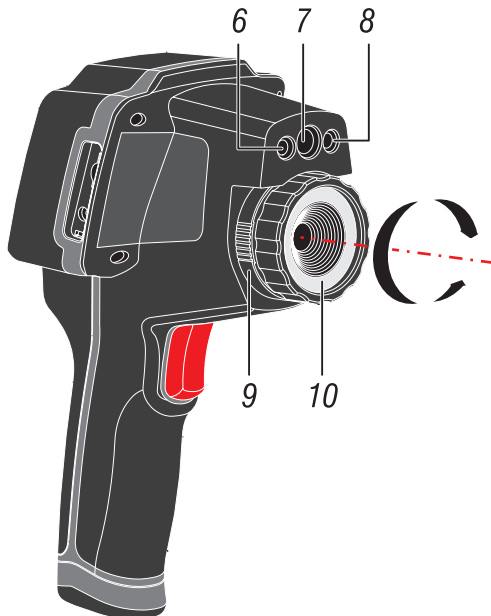
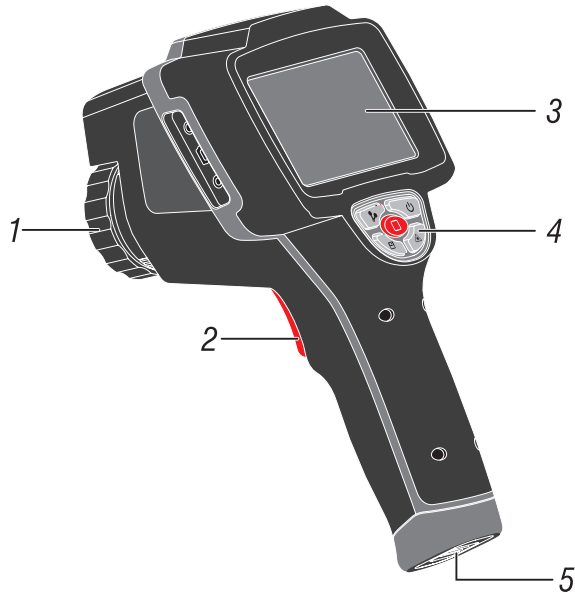

### 5.2-Front View

- 6-LED Light
- 7-Visual Camera
- 8-Laser Pointer
- 9-Infrared Camera Lens Lock
- 10-Infrared Camera Lens

### 5.3-Assembly Drawing

- 11-Liquid Crystal Display Hood
- 12-Thermal Imager
- 13-Tripod Base
- 14-Lens Cap for Infrared Lens

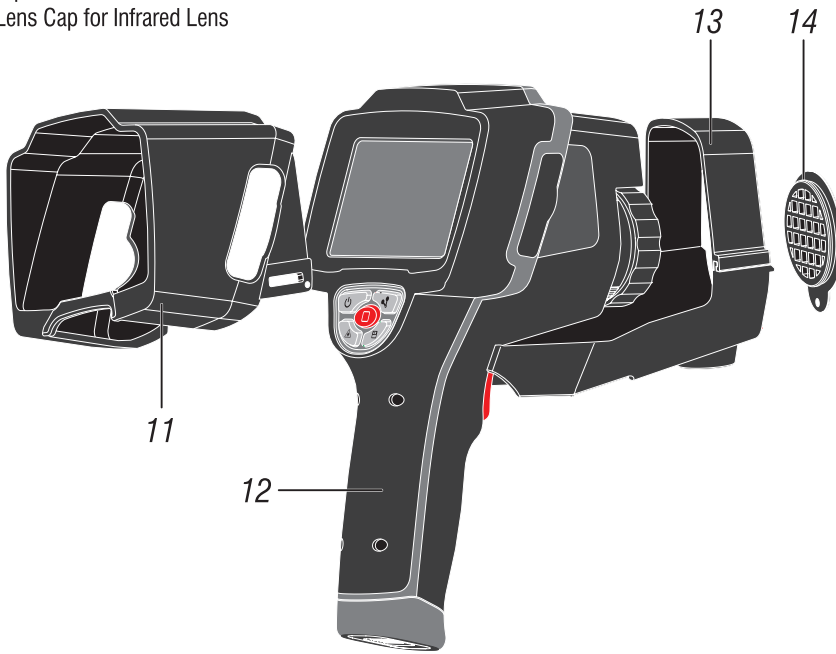

### 5.4-Interface

- 15-Video Output
- 16-USB Cable Connection
- 17-Audio/Microphone
- 18-AC Adapter/Charger Input Terminal
- 19-MicroSD Slot

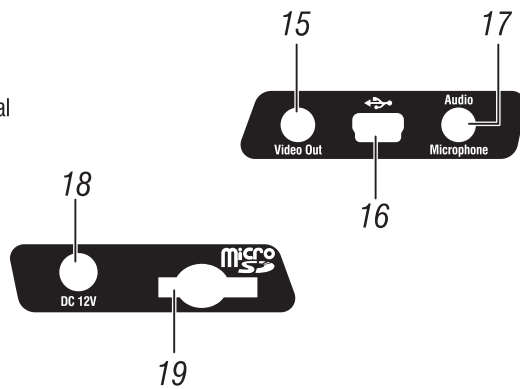

## 6-Before You Start

### 6.1-How to Charge the Battery

Before you use the Thermal Imager for the first time, charge the battery for a minimum of one and one-half hours. The battery status shows on the three-segment charge indicator.

To charge the battery, use one of the options that follow:

#### 6.1.1-Battery Charger Base

- 1-Connect the ac power supply to the ac wall outlet and connect the dc output to the charger base.
- 2-Put battery into bay of the charger base.
- 3-Charge batteries until charge indicators show "full".
- 4-Remove battery and disconnect the power supply when batteries are fully charged.

#### 6.1.2-AC Power Socket







1-Connect the AC power adapter into an AC wall outlet and connect the DC output to the Thermal Imager's AC power socket. The battery indicator becomes "  →  →  →  " in the upper right corner of the display while the battery charges with the AC power adapter.

2-Charge until the charge indicator on the display becomes "  ".

3-Disconnect AC power adapter when the battery is full charged.

#### Note

Make sure that the Thermal Imager is near room temperature before you connect it to the charger. Do not charge in hot or cold areas. When you charge in extreme temperature, battery capacity may be decreased.

"  " shows in the upper right corner of the display when the Thermal Imager is connected to AC power and the battery is removed. When the Thermal Imager's power is off and the AC power adapter is connected, the battery indicator becomes "  →  →  →  " in the center of the display to show the battery charger is in process. When the battery is full charged, "  " shows in the center of the display.

Keep the Thermal Imager attached to the charger until the battery condition icon show "  ". If you remove the Thermal Imager from the charger before a full charge shows, it may have a reduced run-time.

### 6.2-Power On and Off

To turn the Thermal Imager on or off, push and hold the Power "  " Button for three seconds. When Thermal Imagers power on, there is another way to power off, do the following:

1-Push and hold the Power "  " Button for two seconds, popup the menu.

2-Slide "  " to the right, the device will be power off.

When Thermal Imagers power on, Push the Power "  " Button to the LCD power on or off. If the Screen Off feature is on, the LCD power off after the setting time of inactivity. If the Power off feature is on, the Thermal Imager power off after the setting time of inactivity. For information about how set this feature, see **Page 32**.

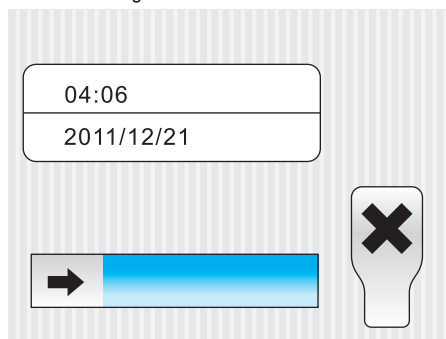

**Note**

Thermal Imager needs sufficient warm-up time for the most accurate temperature measurements and best image quality. This time can often vary by environmental conditions. It is best to wait a minimum of 10 minutes if the most accurate temperature measurement is very important to your application.

**6.3-Main Interface**

The Main Interface is as follow

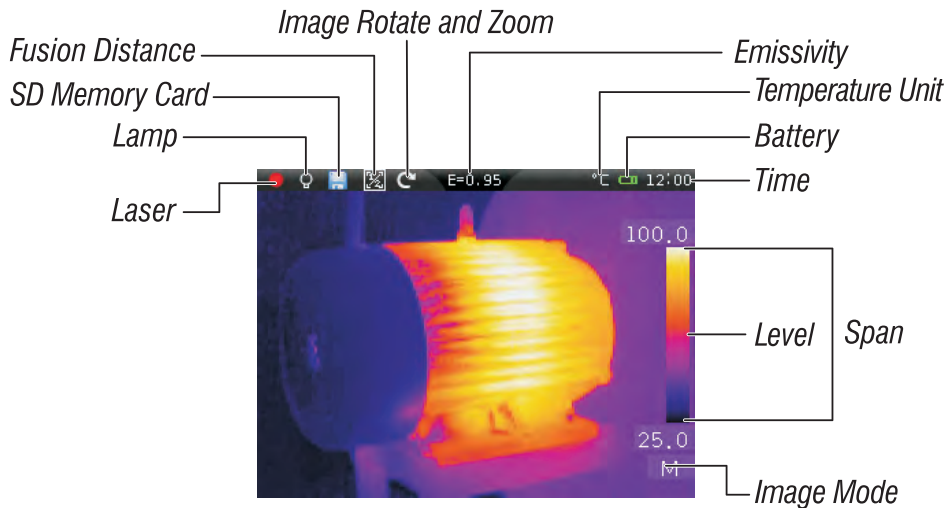

**6.4-Optical Lens**

The Thermal Imager has 3 kinds of Optical Lens. To change lens, Anti-clockwise rotates the **Infrared Camera Lens Lock** to unlock the lens, then pull out lens, put the new lens, clockwise rotates the **Infrared Camera Lens Lock** to lock lens.

Different lens has different field of view (FOV). **FOV** is the largest area that your imager can see at a set distance.

This table lists the horizontal FOV, vertical FOV and IFOV for every lens.

Focal Length	Horizontal FOV	Vertical FOV	IFOV
11mm	47.1°	36.2°	2.27mrad
22mm	24.6°	18.6°	1.14mrad
33mm	13°	9.8°	0.6mrad

**IFOV** (Instantaneous Field of View) is the smallest detail within the FOV that can be detected or seen at a set distance, the unit is rad. The formula is this:

$$\text{IFOV} = (\text{Pixel Size}) / (\text{Lens focal length});$$

D:S theoretical ( = 1/ IFOV theoretical) is the calculated spot size based on the pixel size of the Thermal Imager detector array and lens focal length.

Example: If Thermal Imager uses 22mm lens, because the Pixel Size of detector is 25um. Horizontal FOV is 24.6°, Vertical FOV is 18.6°, the IFOV is

$$25\mu\text{m}/22\text{mm} = 1.14\text{mrad};$$

$$\text{D:S theoretical (} = 1/ \text{IFOV theoretical)} = 877:1$$

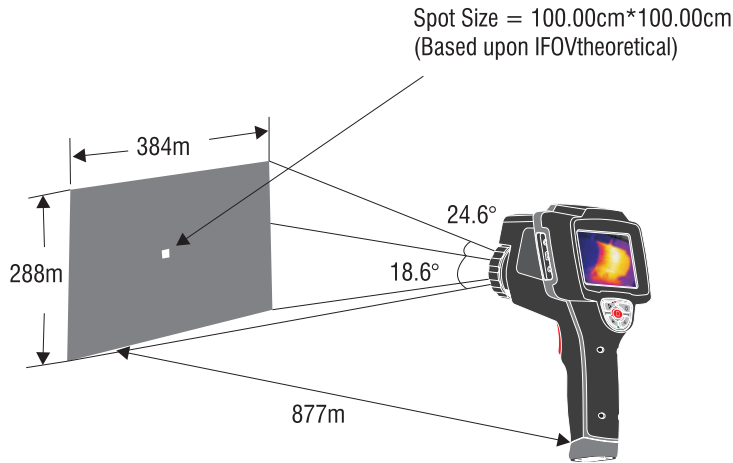

$$\text{D:S theoretical} = 877:1$$

IFOV = instantaneous Field of view

D:Smeasure ( = 1/ IFOV measure) is the spot size needed to provide an accurate temperature measure. Typically, D:Smeasure is 2 to 3 times smaller than D:S theoretical, which means the temperature measurement area of the target need to be 2 to 3 times larger than that determined by the calculated theoretical D:S.

**Note**

IFOV theoretical represents the smallest objects that the thermal imager can detect or see. IFOVmeasure represents the smallest object form which an accurate temperature can be measured by the thermal imager.

**6.5-Focus**

The Thermal Imager has IR-OptiFlex focus in manual mode. To adjust focus, clockwise or Anti-clockwise rotates the IR Lens. When target comes into focus, it shows a sharper image. When the target moves out of focus, the thermal image becomes blurry.

**Note**

Correct focus is important in all imaging applications. Correct focus makes sure that the infrared energy is correctly directed onto the pixels of the detector. Without the correct focus, the thermal image can be blurry and the radiometric data will be inaccurate. Out-of-focus infrared images are frequently unusable or of little value.

**6.6-Shutter**

The thermal image of the Thermal Imager becomes blurry, when the Thermal Imager no correcting after some minutes or the Thermal Imager changes target. To get fine thermal image, the Thermal Imager need to correct.

The Thermal Imager has two mode for correcting, Manual and Auto Mode. In Manual Mode, push the Shutter “” button, the Thermal Imager will correct. In Auto Mode, the Thermal Imager can correct automatically while The thermal image of the Thermal Imager becomes blurry.

### 6.7-Temperature Measurement

All objects radiate infrared energy. The quantity of energy radiated is base on the actual surface temperature and the surface emissivity of the object. The Thermal Imager senses the infrared energy from the surface of the object and uses this data to calculate an estimated temperature value. Many common objects and materials such as painted metal, wood, water, skin, and cloth are very good at radiating energy and it is easy to get relatively accurate measurements. For surfaces that are good at radiating energy (high emissivity), the emissivity factor is  $\geq 0.90$ . This simplification does not work on shiny surfaces or unpainted metals as they have an emissivity of  $< 0.6$ . These materials are not good at radiating energy and are classified as low emissivity. To more accurately measure materials with a low emissivity, an emissivity correction is necessary. Adjustment to the emissivity setting will usually allow the Thermal Imager to calculate a more accurate estimate of the actual temperature. More information please see **Emissivity Adjustment** to get the most accurate temperature measurements.

### 6.8-Emissivity Adjustment

The correct emissivity value is important to make the most accurate temperature measurement. Emissivity of a surface can have a large effect on the apparent temperatures that the Thermal Imager observes. Understanding the emissivity of the surface, but may not always, allow you to obtain more accurate temperature measurements.

#### Note

Surfaces with an emissivity of  $< 0.60$  make reliable and consistent determination of actual temperature problematic. The lower the emissivity, the more potential error is associated with the Imager's temperature measurement calculations. This is also true even when adjustments to the emissivity and reflected background adjustments are performed properly.

Emissivity is set directly as a value or from a list of emissivity values for some common materials. The global emissivity displays in LCD Screen as  $E=x.xx$ .

The following table gives typical emissivity of important materials.

Material	Emissivity
Asphalt	0.95
Concrete	0.95
Hard plaster	0.90
Wood (natural)	0.93
Lime Stone	0.98
Ballast chipping	0.95
Paper (every color)	0.95
Plastics non transparent	0.95
Tissue (fabric)	0.95
Sand	0.90
Glass wool	0.90
Melted asphalt	0.93
Screed/attic/pavement	0.93
Foamed polystyrene	0.94

Material	Emissivity
Drywall	0.95
Render	0.94
Smoothing cement	0.90
Lacquer	0.92
Latex paint	0.97
Wallpaper	0.93
Tiling	0.93
Parquet floor	0.90
Laminate	0.90
PVC-Floor	0.92
Brick	0.93
Cliff	0.97
Roofing cardboard	0.93
Stucco	0.91

### 6.9-Reflected Temperature

Using the offset factor, the reflection is calculated out due to the low emissivity and the accuracy of the temperature measurement with infrared instruments is improved. In most cases, the reflected temperature is identical to the ambient air temperature. Only when objects with strong emissions with much higher temperature are in the proximity of the object being measured should be determined and used. The reflected temperature has only little effect on objects with high emissivity. The reflected temperature can be set individually.

Follow these steps to get the right value for the reflected temperature.

- 1-Set the emissivity to 1.0
- 2-Adjust the optical lens to near focus
- 3-Looking in the opposite direction away from the object, take a measurement and freeze the image
- 4-Determine the average value of the image and use that value for your input of reflected temperature.

### 6.10-Thermal Imager Reporter Software

Thermal Imager Reporter software is supplied with the Thermal Imager. This Software is intended for Thermal Imager and contains feature to analyze images, organize data and information, and make professional reports. Thermal Imager Reporter software allows audio annotations and commentary to be reviewed on a PC.

## 7-Menus

The menus, together with buttons, are access for image, measurement, camera, photo, play, and settings.

### 7.1-Main Menu

Main Menu is the main interface of the Thermal Imager's menus. It contains six items such as Measure, Image, Camera, Photo, Play, Settings.



**Measure:** set for the calculation and display of radiometric temperature measurement data related to the thermal images.



**Image:** set for the display on the Thermal Imager's LCD.

**Camera:** contains the snapshot and video function. Snapshot function saves .jpg image, and add audio annotation and text annotation in .jpg image. Video function allows the user to capture .mp4 video and add audio annotation in .mp4 video. Images and videos file can be used for analysis by PC software.

**Photo:** reviews thumbnail of images which saved is SD Memory Card. Allows the user to delete, Zoom in/out, rotate images, play audio annotation and show text annotation.

**Play:** reviews thumbnail of the video files which saved is SD Memory Card. And, allows the user to delete, play the video files and audio annotation.

**Settings:** set for the user preferences such as language, unit of temperature measurement, unit of distance, date, time and some other settings.

Push HOME “” button or press blanks of the main interface, popup the Main Menu. When main menu has displayed, Push HOME “” button or press blanks of the Main Menu, hide the Main Menu.

## 7.2-Image Menu

In main menu, press image icon “”, popup Image Menu which contains Image Mode, Image Palette, Image Adjust and Image Setting.



### 7.2.1-Image Mode

Thermal Imager has 6 kinds of image modes for display. IR/Visible/IR\_PIPE\_VIS/VIS\_PIPE\_IR/IR\_Mix\_VIS/VIS\_Mix\_IR.

**IR:** displays only infrared image;

**Visible:** displays only visible image;

**IR\_PIPE\_VIS and VIS\_PIPE\_IR:** display infrared and visible image at the same time;

**IR\_Mix\_VIS and VIS\_Mix\_IR:** display fusion image of infrared and visible images.

In Image Menu, press the icon “”, shows the page of Image Mode. Press left arrow or right arrow to change image mode.

In IR\_PIPE\_VIS and VIS\_PIPE\_IR mode, There are four options for image pipe position: Topleft, BottomLeft, BottomRight, TopRight. In “Position: XX” item, Press left arrow or right arrow to change image pipe position. Note: TL: TopLeft; BL: BottomLef; BR: BottomRight; TR: TopRight.



In IR\_Mix\_VIS and VIS\_Mix\_IR mode, In “Size: XX” item, press left arrow or right arrow to change image mix size. There are two options: Half or Full. In “Blend: XX%” item, press left arrow or right arrow to change image mix percentage. The range is 0%~100%.



### 7.2.2-Image Palette

The Image Palette lets you change the false-color presentation of the infrared images on display or captured. A variety of palettes are available for specific applications. Thermal Imager has standard and custom palettes. The standard palettes offer an equal, linear presentation of colors that allow for best presentation of detail. The custom palettes allow user to customize personal palettes.

In Image Menu, press the icon “”, shows the page of Image Palette. There are two groups of palette, Standard Palette and Custom Palette. The \* icon represents the current image palette in the corresponding group.



#### Standard Palette

Press Standard bar, Pop up the standard palette submenu. It shows eight kinds of palettes, they are IRON/Rainbow/Grey/GreyInverted/Sepia/Blue\_Red/Hot\_Cold/Humidity. Press “OK” button to select palette, press “Cancel” button to cancel.

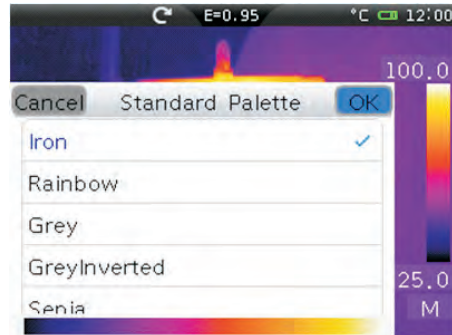

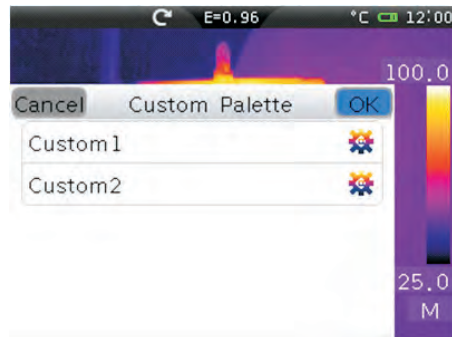

#### Custom Palette

Press Custom bar, Pop up the custom palette submenu. It shows custom palettes. User can customize personalized palette. There are at least two palettes, at most ten palettes.

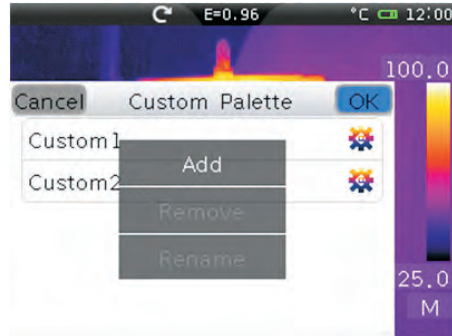

In custom palette submenu, there are “Add”, “Remove”, “Rename” functions. Long press for 1 second to show this menu. “Add” is used to add a new palette; “Remove” is used to remove a palette; “Rename” is used to rename palette. Note: when there are only two palettes, “Remove” is disabled. When there are ten palettes, “Add” is disabled. When palette is selected, “Rename” is enabled.



Press the icon “”, popup the menu for setting palette. There is a color bar to display current palette. The every color value is based on liner gradient. “0.0” item displays the minimum value, “50.0” displays the maximum value. There are 3 scales, which the value is based on position, the minimum value and maximum value. Press and move every scale can change the position.

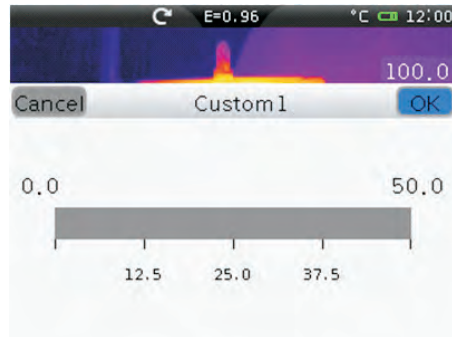

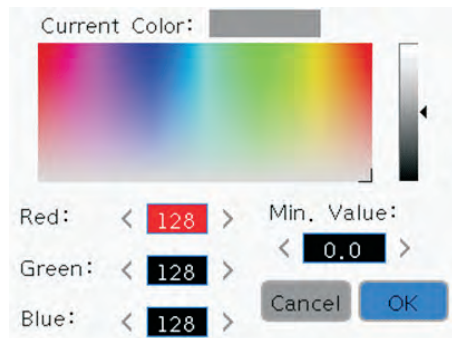

Press “0.0” or “50.0” to show menu for minimum or maximum parameter settings. “Min. Value” shows the minimum value. “Max. Value” shows the maximum value. Click color bar to choose a color, “Current Color” shows current selected color. “Red”, “Green” and “Blue” shows the color value of selected color. Press the left arrow or right arrow can change the corresponding value. Press “OK” button to save parameter settings, Press “Cancel” button to cancel parameter settings.

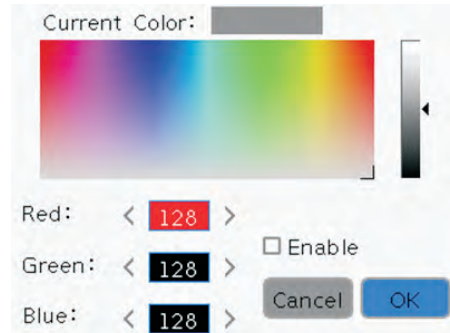

Press every scale to popup menu for parameter settings. click “Enable” to switch on (checked) or off (unchecked). Click color bar to choose a color, “Current Color” shows current selected color. “Red”, “Green” and “Blue” shows the color value of selected color. Press the left arrow or right arrow can change the corresponding value. Press “OK” button to save parameter settings, Press “Cancel” button to cancel parameter settings.



If “Enable” is switched on (checked), it means to enable linear gradient in this scale, the icon “” shows in the top of scale. If “Enable” is switched off (unchecked), it means to disable linear gradient in this scale, the icon “” will hide;

### 7.2.3-Image Adjustment

There are 3 kinds of modes for thermal image adjustment, they are All Auto/Histogram/Manual. Press left arrow or right arrow to change image adjustment.

**All Auto:** level and span are decided by the thermal image of minimum temperature and maximum temperature.

**Histogram:** level and span are decided by the Histogram of thermal image temperature.



**Manual:** level and span are decided by the manual values, which decide by “Max Temp” and “Min Temp”, Press the left arrow or right arrow to change the value.

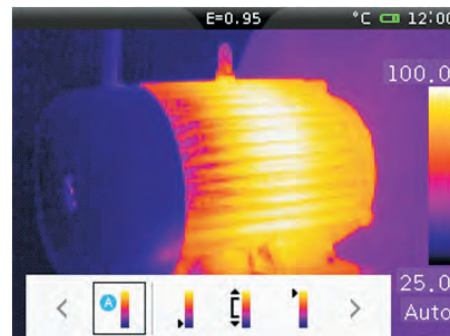

In image menu, press the icon “”, shows the page of Image Adjustment.

In Manual mode, press “Adjust” to open the menu for the adjustment of level and span. In the Main Interface, press the value of “Colorbar min temperature” and “Colorbar max temperature”, or “Image Mode” to open the menu for the image adjustment.



Press the icon “”, then press left arrow or right arrow to change image mode. There are two types of icons to change. “” means **Auto Mode**, “” means **Manual Mode**.

Press “”, “” or “” to adjust “Colorbar min temperature”, span and “Colorbar max temperature”.

### 7.2.4-Image Setting

In Image Menu, press the icon “☀️”, show the page of Image Setting. It contains the “ISO” and “Clear Screen”. “ISO” is used for isothermal analysis. It allows to Thermal Imagers displays a setting color for infrared image, which temperature is in the given range.



Press “ISO” bar to switch on/off isothermal analysis. The Icon “✓” means to open isothermal analysis; the Icon “✗” means to close isothermal analysis. Press the icon “☀️”, popup the submenu of “ISO” settings. This submenu contains settings for isothermal mode, isothermal temperature, isothermal range, and isothermal color. Isothermal mode has Inter, Above, Below. The Inter mode means infrared image which the temperature in the range of [“IsoMax”, “IsoMin”] is set to Color; The Above mode means the infrared image which the temperature is greater than “IsoMax” is set to Color; The Below mode means the infrared image which the temperature is less than “IsoMin” is set to Color. The Color has Black, White, Green and Red to select.



Press “Clear Screen” bar to show only image in the screen. The Icon “✓” means to clear screen, The Icon “✗” means to don’t clear screen.

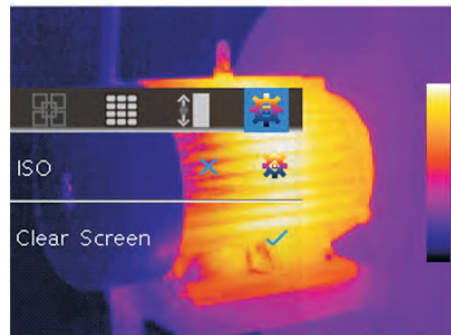

### 7.2.5-Zoom and Rotation

Thermal Imager offers 1-20x continuous zoom and 0°– 360°rotation functions. Press the icon “🔄” which in top-left of the display, popup the menu of Zoom and Rotation. In the menu of Zoom and Rotation, press the icon “🏠”, Image restores to its original state, without zoom and rotation. Press the icon “OK” or Push HOME “🏠” button, exit current menu.

#### Zoom

Press the icon “-”, image zoom out 10%, long press will continue to zoom out. Press the icon “+”, image zoom in 10%, long press will continue to zoom in. When zoom in or zoom out, the zoom factor displays in the upper-right corner of the display.

#### Rotation

Press the icon “↶”, image counterclockwise rotates 1°, long press will continue to rotate and accelerate the speed of rotation.

Press the icon “↷”, image counterclockwise rotates 1°, long press will continue to rotate and accelerate the speed of rotation.

When rotated an angle, the angle of rotation displays in the upper-right corner of the display.

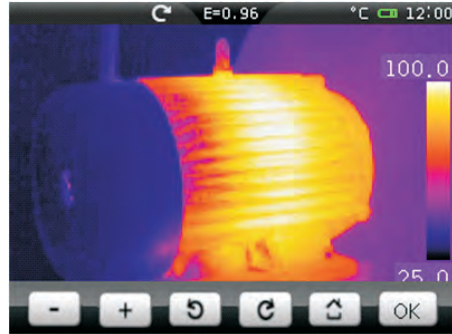

### 7.3-Measurement Menu

In main menu, press measurement icon “📏”, popup Measurement Menu which contains Point Measurement/Line Measurement/Area Measurement and Measurement Settings.

**Point Measurement:** Measure the selected points, each point can move, capture maximum temperature and minimum temperature.

**Line Measurement:** Use temperature curve to display the profile for measured target.

**Area Measurement:** Measure the selected area, contains maximum temperature, minimum temperature and average temperature.









#### 7.3.1-Point Measurement

In measurement menu, press the icon “+”, shows the page of Point Measurement. There are 3 points to measure. Each point has third kinds of mode: manual mode, maximum temperature capture, minimum temperature capture. Each point can use global parameter settings or private parameters to set the measuring parameters.

#### Open and Close



Press Spot 1, Spot 2, Spot 3 to open the corresponding point of the temperature measurement. The Icon “✓” means to open point measurement, The Icon “X” means to close point measurement.

### Set Point Mode

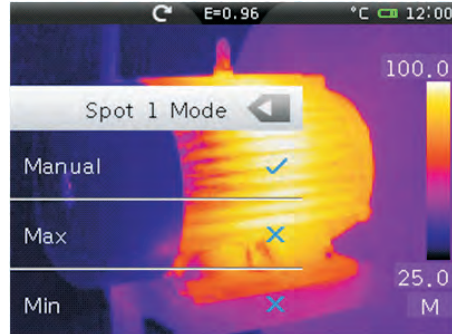
Press the icon “”, popup the submenu of the point mode. Press “Manual” to select manual mode, current point’s icon “” becomes “”; Press “Max” to select maximum temperature capture mode, current point’s icon becomes red icon “”; Press “Min” to select minimum temperature capture mode, current point’s icon “” become green icon; The Icon “” means to not select, The Icon “” means to select.



### Set Point Parameters

Press the icon “”, popup the submenu of the point parameters. Press “use global para” to use global parameters for measuring. The Icon “” means to select, The Icon “” means to not select.

When the point selects to use global parameters for measuring, “Emiss”, “Distan”, “Offset” becomes disabled. When the point selects to use private parameters for measuring, “Emiss”, “Distan”, “Offset” becomes enabled. “Emiss” sets object emissivity, the value range is 0.01~1.00; “Distan” sets object distance, the value range is 0~5000; “Offset” sets object offset, the value range is -100°C~100°C;

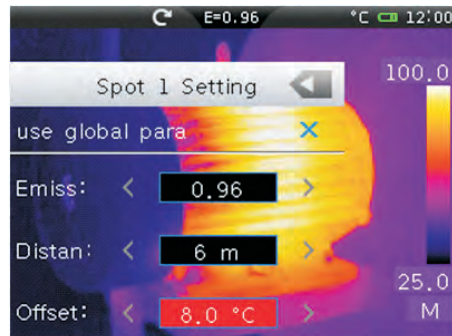



### 7.3.2-Line Measurement

In measure menu, press the icon “”, show the page of Line Measurement. There are 2 lines to measure. Each line can use global parameter settings or private parameters to set the measuring parameters.



### Open and Close



Press “Hor Line” to open horizontal line, and, press “Ver Line” to open vertical line. The Icon “” means to open, The Icon “” means to close.

### Set Line Mode

Press the icon “”, popup submenu of the line’s mode. “Row” sets the row of line, the value range is 1~240; “Column” sets the column of line, the value range is 1~320.



### Set Line Parameters

Press the icon “”, popup the submenu of the line’s parameters. Press “use global para” to use global parameters for measuring. The icon “” means to select, The icon “” means to not select.

When the line selects to use global parameters for measuring, “Emiss”, “Distan”, “Offset” becomes disabled. When the line selects to use private parameters for measuring, “Emiss”, “Distan”, “Offset” becomes enabled. “Emiss” sets object emissivity, the value range is 0.01~1.00; “Distan” sets object distance, the value range is 0~5000; “Offset” sets object offset, the value range is -100°C ~100°C;

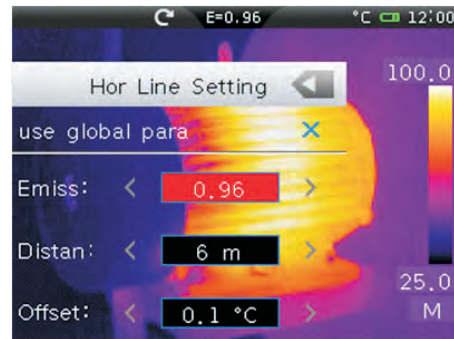

### 7.3.3-Area Measurement





In measure menu, press the icon “”, show the page of Area Measurement. There are 3 areas to measure. Each area has the measurement of maximum temperature, minimum temperature and average temperature. Each area can also use global parameter settings or private parameters to set the measuring parameters.



### Open and Close



Press Area 1, Area 2, Area 3 to open the temperature measurement of the corresponding area. The icon “” means to open point measurement, The icon “” means to close point measurement.

### Set Area Mode

Press the icon “”, popup the submenu of the area mode. Press “Max” to select maximum temperature capture mode, the red icon “” displays maximum temperature of the area; Press “Min” to select minimum temperature capture mode, the green icon “” displays minimum temperature of the area; Press “Averg” to display average temperature of the area. The Icon “” means to open, The Icon “” means to close.



### Set Area Parameters

Press the icon “”, popup the submenu of the area parameters. Press “use global para” to use global parameters for measuring. The Icon “” means to select, The Icon “” means to not select.

When the area selects to use global parameters for measuring, “Emiss”, “Distan”, “Offset” becomes disabled. When the point selects to use private parameters for measuring, “Emiss”, “Distan”, “Offset” becomes enabled. “Emiss” sets object emissivity, the value range is 0.01~1.00; “Distan” sets object distance, the value range is 0~5000; “Offset” sets object offset, the value range is -100°C~100°C;

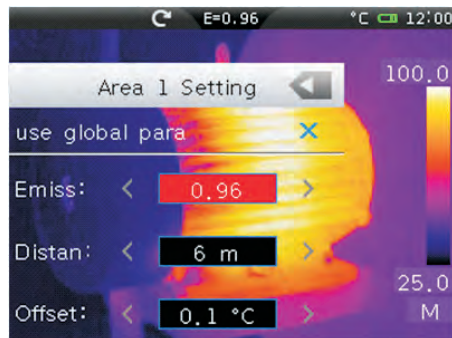

### 7.3.4-Measurement Settings

In measure menu, press the icon “”, popup the menu of Parameter Settings. The menu contains global parameters setting, measure parameters setting and alarm settings.



### Global Parameters Settings

Press “Global Para” to popup the submenu of global parameters settings.



Press “Reset Para” to popup reset parameter dialog. Press “Yes” to reset global parameters to default parameters; press “No” to cancel.

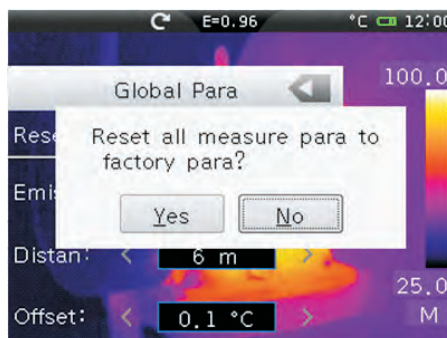

### Factory parameters

Global Measure Parameters	Emissivity	0.95
	Distance	5m
	Ambient Temperature	25°C
	Humidity	60%
	Reflection Temperature	25°C
	Offset	0.0°C

### Measurement Setting

The menu of Measurement Settings displays current infrared optical lens, and also has adjustments for temperature measurement range, ambient temperature, humidity, and reflection temperature. Thermal Imager has 3 kinds of lens: “11mm”, “22mm”, and “44mm”. “22mm” is the standard accessory, others are optional for user.

The temperature measurement ranges have “-20~150°C” and “0~400°C” to choose. The overlap temperature of the two ranges is more accurate to choose “-20~150°C”.

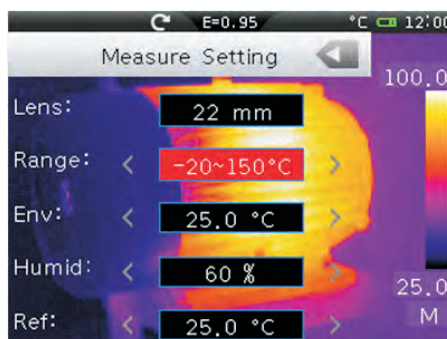

The ambient temperature, humidity and reflection temperature are important for radiometric temperature measurement. Thermal Imager has temperature compensation for these values. To get more accurate temperature measurement, accurately set the ambient temperature, humidity and reflection temperature. In most cases, the reflected temperature is identical to the ambient temperature. Only when objects with strong emissions with much higher temperature are in the proximity of the object being measured, the reflected temperature is different of the ambient temperature and must set the temperature of environment.

Press “Measure setting” to popup the submenu of Measure Setting. “Lens” display current optical infrared lens, “Range” sets the range of temperature measurement; “Env” sets ambient temperature; “Humid” sets humidity; “Ref” sets reflected temperature.

### Alarm

Thermal Image has alarm function to beep. There are 3 kinds of alarm mode: “Above”, “Below” and “Equal”. The “Above” mode will start to alarm when temperature is above to setting temperature; The “Below” mode will start to alarm when temperature is below to setting temperature; The “Equal” mode will start to alarm when temperature is equal to setting temperature.

### Alarm open and close

Press “Alarm” to open temperature alarm, The Icon “ ✓ ” means to open, The Icon “ ✕ ” means to close.

### Alarm Settings

Press the icon “ ⚙️ ” to popup submenu of Alarm Settings.

“**Target**” : sets the target of temperature alarm, there are 3 kinds of choices; Spot 1, Spot 2, Spot3;

“**Mode**” : sets the alarm mode, “Above”, “Below”, “Equal”.

“**Temp**”: sets alarm temperature value.

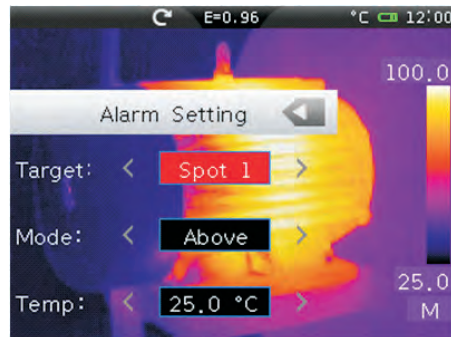

### 7.4-Camera Menu

Thermal Imager has photo and video functions. In photo function, the Imager can save thousands of images. Every image resolution is 640\*480, format is .jpg, and stores infrared data and visible data in an image. In video function, the Imager has .mp4 video capture for hours, and save infrared data in .mp4 format.

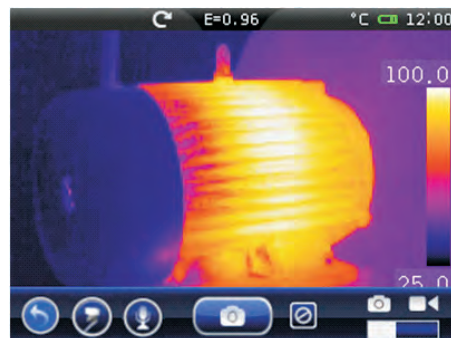

**Note**









Images and video files are stored in SD Memory Card. Images can easily be read and second analyzed within Thermal Imager PC software.

In main menu, press camera icon “”, popup Camera Menu which contains Snapshot Menu and Video Menu. Slide the white rectangle in the icon “” from left to right to switch form Snapshot Menu to Video Menu. Slide the white rectangle in the icon “” from right to left to switch form Video Menu to Snapshot Menu. Press the Icon “” to exit Camera Menu.

**7.4.1-Snapshot Menu**

Snapshot Menu contains Freeze Image, Save Image, Sound Recording, and Text Annotation.

**Freeze Image**



Press the icon “”, the image will be frozen. Then, the icon becomes icon “”. If current image is frozen, the icon “” becomes “”. Press the icon “” to make the image to free, and the icon “” becomes back , the icon “” becomes back . When the image is frozen, the upper-right corner of the screen will show the icon “”.

**Save Image**



When the image is frozen, Press the icon “”, Thermal Imager will save an image, if Thermal Imager have inserted SD Memory Card. After saving image, the icon “” becomes back to the icon “” .

**Note:** there is a quick way to save the image. Press key Button “” to save an image.

**Sound Recording**



1-In snapshot menu, after saved an image, the icon “” becomes enabled, and then presses the icon “” to popup submenu for Sound Recording.

2-Press the icon “” to start to record sound. Then, the icon becomes “”. Press again will finish sound recording.

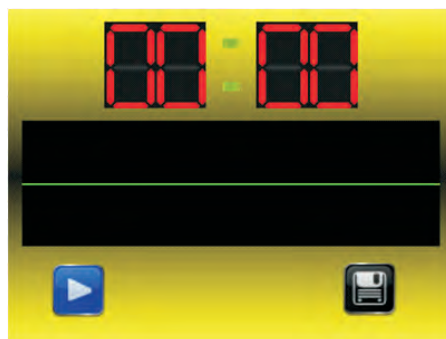
3-Press the icon “” to save data. Push HOME “” button to donor save data and exit current menu.



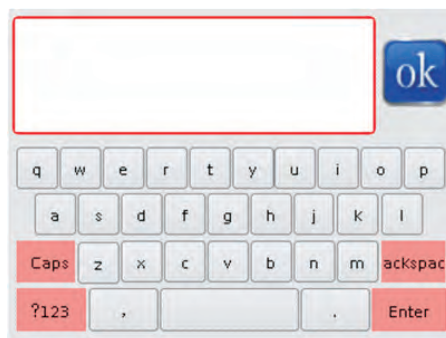

**Text Annotation**

In snapshot menu, when the icon the icon “” shows, press the icon “” to popup submenu for Text Annotation. Press the icon “” to save text annotation.



### 7.5-Video Menu

The Thermal Imager has .mp4 video capture. In Camera Menu, slide the white rectangle in the icon “” to the right, Video Menu shows as follow:

Press the icon “” to start video capture, and the icon becomes “”. Press again to stop video capture. Press the icons “” to exit Video Menu.





### 7.6-Photos Browser

In main menu, press the icon “”, popup Photos Browser, Which displays images that save in SD Memory Card.

#### 7.6.1-Multi-Photos Browser

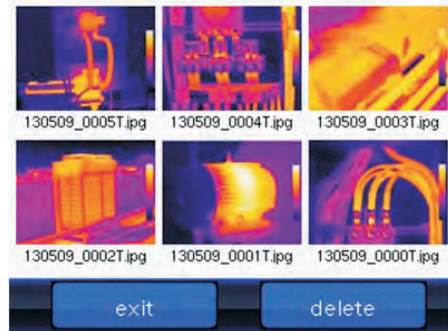
Slide touch screen from right to left, displays previous page. Slide touch screen from left to right, displays next page. Press the HOME “” button to exit Photos Browser.



Press “delete to show delete menu. Press an image to select, the image shows the icon “”, then press “delete” to delete selected image. Press “Select All” to select all images, all images show the icon “”, then press “delete” to delete all images. If selected all vido images, press “UnSelect All” to deselect. Press “back” to return back to Multi-Photos Browser Menu.

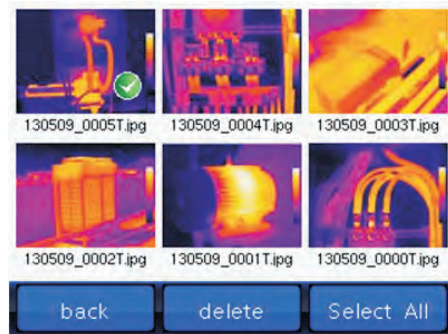

### 7.6.2-Single-Photos Browser

Press any photo, shows photo as follow:

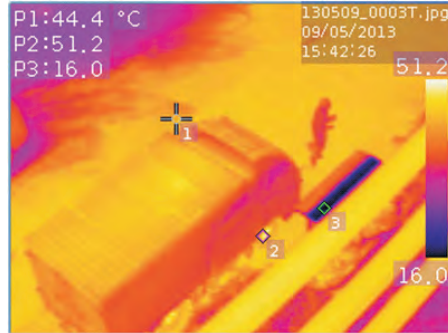

Press the photo to operate, the interface like this:

1-Press the icon “<” to show previous image, press the icon “>” to show next image.

2-Press the icon “+” to zoom in the image, press but not release, the image will continue to zoom in.

3-Slide the touch screen to move the image.

4-Press the icon “↻” to rotate the image, press but not release, the image will continue to rotate

5-Press the icon “-” to zoom out the image, press but not release, the image will continue to zoom out.

6-Press the icon “✕” to delete the image.

7-Press the icon “⏪” to exit photos Browser.

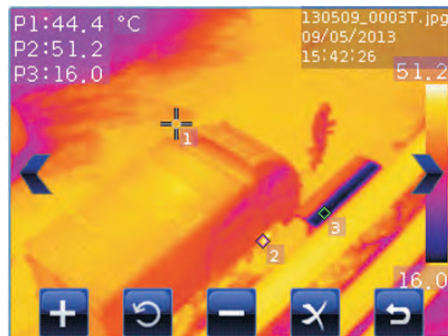

### 7.7-Player Menu

The Player Menu previews, deletes, and plays video files. In Main Menu, press the icon “▶”, popup Player Menu, which previews video files that save in SD Memory Card. Vertically slide screen to review more video files. Press “exit” to exit the Player Menu.

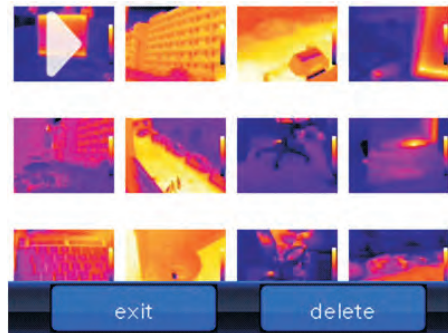

Press “delete” to show delete menu. Press a video file to select, the file shows the icon “✔”, then press “delete” to delete selected video file. Press “Select All” to select all video files, all file show the icon “✔”, then press “delete” to delete all files. If selected all vido files, press “UnSelect All” to deselect. Press “back” to return back to Player Menu.



In Player Menu, Press the video file to play, the menu shows as:

- 1-The icon “⏏” is used to stop playing.
- 2-The icon “▶” is used to play;
- 3-The icon “☰” is used to popup Player Menu for previewing video files;
- 4-The icon “🔊” is used to adjust volume, slide up the slider to increase volume, slide down the slider to decrease volume.
- 5-The icon “☰” is used to exit the Player Menu.

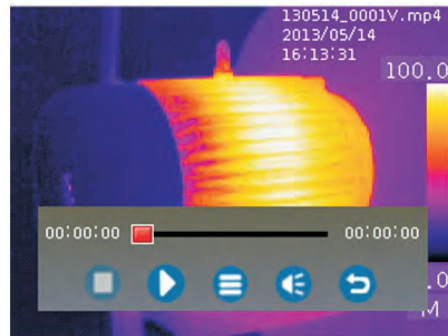

## 7.8-Settings Menu

In main menu, press the icon “⚙️”, popup the Settings Menu. The settings menu has General Page, Control Page, Photos Page, Date & Time Page and Info page.

### 7.8.1-General Page

The General Page has settings for language, analog output, temperature precision, temperature unit, distance unit.



### Language Select

Press “Language” to popup the submenu for selecting language. Press “Done” to set selected language, press “Cancel” to cancel selected language.

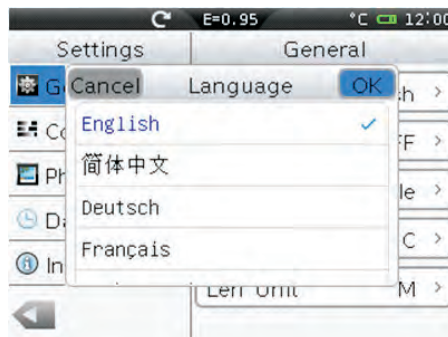

### Analog Output

The video output available in the Thermal Imager (see the page 10, “Video Output” of the **Interface**) enables displaying the thermal image(includes operator menu) on an external monitor or video recording device capable of managing PAL or NTSC systems. To connect the Thermal Imager, proceed as follows:

- 1-Connect the Thermal Imager to the external monitor or recording device using the video cable provided.
- 2-Turn on the external monitor or device.
- 3-Power on the Thermal Imager.
- 4-In the **general** page of **setting menu**, press **Output** item for setting the mode of analog output, has “Off”, “PAL”, “NTSC” to select. Press “Output” to change mode. “Off” means power off the analog output.
- 5-with the image displayed on th external monitor or device, the thermal imager's display works simultaneously.
- 6-Once the operations on the external device are finished, press **Output** item for setting "off" mode, the external device will become black.
- 7-Switch off the extern device and disconnect the video cable from the thermal imager.

### Temperature Precision

Set temperature precision, has “Single”, “Double” to select. When selecting “Single”, the temperatures of display will have 1 decimal; When selecting “Double”, the temperatures of display will have 2 decimal;

### Temperature Unit

Set temperature unit, has °C, °F, K to select. Conversion relationship: °F=1.8\*°C+32, K=273.15+°C.

### Distance Unit

Set distance unit, has M, FT to select. Conversion relationship: FT=0.3048\*M

### 7.8.2-Control Page

The Control Page has adjustments for Lamp, LCD Brightness, Screen Off, Power Off.



#### Lamp

The Thermal Imager has lamp to lighting, "ON" is to open lamp, "OFF" is to close it.

#### Brightness

The Thermal Imager can control brightness of LCD. If the brightness of LCD is less, the Lower power will consume. It means to have more standby time.

Press "brightness" to popup submenu of setting LCD brightness.

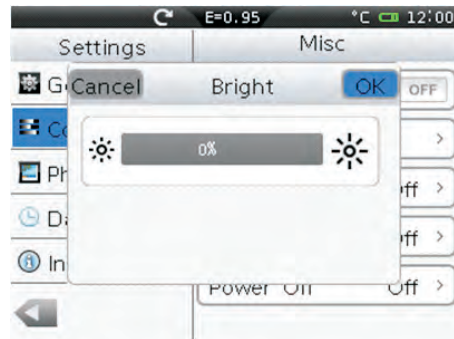

#### Screen Off

The Thermal Imager will close LCD power after LCD screen time of inactivity. There are 1 minutes, 2 minutes, 5 minutes to select for setting the time for power of LCD. "OFF" means to never close LCD power.

#### Note

When LCD power is power down, push any button or press the touch screen to open LCD power.

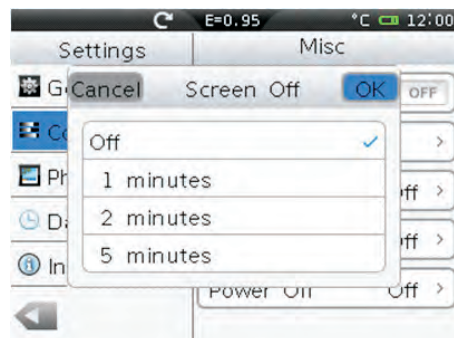

### Power Off

The Thermal Imager will shut down after shut down time of inactivity. There are 5 minutes, 10 minutes, 30 minutes to select for setting shut down time. "OFF" means to never shut down.

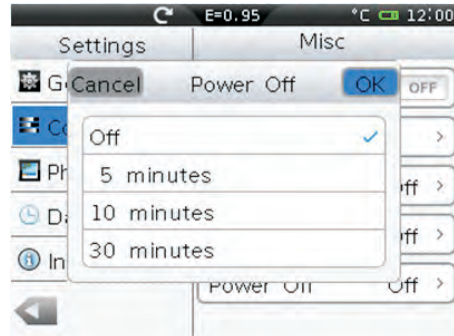

### 7.8.3-Photos Page

The Thermal Imager can auto save photos. When the period is set a value, the Thermal Imager will auto save photos in interval given value.

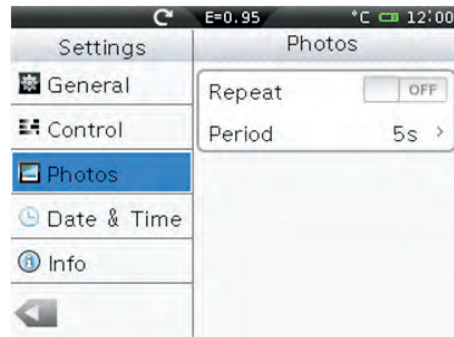

### 7.8.4-Date & Time Page

Data & Time Page has adjustments for Date, Time, AM/PM, Date Format.

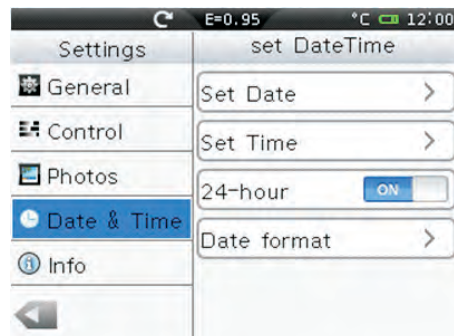

### 7.8.5-Info Page

The info page shows some information of Thermal Imager. This includes: Model, Number, Production Date, Version and SD Memory Card. The information format of SD memory card is Used/Total, unit is M.



### 7.9-Factory Settings

Factory Settings of the Thermal Imager is as follow:

Item	Parameter	Value
Measurement	Spot Measurement	off
	Line Measurement	off
	Area Measurement	off
	Isothermal Analysis	off
Measurement Parameters	Emissivity	0.95
	Distance	5m
	Ambient Temperature	25°C
	Reflected Temperature	25°C
	Humidity	60%
	Offset	0.0°C
Image	Mode	Infrared
	palette	Iron
System Setting	Adjustment	Auto
	Language	English
	Analogy Output	off
	Lamp	off
	LCD Brightness	100%
	Auto Shutter	off
	Auto Photos	off
	Screen Off	off
	Power Off	off

### 8-Fault diagnosis and exclusion

If you encounter any problems while using the thermal imager, overhaul according to the following table. If the problem persists, disconnect the power and contact with the company's technical support department.

Phenomenon of the fault	Cause of the fault	Solution
Thermal imager cannot start	No battery	Inserting the battery
	No power	Replace the battery or charge it
Thermal imager shut down	No power	Replace the battery or charge it
No Thermal image	The lens cap cover	Opened the lens cap





CE    **RoHS**

Rev. 131212