



M 50

Stoktan Teslim.
Delivery From Stock.

M 70

M 75



M 80

M 100

Stoktan Teslim.
Delivery From Stock.

M 125

M 150

KABLO MERDİVENİ YAN KENAR H:50 mm L:3000 mm
Cable Ladder Side Rail H:50 mm L:3000 mm

SİPARİŞ KODU ORDER CODE	H mm	T mm (P.G.)	AĞIRLIK (kg/m) WEIGHT (kg/m) (P.G.)	T mm (H.D.G)	AĞIRLIK (kg/m) WEIGHT (kg/m) (H.D.G.)	
M 50-10	50	1.0	0.615	—	—	
M 50-12	50	1.2	0.735	—	—	
M 50-15	50	1.5	0.920	1.5	1.015	
M 50-20	50	2.0	1.230	2.0	1.355	

KABLO MERDİVENİ YAN KENAR H:70 mm L:3000 mm
Cable Ladder Side Rail H:70 mm L:3000 mm

SİPARİŞ KODU ORDER CODE	H mm	T mm (P.G.)	AĞIRLIK (kg/m) WEIGHT (kg/m) (P.G.)	T mm (H.D.G)	AĞIRLIK (kg/m) WEIGHT (kg/m) (H.D.G.)	
M 70-12	70	1.2	0.920	—	—	
M 70-15	70	1.5	1.150	1.5	1.265	
M 70-20	70	2.0	1.535	2.0	1.690	

KABLO MERDİVENİ YAN KENAR H:75 mm L:3000 mm
Cable Ladder Side Rail H:75 mm L:3000 mm

SİPARİŞ KODU ORDER CODE	H mm	T mm (P.G.)	AĞIRLIK (kg/m) WEIGHT (kg/m) (P.G.)	T mm (H.D.G)	AĞIRLIK (kg/m) WEIGHT (kg/m) (H.D.G.)	
M 75-12	75	1.2	0.935	—	—	
M 75-15	75	1.5	1.170	1.5	1.290	
M 75-20	75	2.0	1.560	2.0	1.720	

KABLO MERDİVENİ YAN KENAR H:80 mm L:3000 mm
Cable Ladder Side Rail H:80 mm L:3000 mm

SİPARİŞ KODU ORDER CODE	H mm	T mm (P.G.)	AĞIRLIK (kg/m) WEIGHT (kg/m) (P.G.)	T mm (H.D.G)	AĞIRLIK (kg/m) WEIGHT (kg/m) (H.D.G.)	
M 80-12	80	1.2	0.950	—	—	
M 80-15	80	1.5	1.190	1.5	1.310	
M 80-20	80	2.0	1.590	2.0	1.750	

KABLO MERDİVENİ YAN KENAR H:100 mm L:3000 mm
Cable Ladder Side Rail H:100 mm L:3000 mm

SİPARİŞ KODU ORDER CODE	H mm	T mm (P.G.)	AĞIRLIK (kg/m) WEIGHT (kg/m) (P.G.)	T mm (H.D.G)	AĞIRLIK (kg/m) WEIGHT (kg/m) (H.D.G.)	
M 100-15	100	1.5	1.380	1.5	1.520	
M 100-20	100	2.0	1.840	2.0	2.025	

KABLO MERDİVENİ YAN KENAR H:125 mm L:3000 mm
Cable Ladder Side Rail H:125 mm L:3000 mm

SİPARİŞ KODU ORDER CODE	H mm	T mm (P.G.)	AĞIRLIK (kg/m) WEIGHT (kg/m) (P.G.)	T mm (H.D.G)	AĞIRLIK (kg/m) WEIGHT (kg/m) (H.D.G.)	
M 125-15	125	1.5	1.630	1.5	1.795	
M 125-20	125	2.0	2.175	2.0	2.390	

KABLO MERDİVENİ YAN KENAR H:150 mm L:3000 mm
Cable Ladder Side Rail H:150 mm L:3000 mm

SİPARİŞ KODU ORDER CODE	H mm	T mm (P.G.)	AĞIRLIK (kg/m) WEIGHT (kg/m) (P.G.)	T mm (H.D.G)	AĞIRLIK (kg/m) WEIGHT (kg/m) (H.D.G.)	
M 150-15	150	1.5	1.420	1.5	1.560	
M 150-20	150	2.0	1.890	2.0	2.080	

*H50 ve H100 yan kenarlar P.G. ve H.D.G. olarak stoklarda mevcuttur.

*Sipariş miktarına göre farklı kalınlıklarda üretim yapılabilmektedir.

*H50 mm and H100 mm side rails are always in stock as pre-galvanized or hot dip galvanized as shown on thickness chart.

*Different type of material thicknesses can be produced on request.

Lütfen siparişlerinizde ürün kodu ve kaplama şeklini belirtiniz.

Please indicate order code and the shape of coating in your orders.

* Standart bir boy merdiven için toplam 2 adet yan kenar kullanılmaktadır.

* Merdiven montajı için montaj kılavuzunu okuyunuz.

* 2 pieces of sides are required for a standard sized ladder.

* For installation , please read the montage instructions

Minimum kalınlık toleransı : ± 0,10
Minimum thickness tolerance : ± 0,10

KABLO MERDİVENİ ARA BASAMAKLARI

Cable Ladder Rungs

SİPARİŞ KODU ORDER CODE	L mm	T mm (P.G)	AĞIRLIK (kg/ad) WEIGHT (kg/pc)	T mm (H.D.G.)	AĞIRLIK (kg/ad) WEIGHT (kg/pc)	
MA 100	100	1.2	0.075	1.5	0.105	
MA 200	200	1.2	0.140	1.5	0.195	
MA 300	300	1.2	0.195	1.5	0.270	
MA 400	400	1.2	0.260	1.5	0.360	
MA 500	500	1.2	0.320	1.5	0.450	
MA 600	600	1.5	0.490	1.5	0.540	

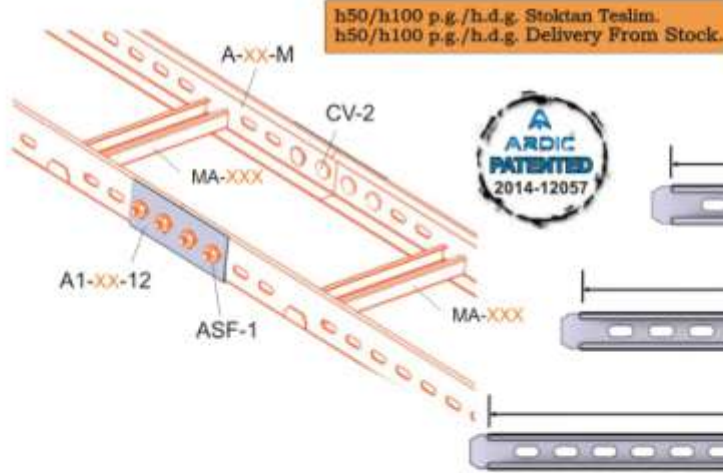
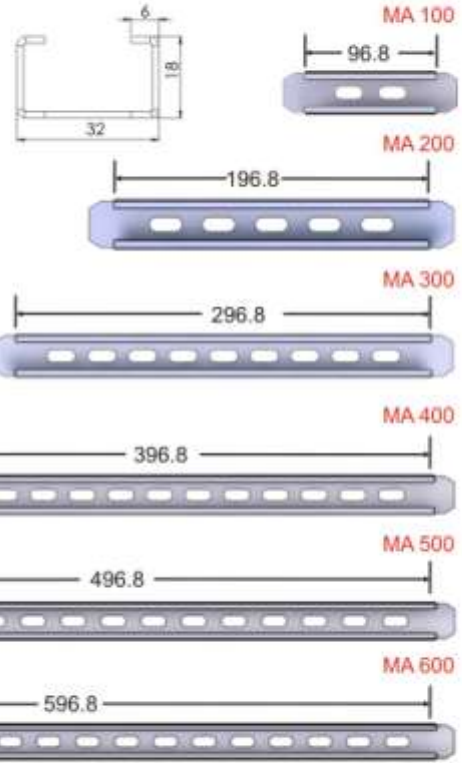

h50/h100 p.g./h.d.g. Stoktan Teslim.
h50/h100 p.g./h.d.g. Delivery From Stock.

* Standart bir boy merdiven için toplam 9 adet ara parça kullanılmaktadır.
* Merdiven montajı için montaj kılavuzunu okuyunuz.

* 9 pieces of rungs are required for a standard sized ladder.
* For installation, please read the montage instructions.

EK ELEMANLARI

Straight Connection Coupler

SİPARİŞ KODU ORDER CODE	H mm	L mm	T mm P.G.	AĞIRLIK (kg/ad) WEIGHT (kg/pc)	T mm (H.D.G.)	AĞIRLIK (kg/ad) WEIGHT (kg/pc)	
A1-05-12-140	50	140	1.2	0.075	1.5	0.095	
A1-07-12-140	70	140	1.2	0.095	1.5	0.120	
A1-75-12-140	75	140	1.2	0.100	1.5	0.125	
A1-08-12-140	80	140	1.2	0.110	1.5	0.140	
A1-10-12-140	100	140	1.2	0.130	1.5	0.160	
A1-12-12-140	125	140	1.2	0.160	1.5	0.195	
A1-15-12-140	150	140	1.2	0.190	1.5	0.240	

h50/h100 p.g./h.d.g. Stoktan Teslim.
h50/h100 p.g./h.d.g. Delivery From Stock.

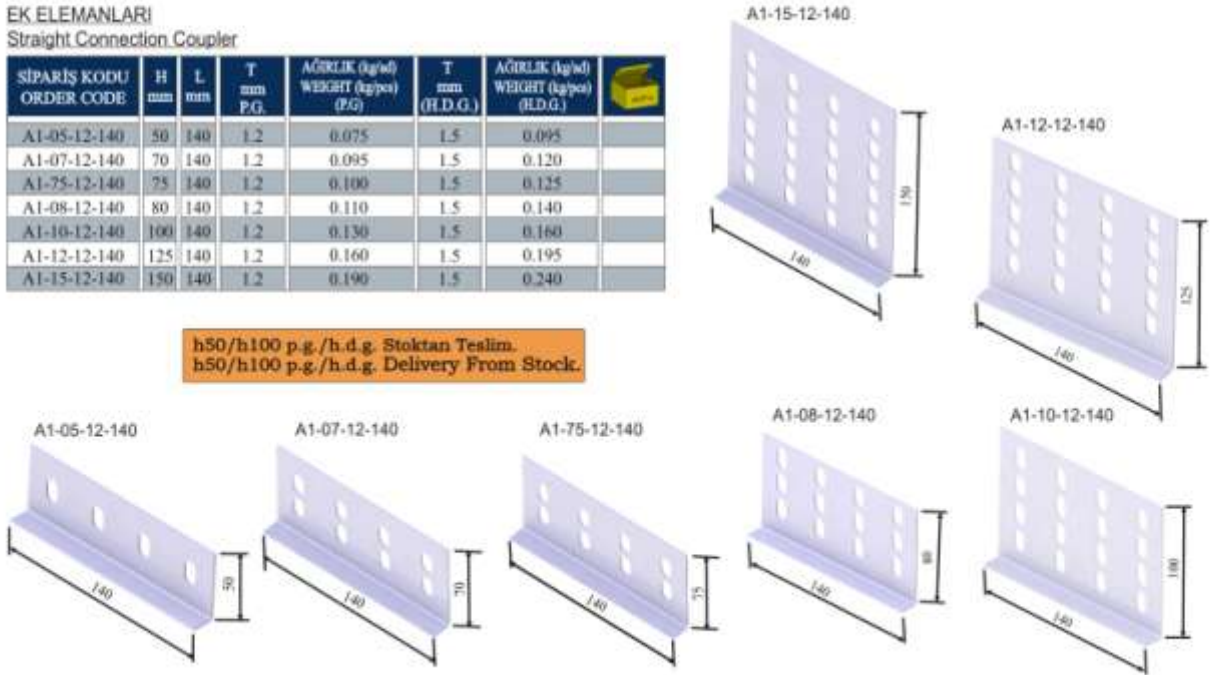

Maximum kablo kalınlığı: ± %10
Material thickness tolerance: ± %10

KABLO MERDİVENİ ÖZEL ARA BASAMAKLAR

Cable Ladder Special Rungs

SİPARİŞ KODU ORDER CODE	L mm	T mm (P.G.)	AĞIRLIK (kg/ad) WEIGHT (kg/pc)	T mm (H.D.G.)	AĞIRLIK (kg/ad) WEIGHT (kg/pc)	
MA 150	150	1.2	0.110	1.5	0.160	
MA 250	250	1.2	0.180	1.5	0.265	
MA 350	350	1.2	0.250	1.5	0.365	
MA 450	450	1.2	0.320	1.5	0.465	
MA 550	550	1.2	0.390	1.5	0.565	
MA 650	650	1.2	0.510	1.5	0.705	
MA 700	700	1.2	0.545	1.5	0.750	
MA 750	750	1.2	0.585	1.5	0.805	
MA 800	800	1.2	0.625	1.5	0.860	
MA 850	850	1.2	0.660	1.5	0.910	
MA 900	900	1.2	0.700	1.5	0.970	
MA 950	950	1.5	0.740	1.5	1.020	
MA 1000	1000	1.5	0.780	1.5	1.075	



MA 150



MA 250



MA 350



MA 450



MA 550



MA 650



MA 700



MA 750



MA 800



MA 850



MA 900



MA 950



MA 1000



150-250-350-450-550 Teknik Detaylar
150-250-350-450-550 Technical Details

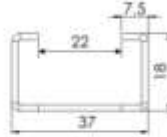

650-700-750-800-850-900-950-1000 Teknik Detaylar
650-700-750-800-850-900-950-1000 Technical Details

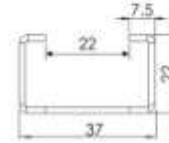

- 1.) Kullanıma uygun yan kenarlar seçilir.
1.) Suitable side rails should be chosen.

- 2.) Kullanıma uygun ara basamaklar seçilir.
2.) Suitable (needed) rungs should be chosen.

Stoklarda H50 ve H100 merdiven bulunmaktadır.
H:50 mm & H:100 mm ladders are always in stock.

Sipariş halinde H70 H75 H80 H125 H150
merdiven yan kenarları ve ara basamaklar üretilebilmektedir.
We are able to produce H:70 mm, H:75 mm, H:80 mm, H:125 mm and H:150 mm
height of cable ladders and rungs on request.



Rungs

100 mm



200 mm



300 mm



400 mm



500 mm



600 mm



- 3.) Ara basamaklar yan kenarlardaki yerlerine takılır.
3.) Rungs are put in their places on side rails.

- 4.) Plastik Tokmak Yardımı ile ara basamak kulakları yukarıya doğru bükülür.
4.) The sides of rungs are bended upwards with plastic hammer.

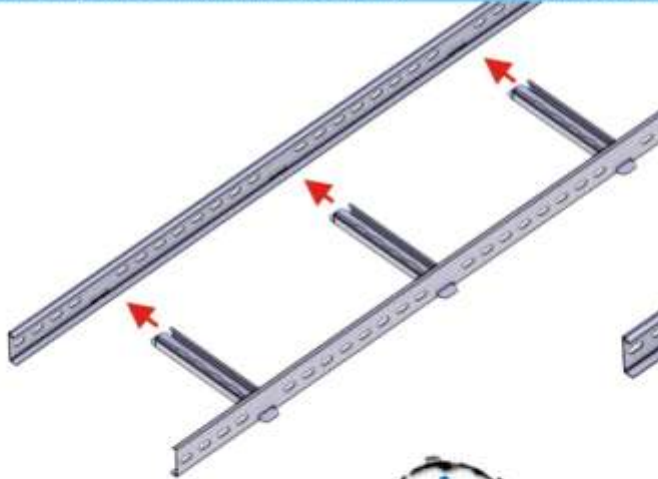

Büküm yaparken plastik çekiç kullanınız.
Demir çekiç merdivenin kaplamasına zarar verebilir.
Please use plastic hammer while bending process.
Iron hammer may damage coating on ladders.