

# Terminal Solutions



Get Familiar With Linkwell  
Products Online:  
[www.linkwell.org](http://www.linkwell.org)



Innovation-Quality-Global

## INTRODUCTION

We are mainly dealing with low voltage electrical products for switchgear board and automation industry, such as panel filter and fans, panel heaters, thermostats and hygostats , wiring accessories, etc. Through our decades' efforts and developments now LINKWELL become a group company with several factories by entirely holding or partly holding , not only self production but also few trading, in order to provide one- stop-solution for panel builders.

Our main markets are European countries, Americans and China market. You can find us in more than 60 countries all over the world, well-known with very good reputation in the market for the sake of our good quality and competitive prices, kind and prompt services to clients.

LINKWELL ELECTRIC policy is to offer a full support to Clients:

- pre-after sales assistance
- customized products
- fast delivery
- monitoring of customers' satisfaction

Rather than a supplier, LINKWELL ELECTRIC aims to be a Client's industrial PARTNER!

Our company always pays special attention to protecting the benefits of clients' so that both the clients and our company are able to gain the maximum benefits from the relations between us.

We warmly look forward to establishing, reinforcing and expanding long term fruitful relationship with the reliable clients all over the world.

Let's get busy and pull together to create a better future!



# CONTENTS

---



Distribution Terminal Blocks *01-16*

---



KE Universal Terminal *17-26*

---



LUK Terminal Connection *27-36*

---



Cabinet Accessories *37-49*

---



Lamp for Cabinet *50-66*

---



Wiring Duct *67-77*

---



Relay Module *78-86*

---



Transformer *87-96*

---



Push Button & Indicator *97-102*

---



Cable Entry Systems *103-125*

---



Shield Clamps *126-136*

---





- Space saving: compact
- Tinned copper block: high conductivity
- IP 20 protection/UL finger-safe: improved safety
- Cable fixing screw diameters >95% fill ratio: excellent electrical contact, safe connections
- Visual inspection of wire: confirmation of connection
- Hinged or removable cover: easy wiring
- Clip-on DIN rail or mount to panel with screws: easy fixing

## Attachment



LK 80 A



LK-80A CE RoHS

80A IEC 60947-7-1

85 Amp ( UL certification application )

Modular:keeping only one input,the blocks can be connected in parallel using a jumper wire. Easily double or triple the neutral.

Metric system	mm <sup>2</sup>			I(N.m)
	6...16	x1		3.5
	2.5...6	x4		1.2
	2.5...16	x2		3.5

U.S. Regulations	AWG			Torque
	16...4	x1		19.5
	16...8	x4		10.6
	16...4	x2		19.5

- I=80 A IEC
- I=85 A UL/CSA
- l<sub>cw</sub> KA rms Is: 3
- IPk KA: 22
- Ui: 690V IEC
- Vin: 600 V UL



Installation Hole:54mm

LK 125 A



LK-125A CE RoHS

125A IEC 60947-7-1

150 Amp ( UL certification application )

Modular:keeping only one input,the blocks can be connected in parallel using a jumper wire. Easily double or triple the neutral.

Metric system	mm <sup>2</sup>			I(N.m)
	10...35	x1		8.5
	6...16**	x1		3.5
	2,5...16	x6  x4		3.5

\*\* or common jumper

U.S. Regulations	AWG			Torque
	8...1/0	x1		57
	14...4	x1		31
	14...4	x6		31

- I=125 A IEC
- I=150 A UL/CSA
- l<sub>cw</sub> KA rms Is: 4.2
- IPk KA: 30
- Ui: 690V IEC
- Vin: 600 V UL

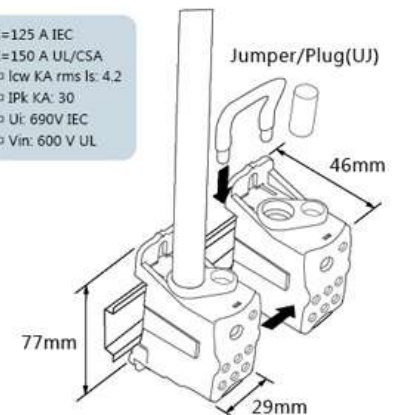

Installation Hole:64mm

LK 160 A



LK-160A CE RoHS

160A IEC 60947-7-1

200 Amp ( UL certification application )

Modular:keeping only one input,the blocks can be connected in parallel using a jumper wire. Easily double or triple the neutral.

Metric system	mm <sup>2</sup>			I(N.m)
	10...70	x1		8.5
	6...16**	x1		3.5
	2,5...16	x6  x4		3.5

\*\* or common jumper

U.S. Regulations	AWG			Torque
	8...3/0	x1		75
	14...4	x1		31
	14...4	x6		31

- I=160 A IEC
- I=200 A UL/CSA
- l<sub>cw</sub> KA rms Is: 11.8
- IPk KA: 30
- Ui: 690V IEC
- Vin: 600 V UL

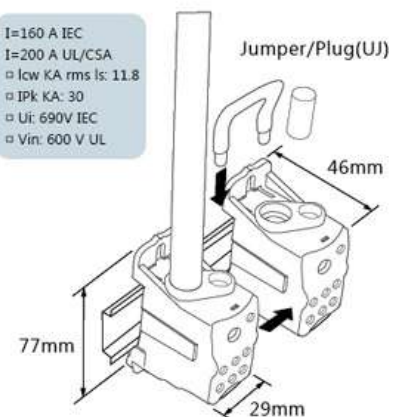

Installation Hole:64mm

LK 250 A



**LK-250A**    **CE RoHS**

**250A IEC 60947-7-1**  
**255 Amp (UL certification application)**

Modular:allows versatile building of power blocks single pole, two pole,three pole or four pole.

Metric system	mm <sup>2</sup>	mm <sup>2</sup>		T(N.m)
	35...120		x1	19
	6...35	6...25	x2	4.4
	2.5...16	2.5...16	x5	2.7
	2.5...10	2.5...10	x4	2.7

U.S. Regulations	AWG		Torque
	6...250 Kcmil	x1	221
	14...1	x2	39
	14...4	x5	24
	14...6	x4	24

- I=250 A IEC
- I=255 A UL/CSA
- Icw KA rms Is: 24.5
- IPk KA: 51
- Ui: 690V IEC
- Vin: 600 V UL

Flexible with TF 250A busbar connection with the TH

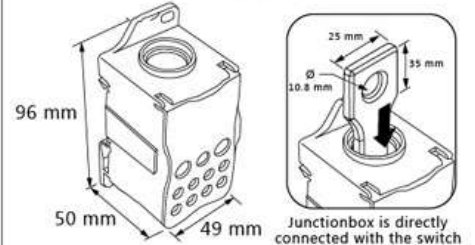

Installation Hole:85×29mm

LK 400 A



**LK-400A**    **CE RoHS Conform to**

**400A IEC 60947-7-1**  
**335 Amp (UL certification application)**

Modular:allows versatile building of power blocks single pole, two pole,three pole or four pole.

Metric system	mm <sup>2</sup>	mm <sup>2</sup>		T(N.m)
	95...185		x1	25
	6...35	6...25	x2	4.4
	2.5...16	2.5...16	x5	2.7
	2.5...10	2.5...10	x4	2.7

U.S. Regulations	AWG		Torque
	3/0...400 Kcmil	x1	221
	14...1	x2	39
	14...4	x5	24
	14...6	x4	24

- I=400 A IEC
- I=335 A UL/CSA
- Icw KA rms Is: 24.5
- IPk KA: 51
- Ui: 690V IEC
- Vin: 600 V UL

Flexible with TF 400A busbar connection with the TH

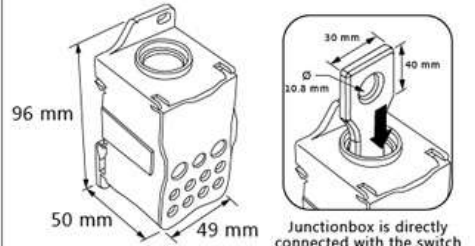

Installation Hole:85×29mm

LK 500 A



**LK-500A**    **CE RoHS**

**500A IEC 60947-7-1**  
**520 Amp (UL certification application)**

Modular:allows versatile building of power blocks single pole, two pole,three pole or four pole.

Metric system	mm <sup>2</sup>	mm <sup>2</sup>		T(N.m)
	4x15.5x0.8 ...8x24x1	4x15.5x0.8 ...8x24x1		10
	6...35	6...25	x2	4.4
	2.5...16	2.5...16	x5	2.7
	2.5...10	2.5...10	x4	2.7

U.S. Regulations	AWG		Torque
	4x15.5x0.8 ...8x24x1		88.5
	14...1	x2	39
	14...4	x5	24
	14...6	x4	24

- I=500 A IEC
- I=520 A UL/CSA
- Icw KA rms Is: 24.5
- IPk KA: 51
- Ui: 690V IEC
- Vin: 600 V UL

TH flexible busbar

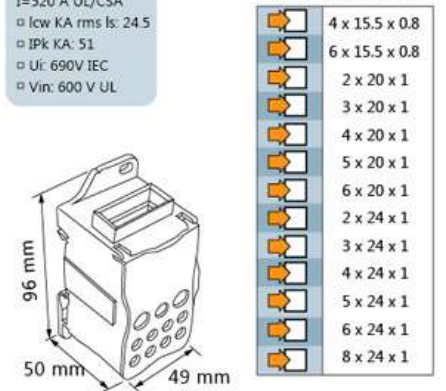

Installation Hole:85×29mm

# Distribution Terminal Blocks

## LK 207

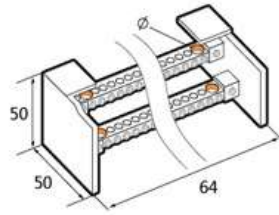

Type	Size	Terminals per pole
<b>LK207</b> Solid core lead multistrand lead [ mm* ]	L×H×W	2 pole
EN60947-1 c e	1.5-6mm <sup>2</sup> 6-16mm <sup>2</sup> 64×50×50mm	1×16mm <sup>2</sup> 1×25mm <sup>2</sup> 5×6mm <sup>2</sup>
KA rating pead Max. Current100A Voltage 500V	For	

## LK 211

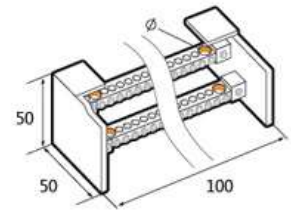
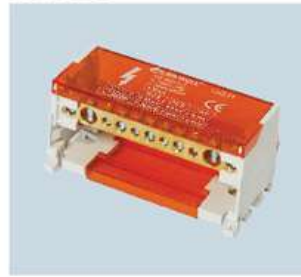

Type	Size	Terminals per pole
<b>LK211</b> Solid core lead multistrand lead [ mm* ]	L×H×W	2 pole
EN60947-1 c e	1.5-6mm <sup>2</sup> 6-16mm <sup>2</sup> 10-16mm <sup>2</sup> 10-25mm <sup>2</sup> 10-35mm <sup>2</sup> 100×50×50mm	3×16mm <sup>2</sup> 1×25mm <sup>2</sup> 7×6mm <sup>2</sup>
KA rating pead Max. Current100A Voltage 500V	For	

## LK 215

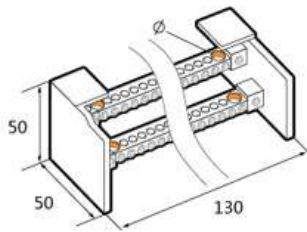

Type	Size	Terminals per pole
<b>LK215</b> Solid core lead multistrand lead [ mm* ]	L×H×W	2 pole
EN60947-1 c e	1.5-6mm <sup>2</sup> 6-16mm <sup>2</sup> 10-25mm <sup>2</sup> 2.5-6mm <sup>2</sup> 10-35mm <sup>2</sup> 130×50×50mm	3×16mm <sup>2</sup> 1×25mm <sup>2</sup> 11×6mm <sup>2</sup>
KA rating pead Max. Current100A Voltage 500V	For	

## LK 407

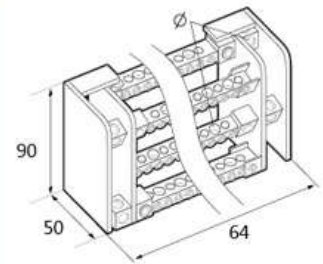
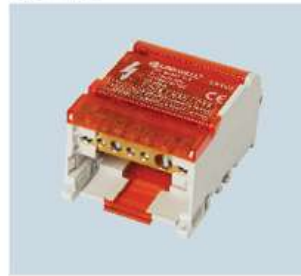

Type	Size	Terminals per pole
<b>LK407</b> Solid core lead multistrand lead [ mm* ]	L×H×W	4 pole
EN60947-1 c e	1.5-6mm <sup>2</sup> 6-16mm <sup>2</sup> 2.5-6mm <sup>2</sup> 10-25mm <sup>2</sup> 64×50×90mm	1×16mm <sup>2</sup> 1×25mm <sup>2</sup> 5×6mm <sup>2</sup>
KA rating pead Max. Current100A Voltage 500V	For	

## LK 411

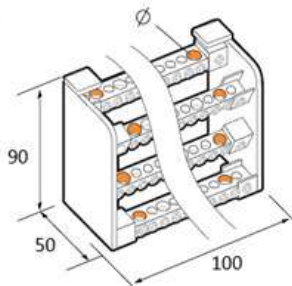

Type	Size	Terminals per pole
<b>LK411</b> Solid core lead multistrand lead [ mm* ]	L×H×W	4 pole
EN60947-1 c e	1.5-6mm <sup>2</sup> 6-16mm <sup>2</sup> 10-16mm <sup>2</sup> 10-25mm <sup>2</sup> 10-35mm <sup>2</sup> 100×50×90mm	3×16mm <sup>2</sup> 1×25mm <sup>2</sup> 7×6mm <sup>2</sup>
KA rating pead Max. Current100A Voltage 500V	For	

## LK 415

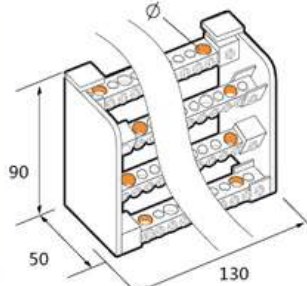

Type	Size	Terminals per pole
<b>LK415</b> Solid core lead multistrand lead [ mm* ]	L×H×W	4 pole
EN60947-1 c e	1.5-6mm <sup>2</sup> 6-16mm <sup>2</sup> 10-25mm <sup>2</sup> 2.5-6mm <sup>2</sup> 10-35mm <sup>2</sup> 130×50×90mm	3×16mm <sup>2</sup> 1×25mm <sup>2</sup> 11×6mm <sup>2</sup>
KA rating pead Max. Current100A Voltage 500V	For	

## UK 207

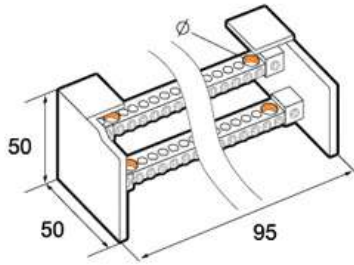

Type	Size	Terminals per pole
<b>UK 207</b>	Solid core lead multistrand lead [ mm <sup>2</sup> ]	2 pole
EN60947-1 CE Certificate	1.5-6mm <sup>2</sup> 6-16mm <sup>2</sup>	1 x 16mm <sup>2</sup> 1 x 25mm <sup>2</sup> 5 x 6mm <sup>2</sup>
KA rating pead Max. Current 125A	Voltage 500V	For  type

## UK 211

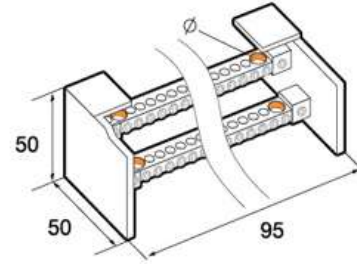

Type	Size	Terminals per pole
<b>UK 211</b>	Solid core lead multistrand lead [ mm <sup>2</sup> ]	2 pole
EN60947-1 CE Certificate	1.5-6mm <sup>2</sup> 6-16mm <sup>2</sup> 10-16mm <sup>2</sup> 10-25mm <sup>2</sup> 10-35mm <sup>2</sup>	3 x 16mm <sup>2</sup> 1 x 25mm <sup>2</sup> 7 x 6mm <sup>2</sup>
KA rating pead Max. Current 125A	Voltage 500V	For  type

## UK 215

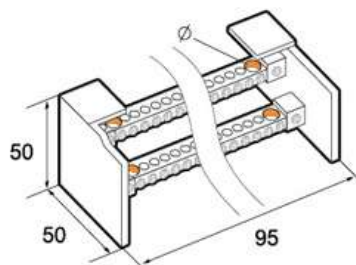

Type	Size	Terminals per pole
<b>UK 215</b>	Solid core lead multistrand lead [ mm <sup>2</sup> ]	2 pole
EN60947-1 CE Certificate	1.5-6mm <sup>2</sup> 6-16mm <sup>2</sup> 10-25mm <sup>2</sup> 2.5-6mm <sup>2</sup> 10-35mm <sup>2</sup>	3 x 16mm <sup>2</sup> 1 x 25mm <sup>2</sup> 11 x 6mm <sup>2</sup>
KA rating pead Max. Current 125A	Voltage 500V	For  type

## UK 407

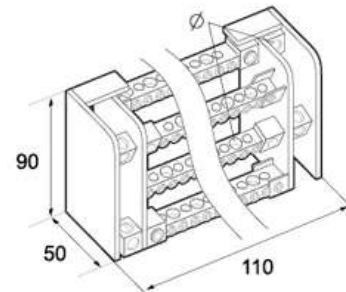

Type	Size	Terminals per pole
<b>UK 407</b>	Solid core lead multistrand lead [ mm <sup>2</sup> ]	4 pole
EN60947-1 CE Certificate	1.5-6mm <sup>2</sup> 6-16mm <sup>2</sup> 2.5-6mm <sup>2</sup> 10-25mm <sup>2</sup>	1 x 16mm <sup>2</sup> 1 x 25mm <sup>2</sup> 5 x 6mm <sup>2</sup>
KA rating pead Max. Current 125A	Voltage 500V	For  type

# Distribution Terminal Blocks

## UK 411

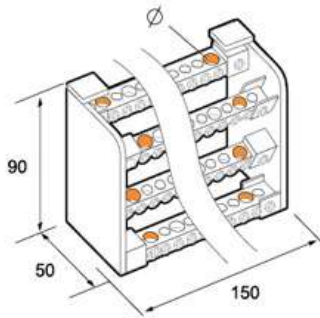

Type	Solid core lead multistrand lead [ mm <sup>2</sup> ]	Size L H W	Terminals per pole
<b>UK 411</b>			4 pole
EN60947-1 CE Certificate	1.5-6mm <sup>2</sup> 10-16mm <sup>2</sup> 6-16mm <sup>2</sup> 10-25mm <sup>2</sup> 10-35mm <sup>2</sup>	147x50 x85mm	3 x 16mm <sup>2</sup> 1 x 25mm <sup>2</sup> 7 x 6mm <sup>2</sup>
KA rating pead Max. Current	125A Voltage 500V	For  type	

## UK 412

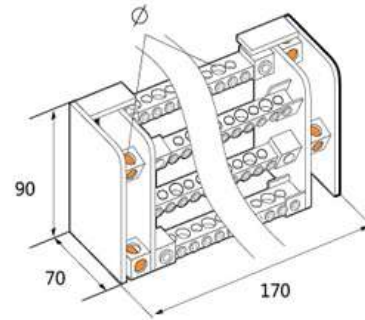

Type	Solid core lead multistrand lead [ mm <sup>2</sup> ]	Size L H W	Terminals per pole
<b>UK 412</b>			4 pole
EN60947-1 CE Certificate	1.5-6mm <sup>2</sup> 10-16mm <sup>2</sup> 6-16mm <sup>2</sup> 2.5-6mm <sup>2</sup> 10-35mm <sup>2</sup>	170x70 x90mm	3 x 16mm <sup>2</sup> 1 x 25mm <sup>2</sup> 7 x 6mm <sup>2</sup>
KA rating pead Max. Current	160A Voltage 500V	For  type	

## UK 415

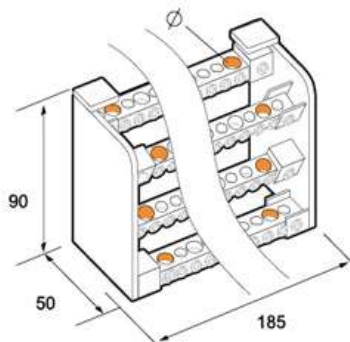

Type	Solid core lead multistrand lead [ mm <sup>2</sup> ]	Size L H W	Terminals per pole
<b>UK 415</b>			4 pole
EN60947-1 CE Certificate	1.5-6mm <sup>2</sup> 10-25mm <sup>2</sup> 6-16mm <sup>2</sup> 2.5-6mm <sup>2</sup> 10-35mm <sup>2</sup>	182x50 x85mm	3 x 16mm <sup>2</sup> 1 x 25mm <sup>2</sup> 11 x 6mm <sup>2</sup>
KA rating pead Max. Current	125A Voltage 500V	For  type	

## Neutral wire 125A/160A

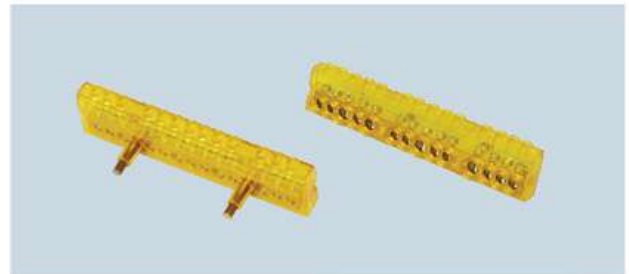

- Improved wire connectivity
- Direct electrical connection
- Reliable and safe mounting
- Transparent cover

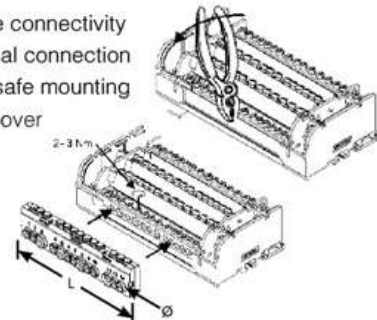

### NB 125 A

- I = 125 A IEC
- I<sub>cw</sub> kA rms 1s : 4,5
- I<sub>pk</sub> kA : 30

				Ø		Γ (N.m)
	10-25	6-16	x3	7,5		2-3
	2,5-6	1,5-6	x9	5,5		2-3

### NB 160 A

- I = 160 A IEC
- I<sub>cw</sub> kA rms 1s : 6,2
- I<sub>pk</sub> kA : 35

				Ø		Γ (N.m)
	10-35	10-25	x4	8,5		2-3
	2,5-16	1,5-16	x10	7,2		2-3

## Simple and Compact DB Power distribution blocks

- Small and space-saving
- Modular architecture, enable three phase modules
- User-friendly
- IP20 protection degree
- Clip-on NS35 DIN rail, or mount to panel sheet with screw
- Short-circuit Protection
- Each module allows cable feed -through Max. 5×16mm

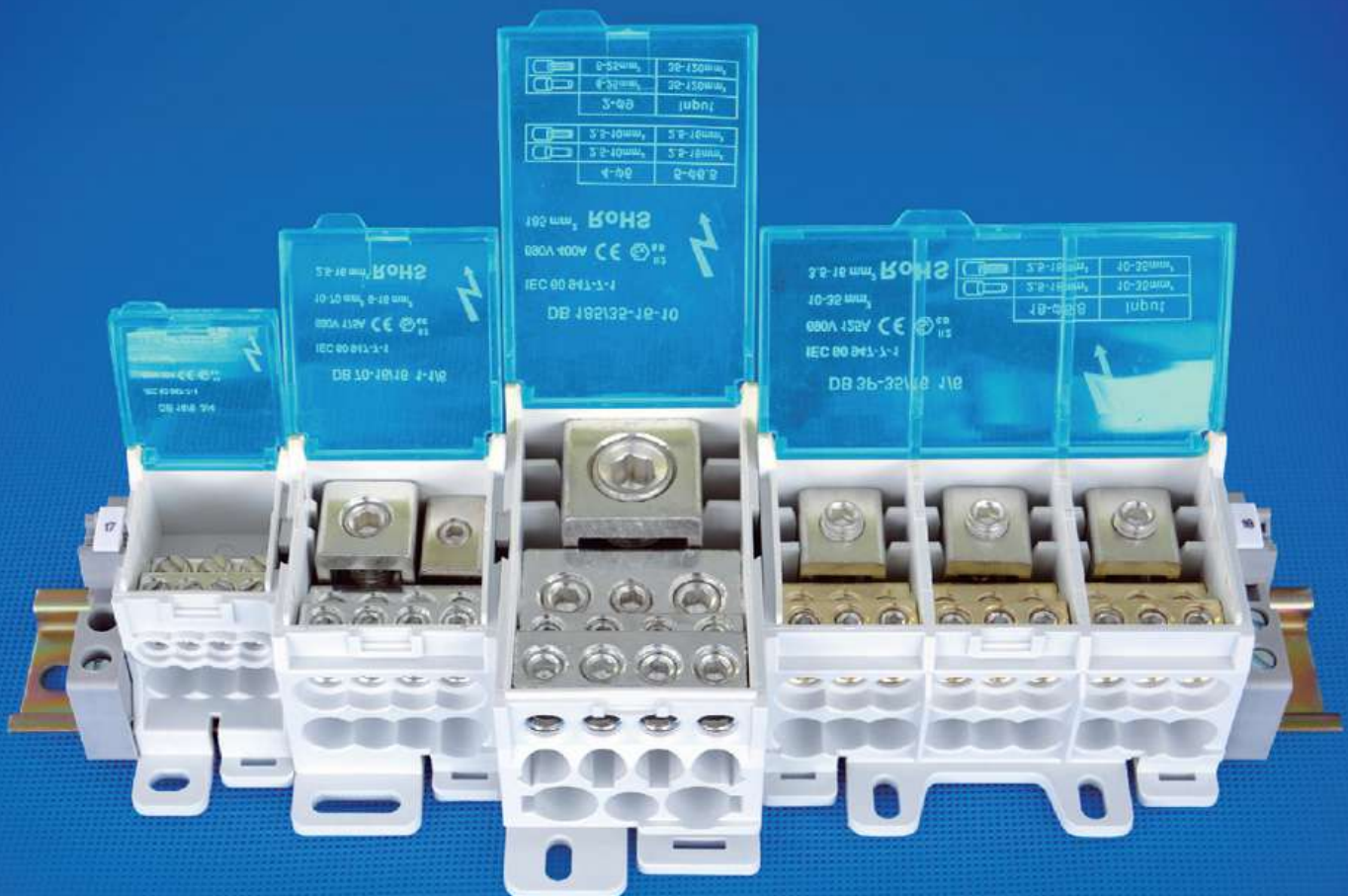

Single pole distribution block

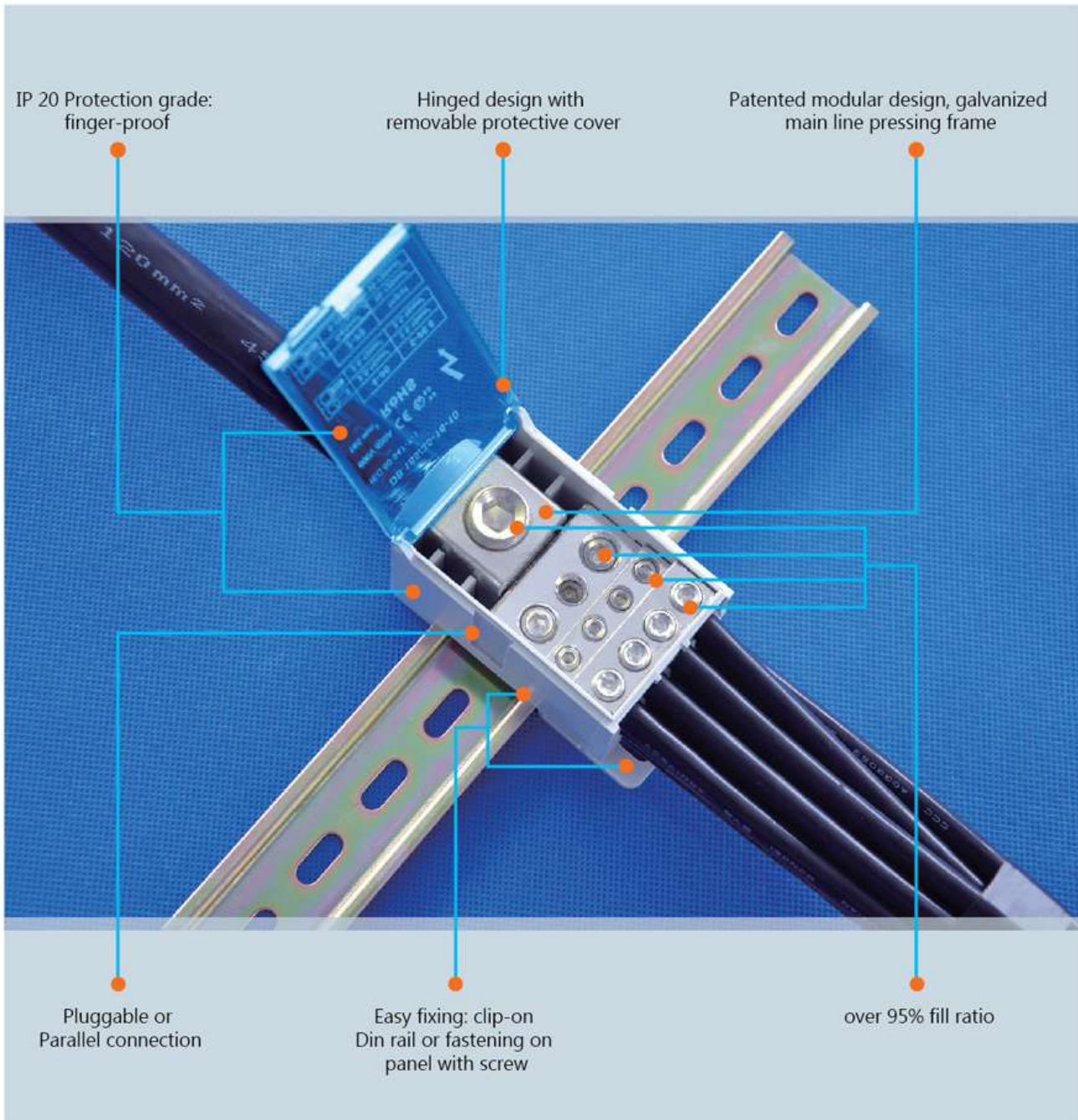

Terminal Connection

Input cable connection mode

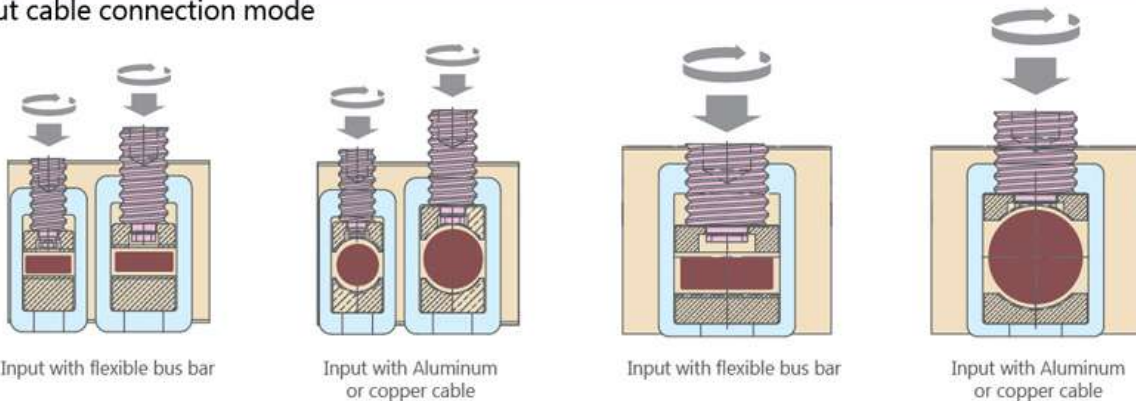



Specification	DB 16/6 3/4				DB 35-16/16 1-1/8			
Max. Current(A)	80A				125A			
Dimensions(mm)	Specification				Specification			
	Length	Thickness	Height	NS 35:7.5	Length	Thickness	Height	NS 35:7.5
Length/Thickness/Height NS 35:7.5/NS 35:15	★ 66	30.2	48		75	40	50	
According to the standard IEC 60 947-7-1 parameters								
Rated voltage(V)	V	690			690			
Rated current (A)	A	80			125			
Input/output cable rated cable Cross-section	(mm <sup>2</sup> )	16/16-6			35-16/16			
Rated impulse voltage/ The pollution grade		2.5kV/3			2.5kV/3			
UL94 Flammability class		V-0			V-0			
More data								
Peak value of short-current		22			30			
short current >1 S		3			4.2			
Input	A	B			A	B	C	
Input cable terminal quantity	1				1	1		
"e"Single stranded solid wire H07V-U	(mm <sup>2</sup> )	2.5...16			10...35		6...16	
"m"Multi-stranded solid wire H07V-R	(mm <sup>2</sup> )	2.5...16			10...35		6...16	
"f"flexible bus bar H07V-K	(mm <sup>2</sup> )	2.5...16			10...35		6...16	
"f"flexible with wire-end ferrules acc. DIN46228-1 H07V-R	(mm <sup>2</sup> )	2.5...16			10...35		6...16	
"f"flexible with wire-end ferrules acc. DIN46228-1, with plastic collars H07V-R	(mm <sup>2</sup> )	2.5...16			10...35		6...16	
Dia.	mm	6.8			10		6.8	
Tightening Torque	(Nm)	1.5...3			3.5...5		1.5...3	
Compression screw type		M6			M8		M6	
Stripping length	(mm)	9...12			14-15		9-12	
Screwdriver blade Size		SZS 1.0×6.5			SK-S 4.0		SK-S 3.0	
Output	A	B			A			
Output cable terminal quantity	3	4			8			
"e"Single stranded solid wire H07V-U	(mm <sup>2</sup> )	2.5...16		2.5...6	2.5...16			
"m"Multi-stranded solid wire H07V-R	(mm <sup>2</sup> )	2.5...16		2.5...6	2.5...16			
"f"flexible bus bar H07V-K	(mm <sup>2</sup> )	2.5...16		2.5...6	2.5...16			
"f"flexible bus bar with wire-end ferrules acc. DIN46228-1 H07V-R	(mm <sup>2</sup> )	2.5...16		2.5...6	2.5...16			
"f"flexible bus bar with wire-end ferrules acc. DIN46228-1, with plastic collars H07V-R	(mm <sup>2</sup> )	2.5...16		2.5...6	2.5...16			
Dia.	mm	6.8		4.5	6.8			
Tightening Torque	(Nm)	1.5...3		0.8...1.5	1.5...3			
Compression screw type		M6		M5	M6			
Stripping length	(mm)	9...12		9...12	10...12			
Screwdriver blade Size/Inner hexagonal spanner		SZS 1.0×6.5		SZS 1.0×4.0	SK-S 3.0			
UL/CSA parameter								
Voltage/current/cable size	UL							
Voltage/current/cable size	CSA							

Product Description.	color	Model No.	Packing	Code No.	Model No.	Packing	Code No.
W/Aluminum or copper cable input	PA WH	DB16/6 3/4	1	8601001	DB 35-16/16 1-1/8	1	8602001
		DB16/6 3/4	1	8601002	DB 35-16/16 1-1/8	1	8602002
W/ Flexible bus bar input	PA GY				DB 35-16/16 1-1/8	1	8602003
					DB 35-16/16 1-1/8	1	8602004

Attachment	screw driver	Model No.	Code No.	Model No.	Code No.
	Slotted	SZS 1.0×4.0	8601011		
	Slotted	SZS 1.0×6.5	8601012	SK-S 3.0	8601021
	Inner Hexagonal spanner7pcs set	SK-S 3.0-8.0		SK-S 4.0	8601022

# DB POWER DISTRIBUTION TERMINALS



## DB 70-16/16 1-1/8

175A

### Specification

Length Thickness Height NS 35:7.5

75 40 50

690

175

70-16/16

2.5KV/3

V-0

30

11.8

A B

1 1

16...70 6...16

16...70 6...16

16...70 6...16

16...70 6...16

16...70 6...16

12 6.8

5 1.5...3

M10 M6

15-16 9-12

SK-S 5.0 SK-S 3.0

A

10

2.5...16

2.5...16

2.5...16

2.5...16

2.5...16

6.8

1.5...3

M6

10...12

SK-S 3.0

Model No. Packing Code No.

DB 70-16/6 1-1/8 1 8603001

DB 70-16/6 1-1/8 1 8603002

DB 70-16/6 1-1/8 1 8603003

DB 70-16/6 1-1/8 1 8603004

Model No. Code No.

SK-S 3.0 8601021

SK-S 5.0 8601023

## DB 16/6 3/4

Metric	mm <sup>2</sup>		Ø		N.m
	2.5...16	×1	6.8		3.0
	2.5...6	×4	4.5		1.5
	2.5...16	×2	6.8		3.0

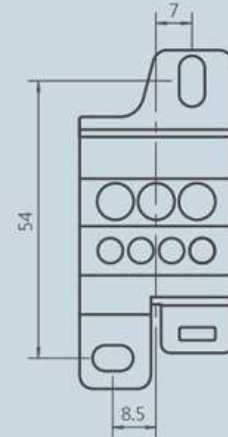

## DB 35-16/6 1-1/8

W/Aluminum or copper cable input

Metric	mm <sup>2</sup>		Ø		N.m
	10...35	×1			5.0
	6...16	×1	6.8		3.0
	2.5...16	×8	6.8		3.0

W/ Flexible bus bar input

W/ Flexible bus bar input end	
9×3×0.8 - 9×6×0.8	

Metric	mm <sup>2</sup>		Ø		N.m
	10...35	×1			5.0
	6...16	×1	6.8		3.0
	2.5...16	×8	6.8		3.0

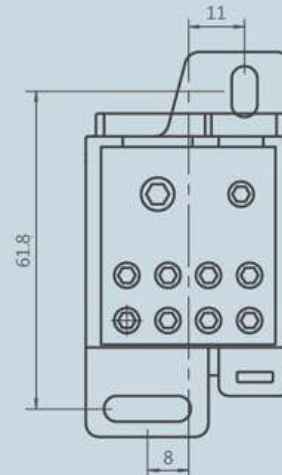

## DB 70-16/6 1-1/8

W/Aluminum or copper cable input

Metric	mm <sup>2</sup>		Ø		N.m
	16...70	×1			5.0
	6...16	×1	6.8		3.0
	2.5...16	×8	6.8		3.0

W/ Flexible bus bar input

W/ Flexible bus bar input end	
13×3×0.5 - 13×6×0.5	

Metric	mm <sup>2</sup>		Ø		N.m
	16...70	×1			5.0
	6...16	×1	6.8		3.0
	2.5...16	×8	6.8		3.0

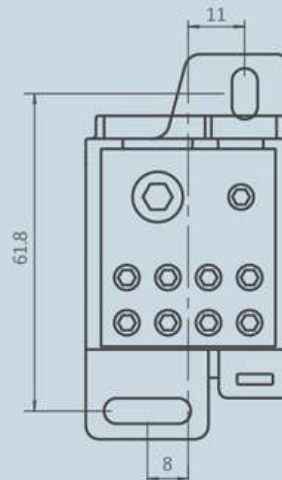





Specification	DB 120/35-16-10 1/2-5-4				DB 185/35-16-10 1/2-5-4			
Max. Current(A)	250A				400A			
Dimensions(mm)	Specification				Specification			
	Length	Thickness	Height	NS 35:7.5	Length	Thickness	Height	NS 35:7.5
Length/Thickness/Height NS 35:7.5/NS 35:15	★ 96	46.8	51.5		96	46.8	51.5	
According to the standard IEC 60 947-7-1 parameters								
Rated voltage(V)	V	690			690			
Rated current (A)	A	250			400			
Input/output cable rated cable Cross-section (mm <sup>2</sup> )	120/35-16-10				185/35-16-10			
Rated impulse voltage/ The pollution grade	2.5kV/3				2.5kV/3			
UL94 Flammability class	V-0				V-0			
More data								
Peak value of short-current	51				51			
short current >1 S	24.5				24.5			
Input	A				A			
Input cable terminal quantity	1				1			
"e"Single stranded solid wire H07V-U (mm <sup>2</sup> )	35...120				95...185			
"m"Multi-stranded solid wire H07V-R (mm <sup>2</sup> )	35...120				95...185			
"f"flexible bus bar H07V-K (mm <sup>2</sup> )	35...120				95...185			
"f"flexible with wire-end ferrules acc. DIN46228-1 H07V-R (mm <sup>2</sup> )	35...120				95...185			
"f"flexible with wire-end ferrules acc. DIN46228-1, with plastic collars H07V-R (mm <sup>2</sup> )	35...120				95...185			
Dia. (mm)	15				19			
Tightening Torque (Nm)	19				25			
Compression screw type	M12				M16			
Stripping length (mm)	27...29				27...29			
Screwdriver blade Size	SK-S 6.0				SK-S 8.0			
Output	A	B	C		A	B	C	
Output cable terminal quantity	2	5	4		2	5	4	
"e"Single stranded solid wire H07V-U (mm <sup>2</sup> )	2.5...35	2.5...16	2.5...10		2.5...35	2.5...16	2.5...10	
"m"Multi-stranded solid wire H07V-R (mm <sup>2</sup> )	2.5...35	2.5...16	2.5...10		2.5...35	2.5...16	2.5...10	
"f"flexible bus bar H07V-K (mm <sup>2</sup> )	2.5...35	2.5...16	2.5...10		2.5...35	2.5...16	2.5...10	
"f"flexible bus bar with wire-end ferrules acc. DIN46228-1 H07V-R (mm <sup>2</sup> )	2.5...35	2.5...16	2.5...10		2.5...35	2.5...16	2.5...10	
"f"flexible bus bar with wire-end ferrules acc. DIN46228-1, with plastic collars H07V-R (mm <sup>2</sup> )	2.5...35	2.5...16	2.5...10		2.5...35	2.5...16	2.5...10	
Dia. (mm)	9	6.8	6.1		9	6.8	6.1	
Tightening Torque (Nm)	3.5	2	2		3.5	2	2	
Compression screw type	M10	M6	M5		M10	M6	M5	
Stripping length (mm)	10...12	10...12	10...12		10...12	10...12	10...12	
Screwdriver blade Size/Inner hexagonal spanner	SK-S 5.0	SK-S 4.0	SK-S 3.0		SK-S 5.0	SK-S 4.0	SK-S 3.0	
UL/CSA parameter								
Voltage/current/cable size	UL							
Voltage/current/cable size	CSA							
Product Description.	color	Model No.	Packing	Code No.	Model No.	Packing	Code No.	
W/Aluminum or copper cable input	PA WH	DB 120/35-16-10 1/2-5-4	1	8604001	DB 185/35-16-10 1/2-5-4	1	8605001	
		DB 120/35-16-10 1/2-5-4	1	8604002	DB 185/35-16-10 1/2-5-4	1	8605002	
W/ Flexible bus bar input	PA GY	DB 120/35-16-10 1/2-5-4	1	8604003	DB 185/35-16-10 1/2-5-4	1	8605003	
		DB 120/35-16-10 1/2-5-4	1	8604004	DB 185/35-16-10 1/2-5-4	1	8605004	
Attachment	screw driver	Model No.	Code No.		Model No.	Code No.		
		SK-S 3.0	8601021		SK-S 3.0	8601021		
	Inner Hexagonal spanner 6 pcs set	SK-S 4.0	8601022		SK-S 4.0	8601022		
		SK-S 5.0	8601023		SK-S 5.0	8601023		
		SK-S 6.0	8601024		SK-S 8.0	8601025		



## DB 120/35-16-10 1/2-5-4



W/Aluminum or copper cable input

Metric	 $\text{mm}^2$	$\times$	$\varnothing$	N.m
 35...120	$\times 1$			19
 2.5...35	$\times 2$	9		3.5
 2.5...16	$\times 5$	6.8		2
 2.5...10	$\times 4$	6.1		2

W/ Flexible bus bar input

W/ Flexible bus bar input end

15.5×2×0.8 - 15.5×6×0.8

Metric	 $\text{mm}^2$	$\times$	$\varnothing$	N.m
 35...120	$\times 1$			19
 2.5...35	$\times 2$	9		3.5
 2.5...16	$\times 5$	6.8		2
 2.5...10	$\times 4$	6.1		2

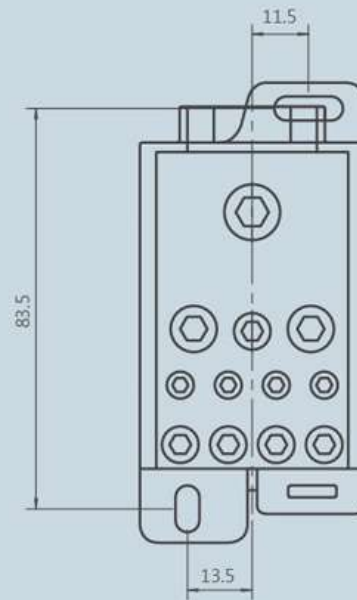

## DB 185/35-16-10 1/2-5-4





W/Aluminum or copper cable input

Metric	 $\text{mm}^2$	$\times$	$\varnothing$	N.m
 95...185	$\times 1$			25
 2.5...35	$\times 2$	9		3.5
 2.5...16	$\times 5$	6.8		2
 2.5...10	$\times 4$	6.1		2

W/ Flexible bus bar input

W/ Flexible bus bar input end

20×2×1.0 - 20×6×1.0

Metric	 $\text{mm}^2$	$\times$	$\varnothing$	N.m
 95...185	$\times 1$			25
 2.5...35	$\times 2$	9		3.5
 2.5...16	$\times 5$	6.8		2
 2.5...10	$\times 4$	6.1		2

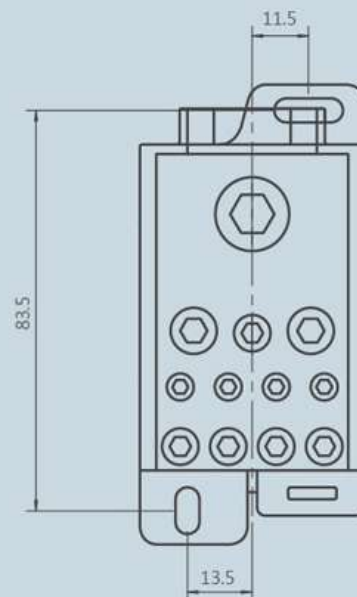







Specification	DB 3P-35/16 1/6	DB 3P-70/16 1/6
Max. Current(A)	125A	175A
Dimensions(mm)	Specification	Specification
	Length Thickness Height NS 35:7.5	Length Thickness Height NS 35:7.5
Length/Thickness/Height NS 35:7.5/NS 35:15	★ 75.5 85 50	75.5 85 50
According to the standard IEC 60 947-7-1 parameters		
Rated voltage(V)	V 690	690
Rated current (A)	A 125	175
Input/output cable rated cable Cross-section (mm <sup>2</sup> )	3×35/16	3×70/16
Rated impulse voltage/ The pollution grade	2.5kV/3	2.5kV/3
UL94 Flammability class	V-0	V-0
More data		
Peak value of short-current short current >1 S	30 11.8	51 24.5
Input	A	A
Input cable terminal quantity	3×1	3×1
*e*Single stranded solid wire H07V-U (mm <sup>2</sup> )	10...35	16...70
*m*Multi-stranded solid wire H07V-R (mm <sup>2</sup> )	10...35	16...70
*f*flexible bus bar H07V-K (mm <sup>2</sup> )	10...35	16...70
*f*flexible with wire-end ferrules acc. DIN46228-1 H07V-R (mm <sup>2</sup> )	10...35	16...70
*f*flexible with wire-end ferrules acc. DIN46228-1, with plastic collars H07V-R (mm <sup>2</sup> )	10...35	16...70
Dia. (mm)	10	12
Tightening Torque (Nm)	1.5...5	5
Compression screw type	M8	M10
Stripping length (mm)	14...15	15...16
Screwdriver blade Size	SK-S 4.0	SK-S 5.0
Output	A	A
Output cable terminal quantity	3×6	3×6
*e*Single stranded solid wire H07V-U (mm <sup>2</sup> )	2.5...16	2.5...16
*m*Multi-stranded solid wire H07V-R (mm <sup>2</sup> )	2.5...16	2.5...16
*f*flexible bus bar H07V-K (mm <sup>2</sup> )	2.5...16	2.5...16
*f*flexible bus bar with wire-end ferrules acc. DIN46228-1 H07V-R (mm <sup>2</sup> )	2.5...16	2.5...16
*f*flexible bus bar with wire-end ferrules acc. DIN46228-1, with plastic collars H07V-R (mm <sup>2</sup> )	2.5...16	2.5...16
Dia. (mm)	6.1	6.1
Tightening Torque (Nm)	3	3
Compression screw type	M6	M6
Stripping length (mm)	10...12	10...12
Screwdriver blade Size/Inner hexagonal spanner	SK-S 3.0	SK-S 3.0
UL/CSA parameter		
Voltage/current/cable size	UL	
Voltage/current/cable size	CSA	

Product Description.	color	Model No.	Packing	Code No.	Model No.	Packing	Code No.
W/Aluminum or copper cable input	PA WH	DB 3P-35/16 1/6	1	8606001	DB 3P-70/16 1/6	1	8607001
		DB 3P-35/16 1/6	1	8606002	DB 3P-70/16 1/6	1	8607002
W/ Flexible bus bar input	PA GY	DB 3P-35/16 1/6	1	8606003	DB 3P-70/16 1/6	1	8607003
		DB 3P-35/16 1/6	1	8606004	DB 3P-70/16 1/6	1	8607004

Attachment	screw driver	Model No.	Code No.	Model No.	Code No.
Inner Hexagonal spanner 6 pcs set		SK-S 3.0	8601021	SK-S 3.0	8601021
		SK-S 4.0	8601022	SK-S 5.0	8601023





## DB 3P-35/16 1/6

W/Aluminum or copper cable input

Metric	 $\text{mm}^2$		$\theta$		N.m
	10...35	×3	10		5
	2.5...16	×18	6.1		3

W/ Flexible bus bar input



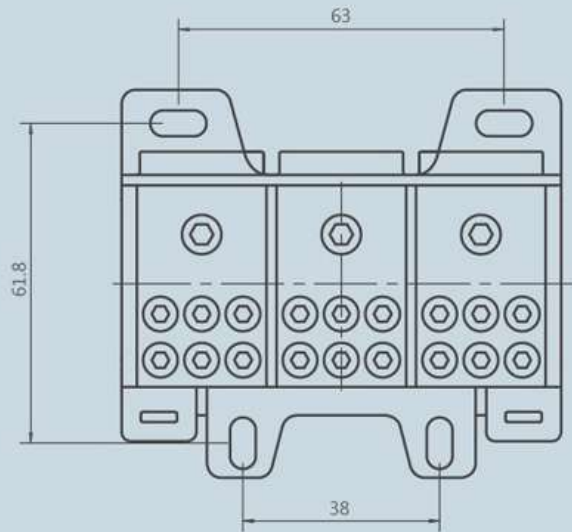

W/ Flexible bus bar input end	
9×3×0.8 - 9×6×0.8	

Metric	 $\text{mm}^2$		$\theta$		N.m
	10...35	×3			5
	2.5...16	×18	6.1		3







## DB 3P-70/16 1/6

W/Aluminum or copper cable input

Metric	 $\text{mm}^2$		$\theta$		N.m
	16...70	×3	12		5
	2.5...16	×18	6.1		3

W/ Flexible bus bar input

W/ Flexible bus bar input end	
13×3×0.5 - 13×6×0.5	

Metric	 $\text{mm}^2$		$\theta$		N.m
	16...70	×3			5
	2.5...16	×18	6.1		3

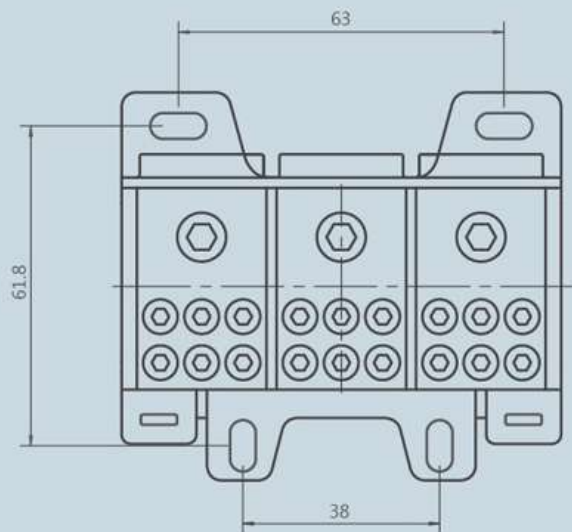



DB 16/6 3/4

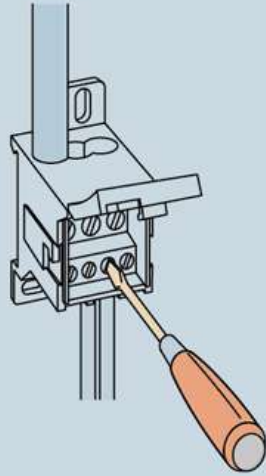
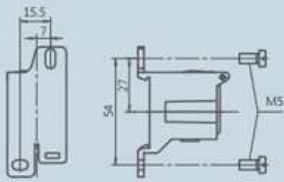

DB 35-16/6 1-1/8  
DB 70-16/6 1-1/8

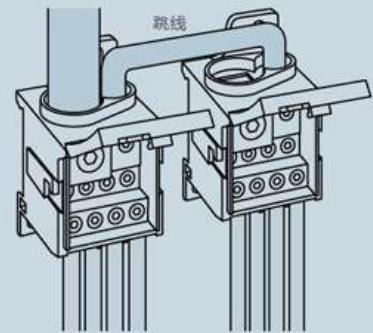
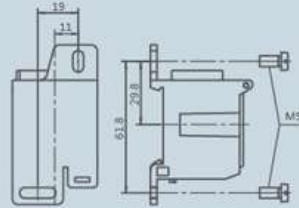

DB 120/35-16-10 1/2-5-4  
DB 185/35-16-10 1/2-5-4

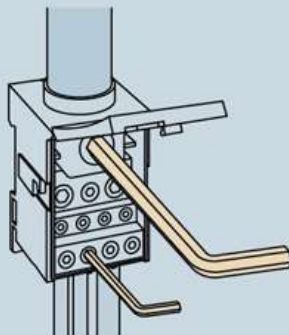
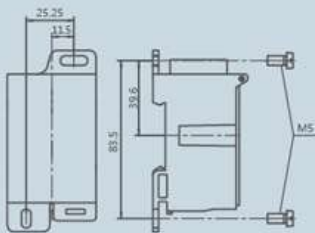

DB 3P-35/16 1/6  
DB 3P-70/16 1/6

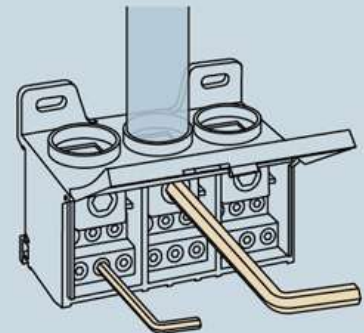
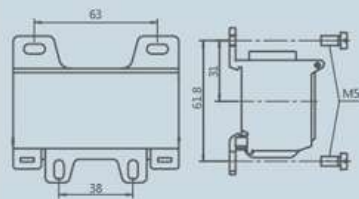

# Distribution Terminal Box 4 Pole

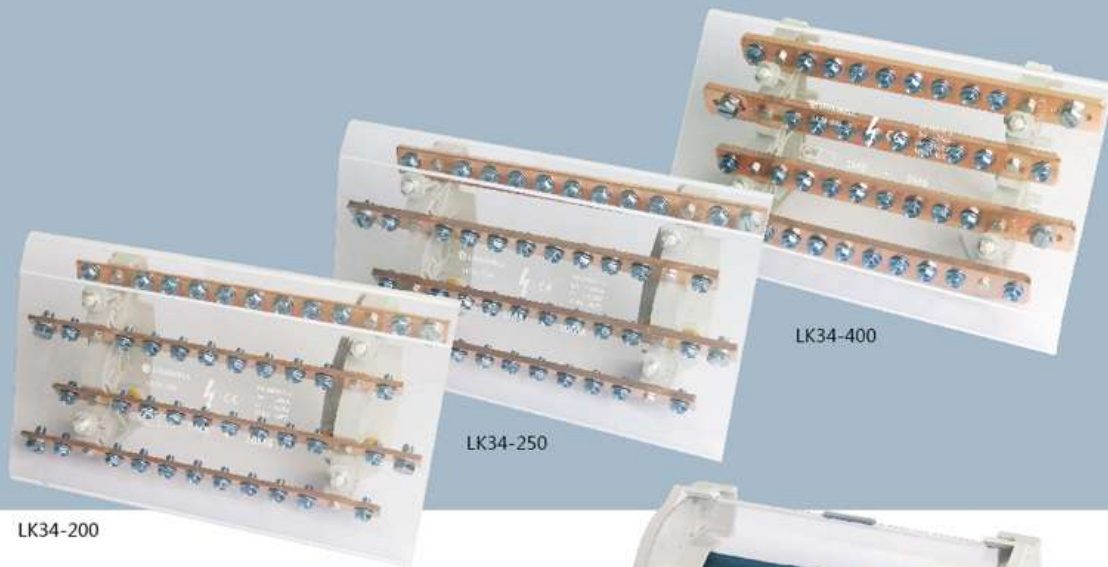

- Compact space and highest capacity
- Safe and easy electric connection
- Protection: Transparent cover
- Snap-on DIN rail or mount to panel with screws
- Halogen-free
- Confirm to ROHS
- Icc up to 35KA

LTK34-160

Terminal Connection

## Material

PA, Polyamide 66.UL94V-0 grade, inflaming ratarding. good resist dissolve, good bounce impact force. Working Temperature: -30°C~110°C;

PC, Polycarbonate, good glossiness, inflaming retarding, good bounce impact force. and thermal stability is great. Working Temperature: -60°C~135°C;

Brass ( 160A ), Copper ( 200A、 250A、 400A );

Voltage: 250V/380V;

Color: clear/grey color.

Item no.	Rated Current(A)	Rated Voltage(V)	Phase	In/Out	Outline Dimensions(mm)
LK34-160	160	660	4	2x62+2x50+7x40+1x120	182x138x74
LK34-200	200	660	4	10M6+1M8	280x170x77
LK34-250	250	660	4	10M6+1M8	280x170x77
LK34-400	400	660	4	10M6+1M8	280x150x116



### KE60 Universal Terminal for Al/Cu Conductors

#### Technical Specification

Conductor Cross-section(mm<sup>2</sup>): 1.5-16 mm<sup>2</sup>

Housing: Polyamide

Mounting: DIN rail

Screw: Hexagon, 4mm

Operating Temperature (°C): Max 80°C

Standard: EN61238-1, EN60947-7-2

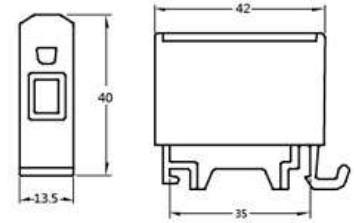

Model no.	Code	Color	Pole	Tighten torque(Nm)	Nominal Current(A)	Nominal Voltage(V)	Weight (g)
KE60.1	1914100	Grey	1 pole Al/Cu 1.5-16 mm <sup>2</sup>	1.5Nm(1.5 mm <sup>2</sup> )	85A	690V	15
KE60.2	1914101	Blue		3.5Nm(2.5-6 mm <sup>2</sup> )			
KE60.3	1914102	Yellow/Green		7Nm(10-16 mm <sup>2</sup> )			



### KE65 Universal Terminal Al/Cu Conductors

#### Technical Specification:

Conductor Cross-section(mm<sup>2</sup>): 2.5-35mm<sup>2</sup>

Housing: Polyamide PA66, UL94-V0

Mounting: 35mm din rail

Screw: Hexagon, 4mm, 4No.s

Operating Temperature(°C) max 80°C

Standard: EN61238-1, EN60947-7-2

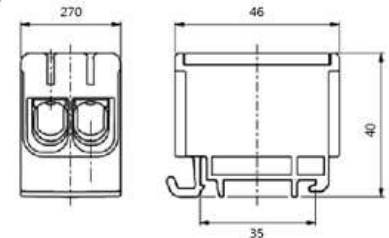

Model no.	Code	Color	Pole	Tighten torque(Nm)	Nominal Current(A)	Nominal Voltage(V)	Weight (g)
KE65.1	1914206	Grey	2pole Al/Cu2.5-35mm <sup>2</sup>	3Nm(2.5-16mm <sup>2</sup> )	CU 135A AL 120A	1000V	44
KE65.2	1914207	Blue		6Nm(25-35mm <sup>2</sup> )			
KE65.3	1914208	Yellow/green					



### KE61.4 3pole Universal Terminal for Al/Cu Conductors

#### Technical Specification

Pole: 3 pole

Conductor Cross-section(mm<sup>2</sup>):

Cu 2.5-50 mm<sup>2</sup> Al 6-50 mm<sup>2</sup>

Conductor Size (AWG): 1/0-6

Housing: Polyamide

Mounting: DIN rail

Screw: Hexagon, 5mm

Operating Temperature (°C): Max 80°C

Standard: EN61238-1, EN60947-7-2

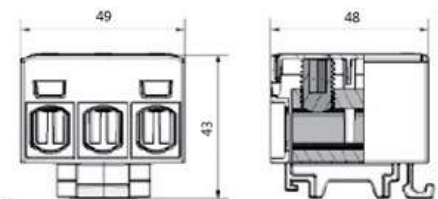

Model no.	Code	Color	Pole	Tighten torque(Nm)	Nominal Current(A)	Nominal Voltage(V)	Weight (g)
KE61.4	1914109	Grey	3 pole Al/Cu2.5-50 mm <sup>2</sup>	4Nm(2.5-4 mm <sup>2</sup> )	Cu 160A Al 145A	750V	35
KE61.5	1914110	Blue		12Nm(6-50 mm <sup>2</sup> )			
KE61.6	1914111	Yellow/Green					

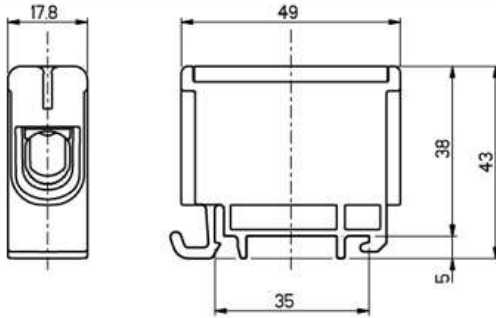

## KE61 Universal Terminal for Al/Cu Conductors

### Technical Specification

Conductor Cross-section(mm<sup>2</sup>):

Cu 2.5-50 mm<sup>2</sup> Al 6-50 mm<sup>2</sup>

Conductor Size (AWG): 1/0-6

Housing: Polyamide

Mounting: DIN rail

Screw: Hexagon, 5mm

Operating Temperature (°C): Max 80°C

Standard: EN61238-1, EN60947-7-2

Model no.	Code	Color	Pole	Tighten torque(Nm)	Nominal Current(A)	Nominal Voltage(V)	Weight ( g )
KE61.1	1914103	Grey	1 pole Al/Cu2.5-50 mm <sup>2</sup>	4Nm(2.5-4 mm <sup>2</sup> ) 12Nm(6-50 mm <sup>2</sup> )	Cu 160A Al 145A	750V	35
KE61.2	1914104	Blue					
KE61.3	1914105	Yellow/Green					

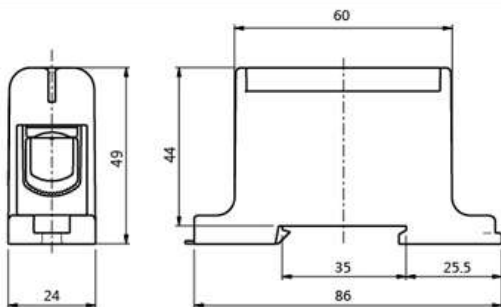

## KE62 Universal Terminal for Al/Cu Conductors

### Technical Specification

Conductor Cross-section(mm<sup>2</sup>): 16-95 mm<sup>2</sup>

Conductor Size (AWG): 4/0-4

Housing: Polyamide

Mounting: DIN rail

Screw: Hexagon, 5mm

Operating Temperature (°C): Max 80°C

Standard: EN 61238-1, EN 60947-7-1

Model no.	Code	Color	Pole	Tighten torque(Nm)	Nominal Current(A)	Nominal Voltage(V)	Weight ( g )
KE62.1	1914113	Grey	1 pole Al/Cu16-95 mm <sup>2</sup>	20Nm	Cu 245A Al 220A	750V	90
KE62.2	1914114	Blue					
KE62.3	1914115	Yellow/Green					

**KE63 Universal Terminal for Al/Cu Conductors**
**Technical Specification**

 Conductor Cross-section(mm<sup>2</sup>) : 35-150 mm<sup>2</sup>

Conductor Size (AWG): 300-2

Housing: Polyamide

Mounting: DIN rail

Screw: Hexagon, 8mm

Operating Temperature (°C): Max 80°C

Standard: SFS 2663

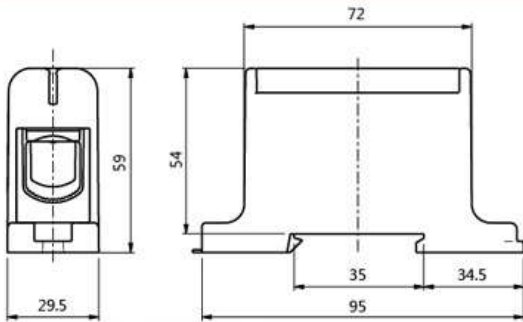

Model no.	Code	Color	Pole	Tighten torque(Nm)	Nominal Current(A)	Nominal Voltage(V)	Weight ( g )
KE63.1	1914118	Grey	1 pole	14Nm(35-95mm <sup>2</sup> ) 24Nm(120-150mm <sup>2</sup> )	Cu 320A Al 290A	750V	160
KE63.2	1914119	Blue	Al/Cu 35-150 mm <sup>2</sup>				
KE63.3	1914120	Yellow/Green					

**KE64 Universal Terminal for Al/Cu Conductors**
**Technical Specification**

 Conductor Cross-section(mm<sup>2</sup>) : 35-240 mm<sup>2</sup>

Conductor Size (AWG): 500-3/0

Housing: Polyamide

Mounting: Screw

Screw: Hexagon, 8mm

Operating Temperature (°C): Max 80°C

Standard: EN 61238-1, EN 60947-7-1

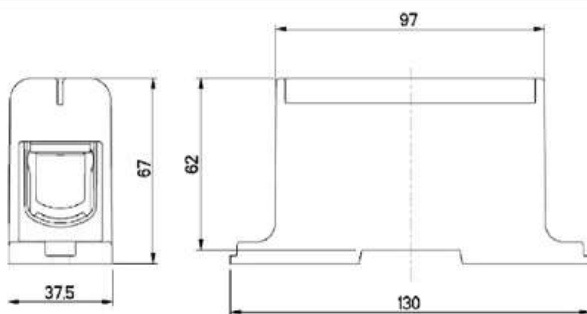

Model no.	Code	Color	Pole	Tighten torque(Nm)	Nominal Current(A)	Nominal Voltage(V)	Weight ( g )
KE64.1	1914130	Grey	1 pole Al/Cu 35-240 mm <sup>2</sup>	12Nm(35-70mm <sup>2</sup> ) 40Nm(95-240mm <sup>2</sup> )	Cu 425A Al 380A	750V	305
KE64.2	1914131	Blue					
KE64.3	1914132	Yellow/Green					

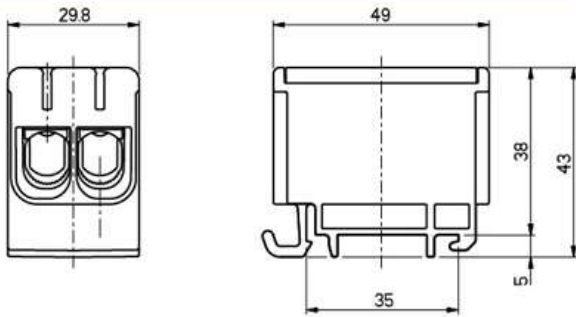

## KE66 Universal Terminal for Al/Cu Conductors

### Technical Specification

Conductor Cross-section(mm<sup>2</sup>) :

Cu 2.5-50 mm<sup>2</sup> Al 6-50 mm<sup>2</sup>

Conductor Size (AWG): 1/0-6

Housing: Polyamide

Mounting: DIN rail

Number of termination points : 4

Screw: Hexagon, 5mm

Operating Temperature (°C): Max 80°C

Standard: EN 61238-1, EN 60947-7-1

Model no.	Code	Color	Pole	Tighten torque(Nm)	Nominal Current(A)	Nominal Voltage(V)	Weight ( g )
KE66.1	1914106	Grey	2 pole Al/Cu2.5-50 mm <sup>2</sup>	4Nm(2.5-4 mm <sup>2</sup> ) 12Nm(6-50 mm <sup>2</sup> )	Cu 160A Al 145A	750V	60
KE66.2	1914107	Blue					
KE66.3	1914108	Yellow/Green					

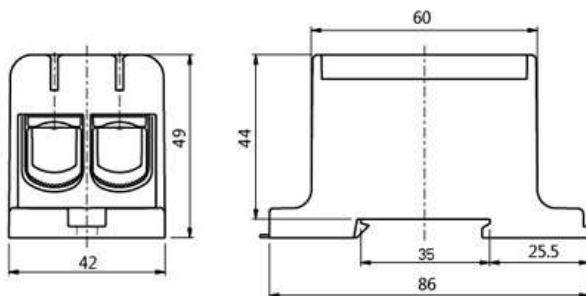

## KE67 Universal Terminal for Al/Cu Conductors

### Technical Specification

Conductor Cross-section(mm<sup>2</sup>) : 16-95 mm<sup>2</sup>

Conductor Size (AWG): 4/0-4

Housing: Polyamide

Mounting: DIN rail

Number of termination points : 4

Screw: Hexagon, 8mm

Operating Temperature (°C): Max 80°C

Standard: EN 61238-1, EN 60947-7-1

Model no.	Code	Color	Pole	Tighten torque(Nm)	Nominal Current(A)	Nominal Voltage(V)	Weight ( g )
KE67.1	1914125	Grey	2 pole Al/Cu16-95 mm <sup>2</sup>	20 Nm	Cu 245A Al 220A	750V	165
KE67.2	1914126	Blue					
KE67.3	1914127	Yellow/Green					

**KE68 Universal Terminal for Al/Cu Conductors**
**Technical Specification**

 Conductor Cross-section(mm<sup>2</sup>) : 35-150 mm<sup>2</sup>

Conductor Size (AWG): 300-2

Housing: Polyamide

Mounting: DIN rail

Number of termination points : 4

Screw: Hexagon, 8mm

Operating Temperature (°C): Max 80°C

Standard: EN 61238-1, EN 60947-7-1

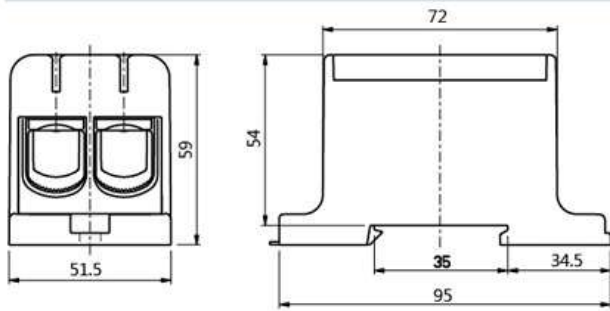

Model no.	Code	Color	Pole	Tighten torque(Nm)	Nominal Current(A)	Nominal Voltage(V)	Weight ( g )
KE68.1	1914124	Grey	2 pole Al/Cu35-150 mm <sup>2</sup>	20 Nm (35-95mm <sup>2</sup> )	Cu 320A Al 290A	750V	290
KE68.2	1914125	Blue		30 Nm (120-150mm <sup>2</sup> )			
KE68.3	1914126	Yellow/Green					

**KE69 Universal Terminal for Al/Cu Conductors**
**Technical Specification**

 Conductor Cross-section(mm<sup>2</sup>) : 35-240 mm<sup>2</sup>

Conductor Size (AWG): 500-3/0

Housing: Polyamide

Mounting: Screw

Number of termination points : 4

Screw: Hexagon, 8mm

Operating Temperature (°C): Max 80°C

Standard: EN 61238-1, EN 60947-7-1

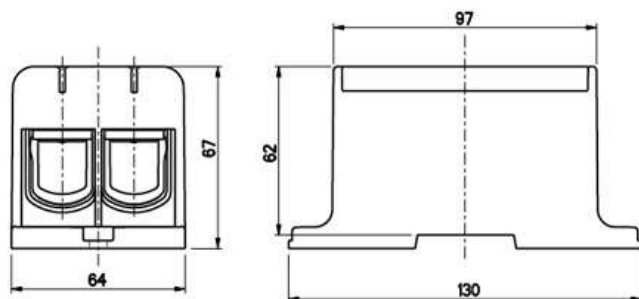

Model no.	Code	Color	Pole	Tighten torque(Nm)	Nominal Current(A)	Nominal Voltage(V)	Weight ( g )
KE69.1	1914133	Grey	2 pole Al/Cu 35-240 mm <sup>2</sup>	12 Nm (35-70mm <sup>2</sup> )	Cu 425A Al 380A	750V	550
KE69.2	1914134	Blue		45 Nm (95-240mm <sup>2</sup> )			
KE69.3	1914135	Yellow/Green					

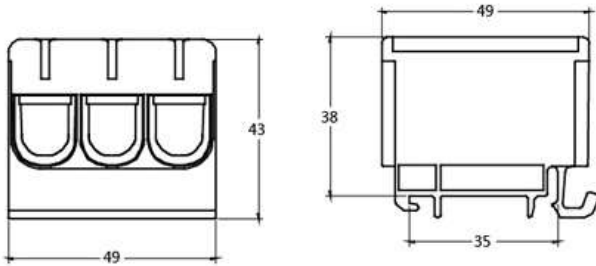

## KE71 Universal Terminal for Al/Cu Conductors

### Technical Specification

Conductor Cross-section(mm<sup>2</sup>) :

Cu 2.5-50 mm<sup>2</sup> Al 6-50 mm<sup>2</sup>

Conductor Size (AWG): 1/0-6

Housing: Polyamide

Mounting: DIN rail

Number of termination points : 4

Screw: Hexagon, 5mm

Operating Temperature (°C): Max 80°C

Standard: EN 61238-1, EN 60947-7-1

Model no.	Code	Color	Pole	Tighten torque(Nm)	Nominal Current(A)	Nominal Voltage(V)	Weight ( g )
KE71.1		Grey	3 pole Al/Cu 2.5-50 mm <sup>2</sup>	4Nm(2.5-4 mm <sup>2</sup> ) 12Nm(6-50 mm <sup>2</sup> )	Cu 160A Al 145A	750V	60
KE71.2		Blue					
KE71.3		Yellow/Green					

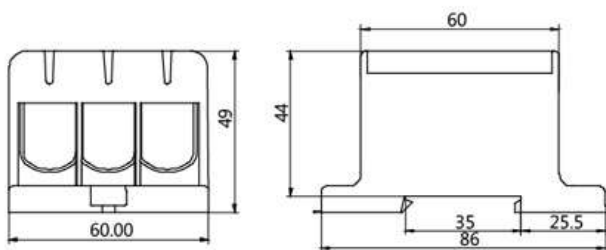

## KE72 Universal Terminal for Al/Cu Conductors

### Technical Specification

Conductor Cross-section(mm<sup>2</sup>) : 16-95 mm<sup>2</sup>

Conductor Size (AWG): 4/0-4

Housing: Polyamide

Mounting: DIN rail

Number of termination points : 4

Screw: Hexagon, 8mm

Operating Temperature (°C): Max 80°C

Standard: EN 61238-1, EN 60947-7-1

Model no.	Code	Color	Pole	Tighten torque(Nm)	Nominal Current(A)	Nominal Voltage(V)	Weight ( g )
KE72.1		Grey	3 pole Al/Cu 16-95 mm <sup>2</sup>	20 Nm	Cu 245A Al 220A	750V	165
KE72.2		Blue					
KE72.3		Yellow/Green					

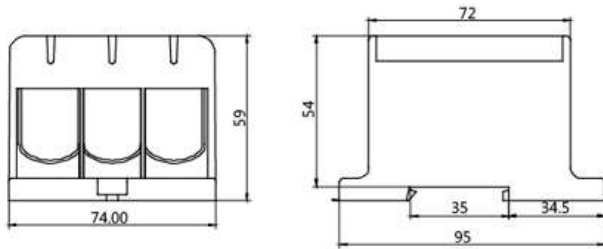
**KE73 Universal Terminal for Al/Cu Conductors**
**Technical Specification**

 Conductor Cross-section(mm<sup>2</sup>) : 35-150 mm<sup>2</sup>

Conductor Size (AWG): 300-2

Housing: Polyamide

Mounting: DIN rail

Number of termination points : 4

Screw: Hexagon, 8mm

Operating Temperature (°C): Max 80°C

Standard: EN 61238-1, EN 60947-7-1

Model no.	Code	Color	Pole	Tighten torque(Nm)	Nominal Current(A)	Nominal Voltage(V)	Weight ( g )
KE73.1		Grey	3 pole Al/Cu35-150 mm <sup>2</sup>	20 Nm (35-95mm <sup>2</sup> ) 30 Nm (120-150mm <sup>2</sup> )	Cu 320A Al 290A	750V	290
KE73.2		Blue					
KE73.3		Yellow/Green					

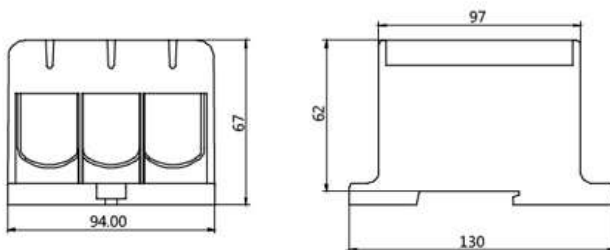
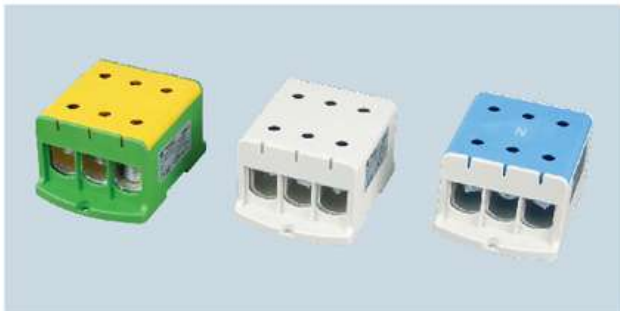
**KE74 Universal Terminal for Al/Cu Conductors**
**Technical Specification**

 Conductor Cross-section(mm<sup>2</sup>) : 35-240 mm<sup>2</sup>

Conductor Size (AWG): 500-3/0

Housing: Polyamide

Mounting: Screw

Number of termination points : 4

Screw: Hexagon, 8mm

Operating Temperature (°C): Max 80°C

Standard: EN 61238-1, EN 60947-7-1

Model no.	Code	Color	Pole	Tighten torque(Nm)	Nominal Current(A)	Nominal Voltage(V)	Weight ( g )
KE74.1		Grey	3 pole Al/Cu 35-240 mm <sup>2</sup>	12 Nm (35-70mm <sup>2</sup> ) 45 Nm (95-240mm <sup>2</sup> )	Cu 425A Al 380A	750V	550
KE74.2		Blue					
KE74.3		Yellow/Green					

# 1000V terminals

For Al/Cu conductors from 2.5 mm<sup>2</sup> to 150 mm<sup>2</sup>



## Features for 1000V terminals:

- Suitable for 1000 VAC and VDC
- Compact size
  - Can be installed next to each other without partition plates
- Suitable for both aluminium and copper conductors
- Short circuit tested class A terminals
- Higher temperature range (90 °C)

## Technical features

- Housing: fiberglass reinforced polyamide
  - Better mechanical strength vs. polyamide
  - Better insulating capacity
  - 90 °C temperature range achieved for the material
- Colours:
  - Red and black versions for DC applications
  - Grey and blue for AC applications (KE6x.3 to be used as a grounding terminal)

Standards	
For copper conductors:	EN 60947-7-1:2009
For aluminium conductors:	EN 61238-1:2003
Connector class	A
Technical information	
Cross-section range:	Al 6 - 150 mm <sup>2</sup> Cu 2.5 - 150 mm <sup>2</sup>
Nominal current range:	145 - 320 A
Operating temperature:	max. 90°C
Pollution degree	3
Material	
Housing:	Fiberglass reinforced polyamide
Body and screws:	Tin-coated aluminium
Mechanical features	
Screw heads:	Hexagonal
Mounting:	Screws or DIN rail

Terminal Connection



**1000V, one-pole terminal blocks**

Product code	Conductor cross-section (mm <sup>2</sup> )	Colour	Nominal current (A)	Nominal insulation voltage (V)	Screw head hexagon (mm)	Tightening torque (Nm)	Mounting	Weight (kg)	Package size (pcs)
LK161	Cu 2,5-50 mm <sup>2</sup> Al 6-50 mm <sup>2</sup>	Grey	Cu 160 A, Al 145 A	1000 V	5 mm	4 Nm (2.5-4mm <sup>2</sup> ), 12 Nm (6-50mm <sup>2</sup> )	DIN rail	0.045	30
LK161.2	Cu 2,5-50 mm <sup>2</sup> Al 6-50 mm <sup>2</sup>	Blue	Cu 160 A, Al 145 A	1000 V	5 mm	4 Nm (2.5-4mm <sup>2</sup> ), 12 Nm (6-50mm <sup>2</sup> )	DIN rail	0.045	30
LK161.4	Cu 2,5-50 mm <sup>2</sup> Al 6-50 mm <sup>2</sup>	Red	Cu 160 A, Al 145 A	1000 V	5 mm	4 Nm (2.5-4mm <sup>2</sup> ), 12 Nm (6-50mm <sup>2</sup> )	DIN rail	0.045	30
LK161.6	Cu 2,5-50 mm <sup>2</sup> Al 6-50 mm <sup>2</sup>	Black	Cu 160 A, Al 145 A	1000 V	5 mm	4 Nm (2.5-4mm <sup>2</sup> ), 12 Nm (6-50mm <sup>2</sup> )	DIN rail	0.045	30
LK162	Al/Cu 16-95 mm <sup>2</sup>	Grey	Cu 245 A, Al 220 A	1000 V	5 mm	20 Nm	DIN rail/screw	0.091	30
LK162.2	Al/Cu 16-95 mm <sup>2</sup>	Blue	Cu 245 A, Al 220 A	1000 V	5 mm	20 Nm	DIN rail/screw	0.091	30
LK162.4	Al/Cu 16-95 mm <sup>2</sup>	Red	Cu 245 A, Al 220 A	1000 V	5 mm	20 Nm	DIN rail/screw	0.091	30
LK162.6	Al/Cu 16-95 mm <sup>2</sup>	Black	Cu 245 A, Al 220 A	1000 V	5 mm	20 Nm	DIN rail/screw	0.091	30
LK163	Al/Cu 35-150 mm <sup>2</sup>	Grey	Cu 320 A, Al 290 A	1000 V	8 mm	20 Nm (35-95mm <sup>2</sup> ), 30 Nm (120-150mm <sup>2</sup> )	DIN rail/screw	0.143	30
LK163.2	Al/Cu 35-150 mm <sup>2</sup>	Blue	Cu 320 A, Al 290 A	1000 V	8 mm	20 Nm (35-95mm <sup>2</sup> ), 30 Nm (120-150mm <sup>2</sup> )	DIN rail/screw	0.143	30
LK163.4	Al/Cu 35-150 mm <sup>2</sup>	Red	Cu 320 A, Al 290 A	1000 V	8 mm	20 Nm (35-95mm <sup>2</sup> ), 30 Nm (120-150mm <sup>2</sup> )	DIN rail/screw	0.143	30
LK163.6	Al/Cu 35-150 mm <sup>2</sup>	Black	Cu 320 A, Al 290 A	1000 V	8 mm	20 Nm (35-95mm <sup>2</sup> ), 30 Nm (120-150mm <sup>2</sup> )	DIN rail/screw	0.143	30

The nominal currents in the table are for maximum cross-sections.

**UL recognitions**

Product code	Wire type	AWG* 1 wire/terminal	AWG* 2 Cu-wires/ terminal	AWG* 3 Cu-wires/ terminal	Max insulation voltage	Max current	Tightening torque	Allen-hex socket head terminal screw	Dimensions (W x H x D)
LK161	Cu Al	1/0 - 6 1/0 - 6	6	8	1000 V 1000 V	150 A 120 A	90 lb-in (10 Nm)	5 mm	3.25 x 1.89 x 0.76 In (82.5 x 48 x 19.2 mm)
LK162	Cu Al	4/0 - 4 4/0 - 4	2 - 6	6	1000 V 1000 V	230 A 180 A	126 lb-in (14 Nm)	5 mm	3.74 x 2.16 x 0.98 In (95 x 55 x 25 mm)
LK163	Cu Al	300 - 2 300 - 2	1/0 - 2	2	1000 V 1000 V	285 A 230 A	216 lb-in (24 Nm)	8 mm	4.15 x 2.58 x 1.20 In (105.5 x 65.5 x 30.4 mm)

Standard UL 1059

\* AWG = American Wire Gauge

All terminal blocks are delivered with oxide-inhibiting compound applied.



LK161



LK161.2



LK162.6



LK163.4



## Dimensional drawings

### LK 161

Dimensions in mm

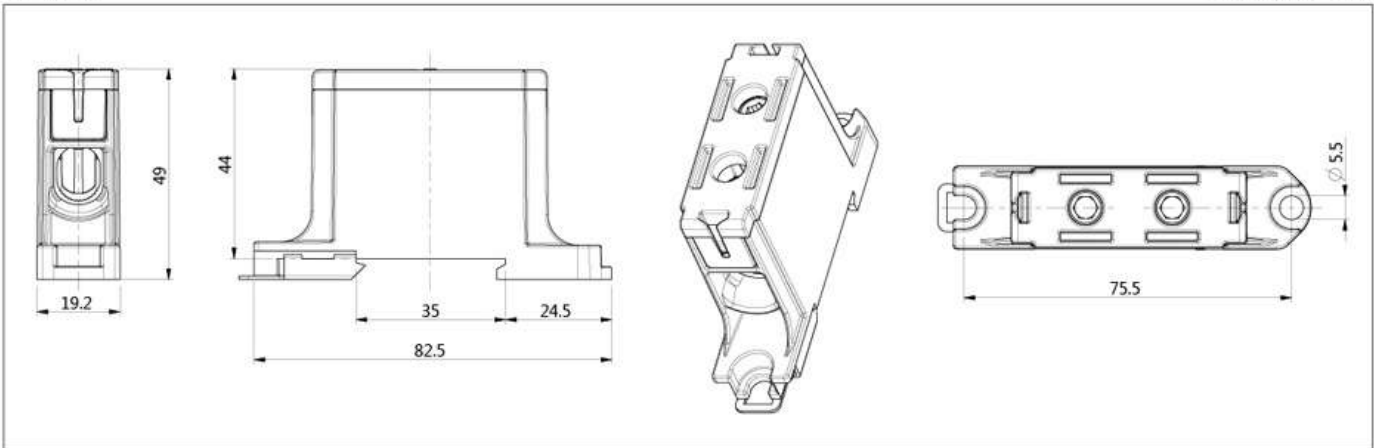

### LK 162

Dimensions in mm

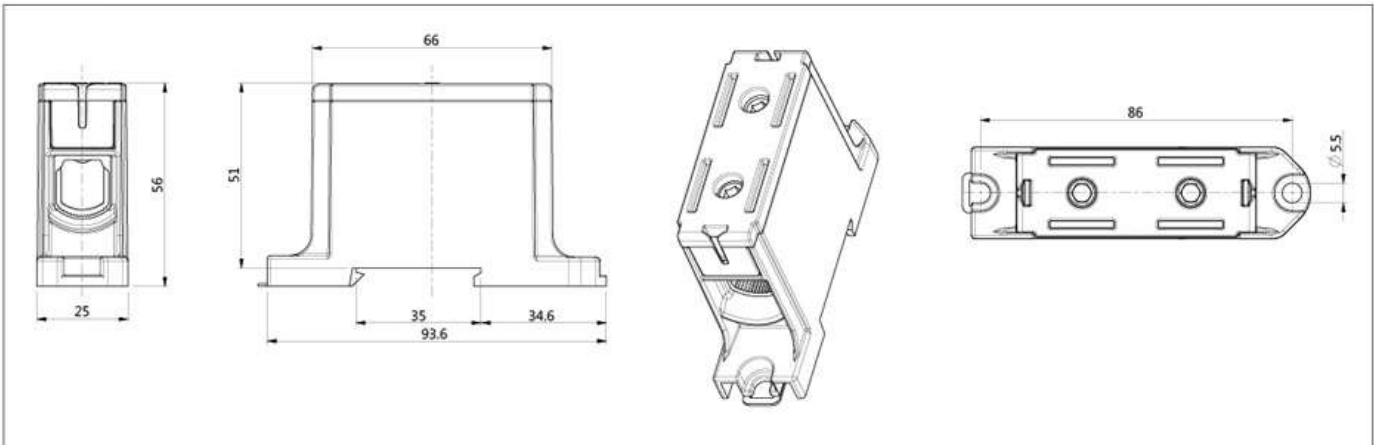

### LK 163

Dimensions in mm

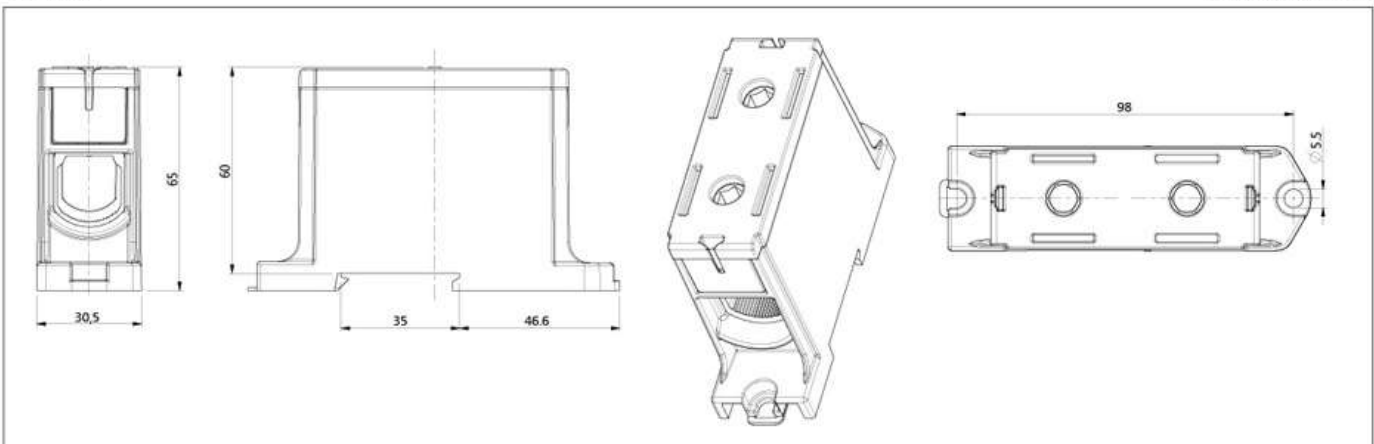

 CE  RoHS







**LUK 2.5B**

 solid cross section: 0.2-4mm<sup>2</sup>  
 stranded cross section: 0.2-2.5mm<sup>2</sup> IEC 60947-7-1  
 size: T6.2×H40.6×W42.6 Zack Strip(ZB6)  
 rated current: 32A rated voltage: 800V

 CE  RoHS

**LUK 3N**

 solid cross section: 0.2-4mm<sup>2</sup>  
 stranded cross section: 0.2-2.5mm<sup>2</sup> IEC 60947-7-1  
 size: T5.2×H46×W42.7 Zack Strip(ZB5)  
 rated current: 32A rated voltage: 800V

(1)end cover : T1.5mm	grey		D-LUK 2.5	D-LUK 4/10
(2)fixed bridge : 2 poles			FBI 10-6	FBI 10-5
(3)insertion bridge poles: 2 poles			EB 2-6	EB 2-5
			EB 3-6	EB 3-5
			EB 10-6	EB 10-5
(4)switching jumper			LUSBR 2-7	
(5)separating plate				TS-K
(6)partition plate : T1.5mm			ATP-LUK	
(7)end clamp			E/LUK	E/LUK

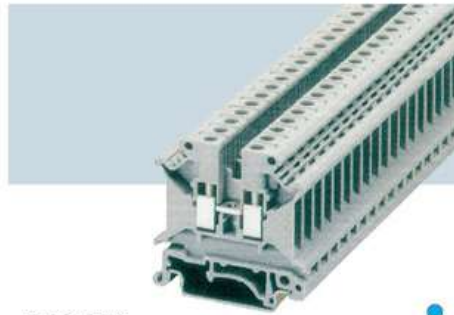



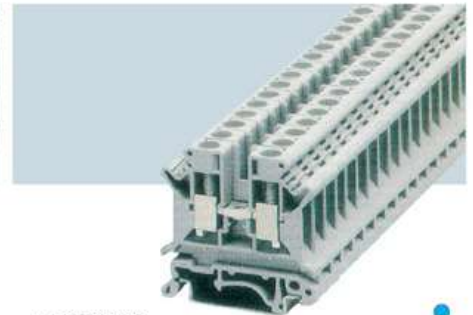



 CE  RoHS

**LUK 5N**

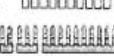
 solid cross section: 0.2-6mm<sup>2</sup>  
 stranded cross section: 0.2-4mm<sup>2</sup> IEC 60947-7-1  
 size: T6.2×H46.2×W42.6 Zack Strip(ZB6)  
 rated current: 41A rated voltage: 800V

 CE  RoHS

**LUK 6N**

 solid cross section: 0.2-10mm<sup>2</sup>  
 stranded cross section: 0.2-6mm<sup>2</sup> IEC 60947-7-1  
 size: T8.2×H46×W42.7 Zack Strip(ZB8)  
 rated current: 57A rated voltage: 800V

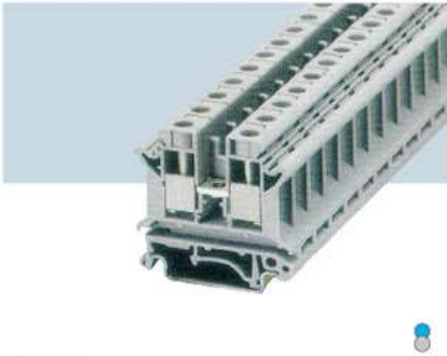
(1)end cover : T1.5mm	grey		D-LUK 4/10	D-LUK 4/10
(2)fixed bridge : 2 poles			FBI 10-6	FBI 10-8
(3)insertion bridge poles: 2 poles			EB 2-6	EB 2-8
			EB 3-6	EB 3-8
			EB 10-6	EB 10-8
(4)switching jumper			LUSBR 2-7	LUR 2-8/13
(5)separating plate			TS-K	TS-K
(6)partition plate : T1.5mm			ATP-LUK	ATP-LUK
(7)end clamp			E/LUK	E/LUK



CE RoHS

## LUK 10N

IEC 60947-7-1

solid cross section: 0.5-16mm<sup>2</sup> stranded cross section: 0.5-10mm<sup>2</sup>  
size: T10.2×H42.8×W42.5  
rated current: 76A rated voltage: 800V Zack Strip(ZB10)

D-LUK 4/10

FBI 10-10

EB 2-10  
EB 3-10  
EB 10-10

TS-K

ATP-LUK

E/LUK



CE RoHS

## LUK 16N

IEC 60947-7-1

solid cross section: 2.5-25mm<sup>2</sup> stranded cross section: 4-16mm<sup>2</sup>  
size: T12.2×H52.2×W42.5  
rated current: 100A rated voltage: 800V Zack Strip(ZB10)

D-LUK 16

FBI 10-12

EB 2-12  
EB 3-12  
EB 10-12

TS-K

ATP-LUK

E/LUK

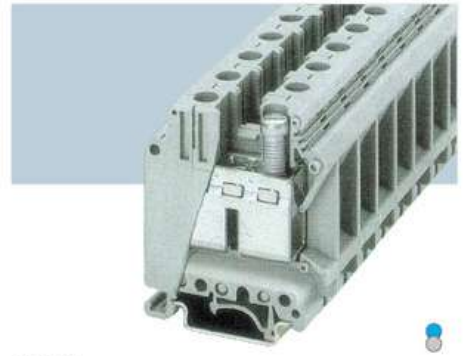

CE RoHS

## LUK 35N

IEC 60947-7-1

solid cross section: 10-35mm<sup>2</sup> stranded cross section: 10-35mm<sup>2</sup>  
size: T15.2×H52.7×W50.7  
rated current: 125A rated voltage: 800V Zack Strip(ZB10)

FBI 2-15  
FBI 3-15

EB 2-15  
EB 3-15  
EB 10-15

TS-K

E/LUK

## Fuse Terminal Block

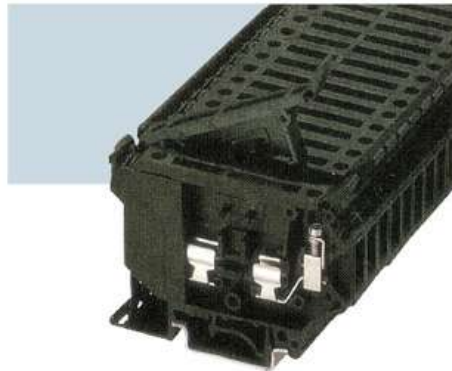

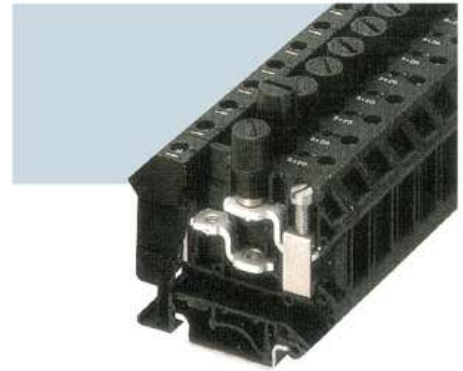

### LUK 5-HESI

solid cross section: 0.2-4mm<sup>2</sup> stranded cross section: 0.2-4mm<sup>2</sup>  
size: T8.2×H46.2×W72.6  
rated current: 6.3A rated voltage: 800V Zack Strip(ZB8)



### LUK 10-DREHSI

solid cross section: 0.5-16mm<sup>2</sup> stranded cross section: 0.5-16mm<sup>2</sup>  
size: T12.3×H55×W61.5  
rated current: 10A rated voltage: 800V Zack Strip(ZB8)

For fuse 5x20, indicators are optional		LUK10-DREHSI 5×20
Consumed current with indicator 15-24 V AC/DC 3.5-7.5 mA		LUK10-DREHSILED 24 5×20
Consumed current with indicator 110-250 V AC/DC 1.5-3.5 mA AC, 0.2-0.8 mA DC		LUK10-DREHSILED 250 5×20
Consumed current with indicator 15-24 V AC/DC 3.5-7.5 mA	LUK5-HESILED 24	
Consumed current with indicator 110-250 V AC/DC 1.5-3.5 mA AC/0.2-0.8 mA DC	LUK5-HESILED 250	
(1) fixed bridge 		FBI 10-12
(2)insertion bridge poles:  2 poles 3 poles 10 poles	EB 2-8 EB 3-8 EB 10-8	EB 2-12 EB 3-12 EB 10-12

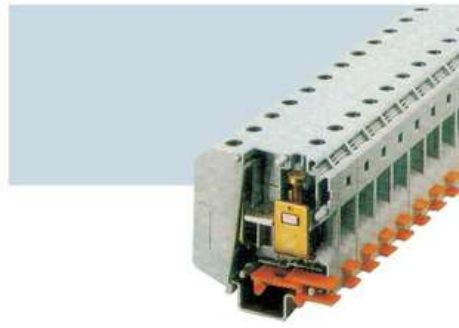

**LUKH 50**

solid cross section: 16-50mm<sup>2</sup> stranded cross section: 25-50mm<sup>2</sup>  
 size: T20×H76.2×W71.2 IEC 60947-7-1  
 rated current: 150A rated voltage: 1000V Zack Strip(ZB10)

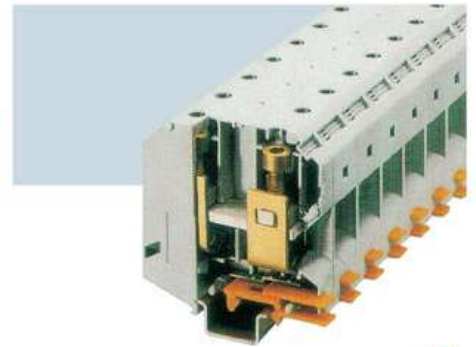

**LUKH 95**

solid cross section: 25-95mm<sup>2</sup> stranded cross section: 35-95mm<sup>2</sup>  
 size: T25×H91×W83.9 IEC 60947-7-1  
 rated current: 232A rated voltage: 1000V Zack Strip(ZB10)

Insertion bridge:	2 poles 3 poles			EB 2-25 EB 3-25
Din Rail type			E/AL-NS 35	E/AL-NS 35

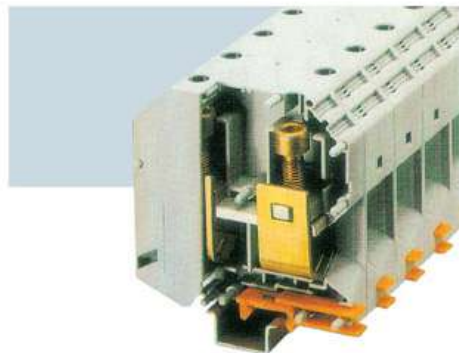

**LUKH 150**

solid cross section: 35-150mm<sup>2</sup> stranded cross section: 50-150mm<sup>2</sup>  
 size: T31.5×H111.2×W100.1 IEC 60947-7-1  
 rated current: 309A rated voltage: 1000V Zack Strip(ZB10)



**LUKH 240**

solid cross section: 70-240mm<sup>2</sup> stranded cross section: 70-240mm<sup>2</sup>  
 size: T36×H122.5×W101.5 IEC 60947-7-1  
 rated voltage: 1000V Zack Strip(ZB10)

Insertion bridge:	2 poles 3 poles		EB 2-31 EB 3-31	
Din Rail type			E/AL-NS 35	E/AL-NS 35

(1) end cover	grey		D-LUKK 3/5
(2) space compensation plate	grey		DG-LUKK 3/5
(3) space compensation plate			DP-LUKK 3/5
(4)insertion bridge poles:	2 poles 3 poles 10 poles		EB 2-6 EB 3-6 EB 10-6
(5) with insulation pads bridge pieces			FBI 10-6

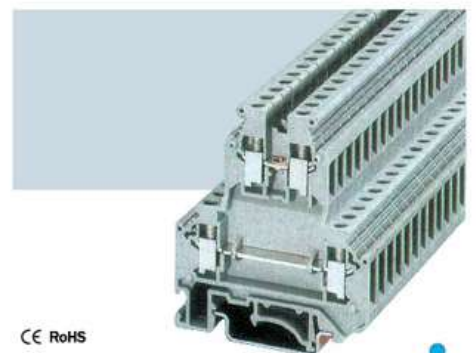

CE RoHS

**LUKK 5**

solid cross section: 0.2-4mm<sup>2</sup> stranded cross section: 0.2-4mm<sup>2</sup>  
 size: T6.2×H61.2×W56.5 IEC 60947-7-1  
 rated current: 32A rated voltage: 500V Zack Strip(ZB6)



# LMTK Knife Terminal Block/LUK Universal Terminal Blocks

## LMTK Knife Disconnect Terminal Block



### LMTK-P/P

solid cross section: 0.2-4mm<sup>2</sup> stranded cross section: 0.2-2.5mm<sup>2</sup>  
 size: T5.2×H52×W46 IEC 60947-7-1  
 rated current: 16A rated voltage: 800V Zack Strip(ZB5)

### LUK 5-MTK-P/P<sup>With test socket screws</sup>

solid cross section: 0.2-4mm<sup>2</sup> stranded cross section: 0.2-4mm<sup>2</sup>  
 size: T6.2×H62×W51.6 IEC 60947-7-1  
 rated current: 16A rated voltage: 800V Zack Strip(ZB6)

Insertion Bridge: Insulated 2-poles Insulated 3-poles Divisible,back insulated 10-poles		EB 2-5 EB 3-5 EB 10-5	EB 2-6 EB 3-6 EB 10-6
(1)End cover	Grey	D-LUDK4	Closed housing, No need cover



### LUDK 4

solid cross section: 0.2-4mm<sup>2</sup> stranded cross section: 0.2-2.5mm<sup>2</sup>  
 size: T6.2×H45.5×W58.4 IEC 60947-7-1  
 rated current: 32A rated voltage: 690V Zack Strip(ZB6)

### LUDK 10

solid cross section: 0.5-16mm<sup>2</sup> stranded cross section: 0.5-10mm<sup>2</sup>  
 size: T10.2×H56.7×W64.9 IEC 60947-7-1  
 rated current: 57A rated voltage: 690V Zack Strip(ZB10)

End cover	Grey	D-JUDK 4	D-JUDK 10
(1)Fixed Bridge: For cross connection at terminal center,10 screws,screw head with insulate collar,10 poles,divisible		FBI 10-6	FBI 10-10
(2)Insertion Bridge: Insulated 2-poles Insulated 3-poles Divisible,back insulated 10-poles		EB 2-6 EB 3-6 EB 10-6	EB2-10 EB3-10 EB10-10
(3)End Clamp: mounting at the terminal end, W10mm, For DIN rail C or L to support double terminal rows		E-LUK	E-LUK

## LUK universal terminal blocks



Knife disconnect terminal: Universal mounting clamp For DIN rail type C or L Test socket available at both sides		
End cover	Grey	D-LURTK/S
(1)Fixed Bridge , Divisible to disconnect the neighbouring terminal connections on both sides 10 poles, divisible, with 10 screws		FB10-LRTK/S
(2)Insertion Bridge: Insulated 2-poles Insulated 3-poles Divisible,back insulated 10-poles		EB 2-8 EB 3-8 EB 10-8
(3)switching jumper: On both sides of the disconnect point,switching inward, with 2 screws		LUSB2-LRTK/S

CE RoHS

### LURTK/S

solid cross section: 0.5-10mm<sup>2</sup> stranded cross section: 0.5-6mm<sup>2</sup>  
 size: T8.1×H50.9×W72.5 IEC 60947-7-1  
 rated current: 57A rated voltage: 400V Zack Strip(ZB8)

Terminal Connection

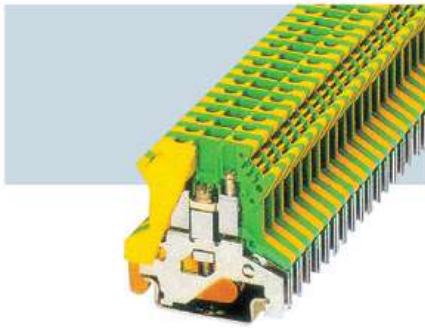
**LUSLKG 2.5**

solid cross section: 0.2-4mm<sup>2</sup>  
 stranded cross section: 0.2-2.5mm<sup>2</sup> IEC 60947-7-2  
 size: T6.2×H42×W42.9 Zack Strip(ZB6)

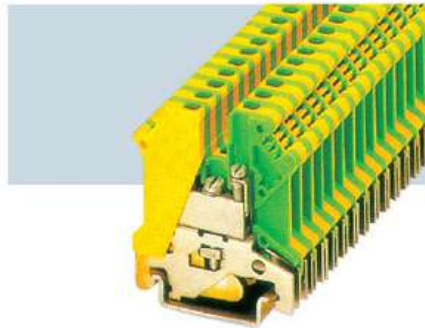
**LUSLKG3**

solid cross section: 0.2-4mm<sup>2</sup>  
 stranded cross section: 0.2-2.5mm<sup>2</sup> IEC 60947-7-2  
 size: T5.2×H46×W42.9 Zack Strip(ZB5)

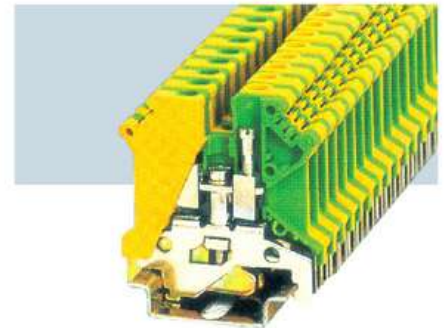
**LUSLKG 5**

solid cross section: 0.2-4mm<sup>2</sup>  
 stranded cross section: 0.2-4mm<sup>2</sup> IEC 60947-7-2  
 size: T6.2×H46×W43.1 Zack Strip(ZB6)

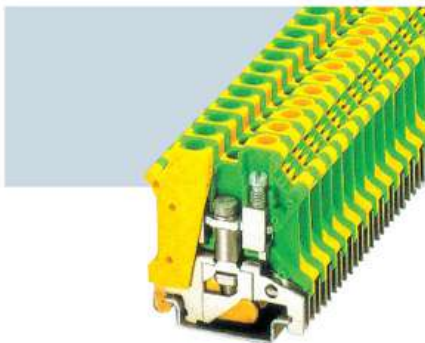
**LUSLKG 6**

solid cross section: 0.2-10mm<sup>2</sup>  
 stranded cross section: 0.2-6mm<sup>2</sup> IEC 60947-7-2  
 size: T8.2×H46×W42.6 Zack Strip(ZB8)

**LUSLKG 10**

solid cross section: 0.5-16mm<sup>2</sup>  
 stranded cross section: 0.5-10mm<sup>2</sup> IEC 60947-7-2  
 size: T10.2×H46×W42.4 Zack Strip(ZB10)

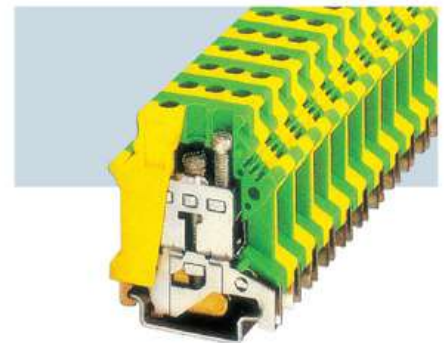
**LUSLKG 16**

solid cross section: 2.4-25mm<sup>2</sup>  
 stranded cross section: 4-16mm<sup>2</sup> IEC 60947-7-2  
 size: T12.2×H46×W43.1 Zack Strip(ZB10)

**LUSLKG 35**

solid cross section: 10-35mm<sup>2</sup>  
 stranded cross section: 10-35mm<sup>2</sup> IEC 60947-7-2  
 size: T15.2×H62×W50.3 Zack Strip(ZB10)

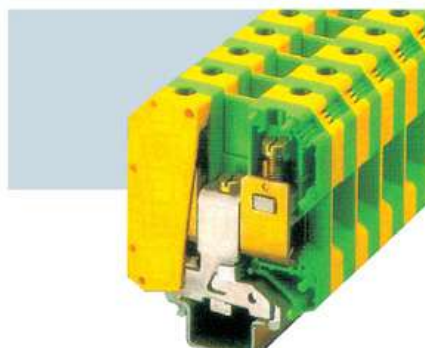
**LUSLKG 50**

solid cross section: 16-50mm<sup>2</sup>  
 stranded cross section: 25-50mm<sup>2</sup> IEC 60947-7-2  
 size: T20.5×H83.5×W71 Zack Strip(ZB10)



**LUKK5-PE**

solid cross section: 0.2-4mm<sup>2</sup>  
 stranded cross section: 0.2-4mm<sup>2</sup> IEC 60947-7-2  
 size: T6.2×H63×W56.8 Zack Strip(ZB6)

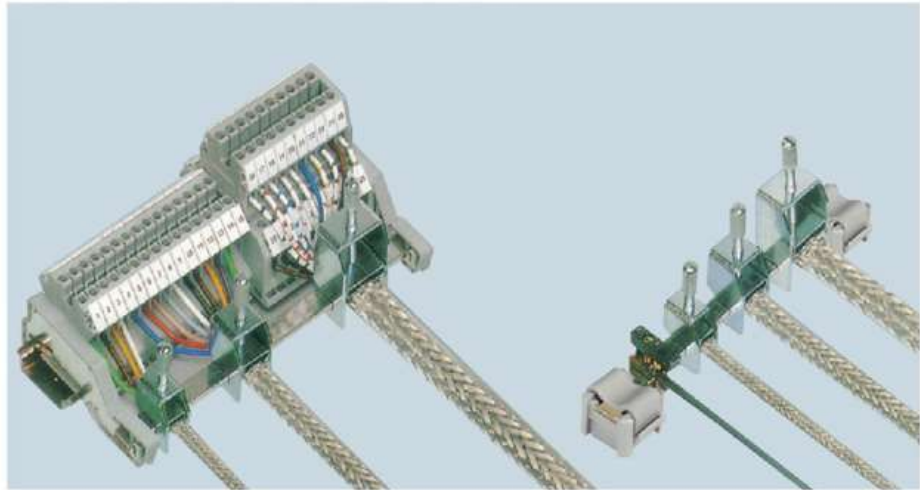

## LSK 8 LSK 14 LSK 20 LSK 35

Shielding terminal block can be easily used with the holder LAB-SK. It is convenient to install by connecting with busbar.



	Model	Cable Diameter	Packing
(1) Holder: installing with 10 x 3mm busbar	LSK 8	Φ8mm	10
	LSK 14	Φ14mm	10
	LSK 20	Φ20mm	10
	LSK 35	Φ35mm	10
	LAB-SK		10
(2) Copper busbar: 10 x 3mm, 1000mm, Tin plated	NLS-CU 3/10	$I_{max}$ : 140A	10
(3) Insulating holder:	AB/SS		10

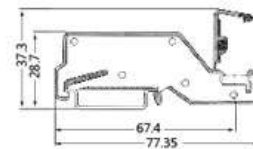

LSK8 LSK14 LSK20 LSK35

LAB-SK

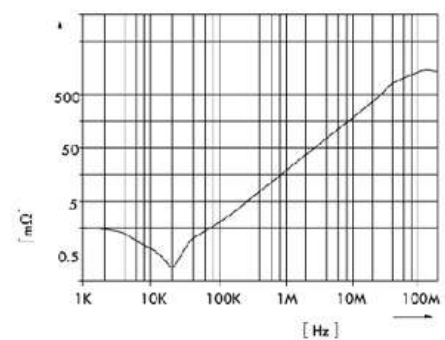
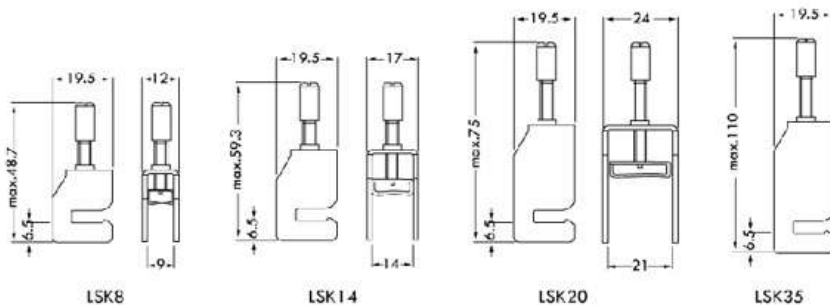

**AK/AKG**

Both AK and AKG interconnected end is designed for fixing the installed end. They are installed on the busbar 3x6mm and 6x6mm.

AK: Without insulation cap

AKG: with insulation cap at different colours.

There are also three different holders for different user, which including single, double, and triple layers.



Connection data	Solid wire [mm <sup>2</sup> ]	Multiple Wire [mm <sup>2</sup> ]	AWG	I [A]
J(AKG) 4	0.5-4	0.5-4	20-12	32*
J(AKG) 16	1.5-16	1.5-16	16-6	76*
J(AKG) 35	1.5-35	1.5-25	16-2	125*

\*Pay attention to the current loading capacity of busbar

**AKG 4 AKG 16 AKG 35**



AB2/SS



AB3/SS

	Model	Packing
N/PE interconnected end: 4mm <sup>2</sup>	⊗ AK 4	100
	⊗ AKG 4 BU	100
	⊗ AKG 4 GNYE	100
	⊗ AKG 4 BK	100
N/PE interconnected end: 16mm <sup>2</sup>	⊗ AK 16	100
	⊗ AKG 16 BU	100
	⊗ AKG 16 GNYE	100
	⊗ AKG 16 BK	100
N/PE interconnected end: 35mm <sup>2</sup>	⊗ AK 35	50
	⊗ AKG 35 BU	50
	⊗ AKG 35 GNYE	50
	⊗ AKG 35 BK	50
Copper Busbar: 3x10mm, tin plated, rated current 140A	NLS-CU 3/10	10
Single holder: using for busbar 3x10mm and 6x6mm	AB/SS	10
Double-layer holder: using for busbar 3x10mm and 6x6mm	AB 2/SS	10
	ABN 2/SS	10



JAKG (BK)



JAKG (GNYE)



JAKG (BU)

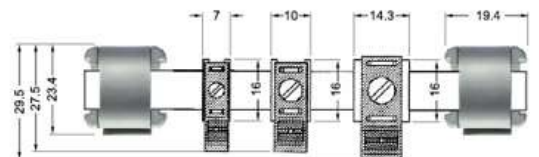
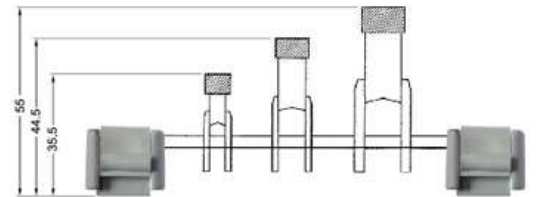
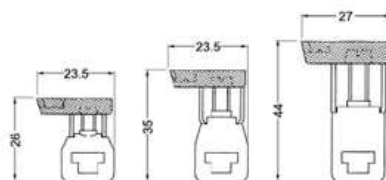

## Terminal strip marker

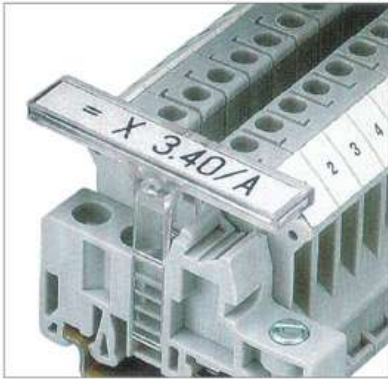

SCHT 3S



Adjustable height

### LKLM-A

Insert strip- Sheet, with locator holes and lines  
Used for terminal strip markers KLM1  
Lettering area size 24x4mm

Terminal strip marker : For strip marking  
Adjustable height,  
Mount on on DIN rail E/UK-NS 35 or E/NS/35N  
Used marker pen B-STIFT or DMS system  
Marking for insert strip ES/KLM2-GB  
Lettering area size 44x7mm

Terminal strip marker :  
Same above, without insert strip marker ES/KLM 2-GB

packing units 50

SCHT 5S



B1

B2

### B1/B2 (Grey)

Terminal strip marker : For strip marking  
Mounting on Din rail □ or □, with insert strip marker  
Used B-STIFT or CMS system to mark the strip  
Lettering field size 40x17mm

packing units 10

## End clamp

E/LMK 1 E/LUK E/AL-NS35



E/AL-NS 35

E/LUK



E/LMK 1



E/LUK



E/AL-NS 35

### E/LMK 1

End clamp: mount on □ DIN rail NS15, T 6mm  
mounting hole  $\Phi$ 3.2mm material : KRILEN

### E/LUK

End Clamp:mounting on Din rail □ or □, fit for KLM  
strip marker or 1 piece of label No....8, T 9.5mm  
Material : KRILEN

### E/AL-NS35

End clamp: enhanced design, made of aluminum, to support  
end 50- 240mm<sup>2</sup> of the terminal strips, push mounting on □  
Din rail  
Clamped by 2 screws and,fit for 2 piece of label No.... 10, T 9.5mm

LEW 35

LEW 15

E/LUK  
End clamp  
Mount on Din rail NS32 or NS35/7.5



E/LMK1  
Color: Grey  
End clamp: T6mm

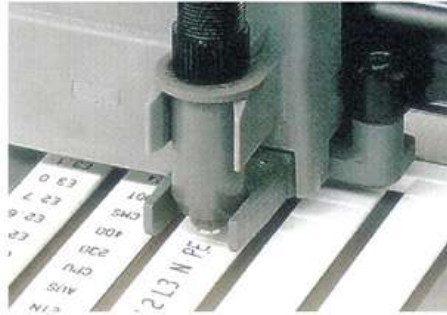
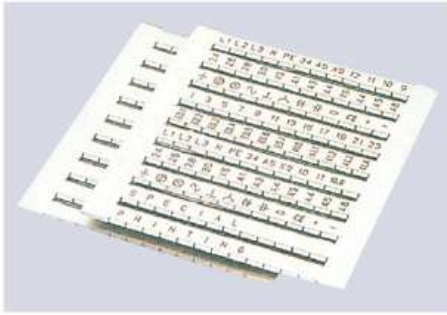

**ZB**

Model no. Blank	Model no.	Model no.
ZB4-BLANK	ZB5 1-10	ZB6 1-10
ZB5-BLANK	ZB5 11-20	ZB6 11-20
ZB6-BLANK	ZB5 21-30	ZB6 21-30
ZB8-BLANK	ZB5 31-40	ZB6 31-40
ZB10-BLANK	ZB5 41-50	ZB6 41-50
DEK5-BLANK	ZB5 51-60	ZB6 51-60
DEK6-BLANK	ZB5 61-70	ZB6 61-70
	ZB5 71-80	ZB6 71-80
	ZB5 81-90	ZB6 81-90
	ZB5 91-100	ZB6 91-100
	ZB8 1-10	ZB10 1-10
	ZB8 11-20	ZB10 11-20
	ZB8 21-30	ZB10 21-30
	ZB8 31-40	ZB10 31-40
	ZB8 41-50	ZB10 41-50
	ZB8 51-60	ZB10 51-60
	ZB8 61-70	ZB10 61-70
	ZB8 71-80	ZB10 71-80
	ZB8 81-90	ZB10 81-90
	ZB8 91-100	ZB10 91-100

**DEK**

Model no.	Model no.	Model no.
ZB4 1-10	DEK5 1-10	DEK6 1-10
ZB4 11-20	DEK5 11-20	DEK6 11-20
ZB4 21-30	DEK5 21-30	DEK6 21-30
ZB4 31-40	DEK5 31-40	DEK6 31-40
ZB4 41-50	DEK5 41-50	DEK6 41-50
ZB4 51-60	DEK5 51-60	DEK6 51-60
ZB4 61-70	DEK5 61-70	DEK6 61-70
ZB4 71-80	DEK5 71-80	DEK6 71-80
ZB4 81-90	DEK5 81-90	DEK6 81-90
ZB4 91-99	DEK5 91-100	DEK6 91-100

# Economy Type Terminal Connection

## LSAK(SAK)series



### LSAK 2.5EN

Approval	CE RoHS
Insulating Material	PA66
Inflammability Class	UL 94 V0
Connection Standard	IEC 60947-7-1



### LSAK 4EN

Approval	CE RoHS
Insulating Material	PA66
Inflammability Class	UL 94 V0
Connection Standard	IEC 60947-7-1

### LSAK 6EN

Approval	CE RoHS
Insulating Material	PA66
Inflammability Class	UL 94 V0
Connection Standard	IEC 60947-7-1

size	T6.1×H40.4×W40.9	T6.5×H45.3×W40.6	T7.9×H45×W39.9
rated current/voltage	24A/800V	32A/800V	41A/800V
stranded cross section	0.2mm <sup>2</sup> -2.5mm <sup>2</sup>	0.2mm <sup>2</sup> -4mm <sup>2</sup>	0.2mm <sup>2</sup> -6mm <sup>2</sup>
packing	50	50	50
connection type	screw connection	screw connection	screw connection
Din Rail type	TS 35/7.5, TS 35/15, TS 32	TS 35/7.5, TS 35/15, TS 32	TS 35/7.5, TS 35/15, TS 32

(1)end cover: T1.5mm 	AP 2.5	AP 4-10	AP 4-10
(2) Centre type jumper bar: 10 potential, 3,5,10 potential 	2.5 EN Q2poles, 3poles, 10poles	4 EN Q2poles, 3poles, 10poles	6 EN Q2poles, 3poles, 10poles
(3)end clamp 	LEW 35	LEW 35	LEW 35
(4)Continuous number of printing	DEK 5/6(1...10)	DEK 6(1...10)	DEK 6(1...10)



### LSAK 10EN

Approval	CE RoHS
Insulating Material	PA66
Inflammability Class	UL 94 V0
Connection Standard	IEC 60947-7-1



### LSAK 16EN

Approval	CE RoHS
Insulating Material	PA66
Inflammability Class	UL 94 V0
Connection Standard	IEC 60947-7-1

### LSAK 35EN

Approval	CE RoHS
Insulating Material	PA66
Inflammability Class	UL 94 V0
Connection Standard	IEC 60947-7-1

size	T10×H45.2×W40.5	T12×H51.2×W50.3	T18.2×H61.6×W58.5
rated current/voltage	57A/800V	76A/800V	125A/800V
stranded cross section	0.5mm <sup>2</sup> -10mm <sup>2</sup>	0.5mm <sup>2</sup> -16mm <sup>2</sup>	10mm <sup>2</sup> -35mm <sup>2</sup>
packing	50	50	50
connection type	screw connection	screw connection	screw connection
Din Rail type	TS 35/7.5, TS 35/15, TS 32	TS 35/7.5, TS 35/15, TS 32	TS 35/7.5, TS 35/15, TS 32

(1)end cover: T1.5mm 	AP 4-10	AP 16	AP 35
(2) Centre type jumper bar: 10 potential, 3,5,10 potential 	10 EN Q2poles, 3poles, 10poles	16 EN Q2poles, 3poles, 10poles	35 EN Q2poles, 3poles, 10poles
(3)end clamp 	LEW 35	LEW 35	LEW 35
(4)Continuous number of printing	DEK 6(1...10)	DEK 6(1...10)	DEK 6(1...10)

Terminal Connection

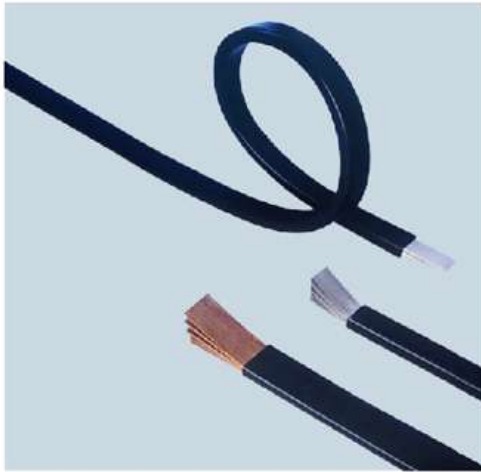

### Technical data of electrical conductor

- Copper strips ( $\geq 99.9\%Cu$ ).
- Surface: uncoated or tinned.
- Resistivity:  $\leq 1.785\mu\Omega\text{cm}^2/\text{cm}$ .
- Electrical conductivity:  $\geq 55\text{ Sm/mm}^2$ .
- Tensile strength:  $\geq 200\text{N/mm}^2$ .
- Extensibility:  $\geq 30\%$ .

### Technical data of insulation

- Material: PVC. Color: black.
- Thickness: 1.8-2.1mm.
- Shore hardness: A70-80.
- Electrical strength:  $\geq 23\text{kV/mm}$ .
- Oxygen index: 30%.
- Flame retardant; self-extinguishing.
- Elasticity:  $\geq 180\%$  after 7-day aging-test with  $135^\circ\text{C}$ .
- Tensile strength:  $\geq 20\text{MPa}$ .

### Technical data of flexible insulated busbars

- Operating temperature:  $-30^\circ\text{C}$  to  $+105^\circ\text{C}$ .
- Operating voltage: 750V.
- Voltage withstand performance with 15min / 50Hz AC:
  - between flexible insulated busbar and earth:  $\geq 15\text{kV}$ .
  - between two flexible insulated busbars:  $\geq 30\text{kV}$ .

Dimensions and Qty. of strips	Cross section (mm <sup>2</sup> )	Ampacity (A)			Dimensions and Qty. of strips	Cross section (mm <sup>2</sup> )	Ampacity (A)		
		$\triangle$ T=20K (3)	$\triangle$ T=40K (4)	$\triangle$ T=50K (5)			$\triangle$ T=20K (3)	$\triangle$ T=40K (4)	$\triangle$ T=50K (5)
15.5 x 0.8 x 2	24.8	125	175	200	40 x 1 x 2	80	240	330	380
15.5 x 0.8 x 3	37.2	160	210	240	40 x 1 x 3	120	330	480	540
15.5 x 0.8 x 4	49.6	195	265	295	40 x 1 x 4	160	400	560	630
15.5 x 0.8 x 6	74.4	225	320	360	40 x 1 x 5	200	450	630	710
15.5 x 0.8 x 8	99.2	265	380	430	40 x 1 x 6	240	480	680	750
15.5 x 0.8 x 10	124	300	420	480	40 x 1 x 8	320	600	830	920
20 x 1 x 2	40	170	240	270	40 x 1 x 10	400	670	920	1030
20 x 1 x 3	60	230	320	360	50 x 1 x 3	150	400	570	650
20 x 1 x 4	80	270	380	440	50 x 1 x 4	200	490	700	790
20 x 1 x 5	100	300	430	490	50 x 1 x 5	250	540	780	880
20 x 1 x 6	120	330	470	530	50 x 1 x 6	300	590	840	950
20 x 1 x 8	160	400	560	620	50 x 1 x 8	400	680	1000	1130
20 x 1 x 10	200	420	580	650	50 x 1 x 10	500	750	1100	1300
24 x 1 x 2	48	200	280	320	63 x 1 x 5	315	650	900	1000
24 x 1 x 3	72	250	360	410	63 x 1 x 6	378	690	980	1100
24 x 1 x 4	96	280	410	460	63 x 1 x 8	504	840	1200	1350
24 x 1 x 5	120	330	470	530	63 x 1 x 10	630	920	1300	1450
24 x 1 x 6	144	360	510	570	80 x 1 x 5	400	700	1100	1230
24 x 1 x 8	192	420	590	670	80 x 1 x 6	480	780	1210	1360
24 x 1 x 10	240	500	700	790	80 x 1 x 8	640	950	1400	1570
32 x 1 x 2	64	230	320	360	80 x 1 x 10	800	1090	1550	1730
32 x 1 x 3	96	280	410	460	100 x 1 x 5	500	860	1250	1400
32 x 1 x 4	128	320	460	520	100 x 1 x 6	600	950	1380	1530
32 x 1 x 5	160	390	550	610	100 x 1 x 8	800	1100	1580	1760
32 x 1 x 6	192	440	620	700	100 x 1 x 10	1000	1220	1710	1920
32 x 1 x 8	256	510	720	822	100 x 1 x 12	1200	1300	1800	2010
32 x 1 x 10	320	600	840	930					

# Busbar Insulator

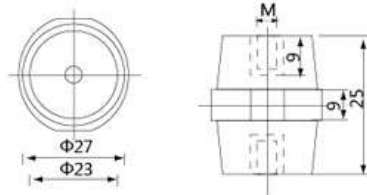

Tensile strength(LBS)	500
Torgue strength(LBS)	6
Voltage withstand(KV)	6
screw(mm)	6
weight(G)	28

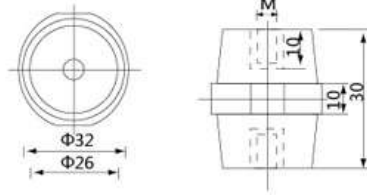

Tensile strength(LBS)	550
Torgue strength(LBS)	8
Voltage withstand(KV)	8
screw(mm)	8
weight(G)	44

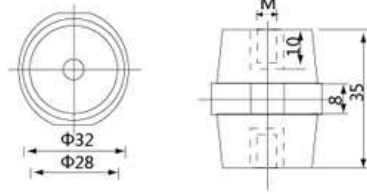

Tensile strength(LBS)	800
Torgue strength(LBS)	10
Voltage withstand(KV)	10
screw(mm)	8
weight(G)	50

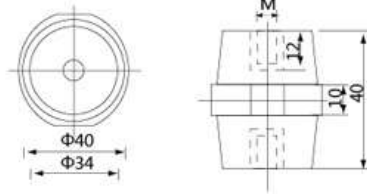

Tensile strength(LBS)	650
Torgue strength(LBS)	10
Voltage withstand(KV)	12
screw(mm)	8
weight(G)	86

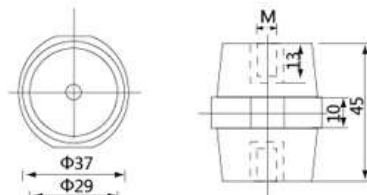

Tensile strength(LBS)	1000
Torgue strength(LBS)	20
Voltage withstand(KV)	15
screw(mm)	10
weight(G)	70

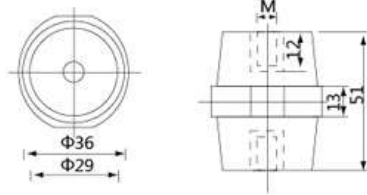

Tensile strength(LBS)	1000
Torgue strength(LBS)	20
Voltage withstand(KV)	15
screw(mm)	8
weight(G)	83

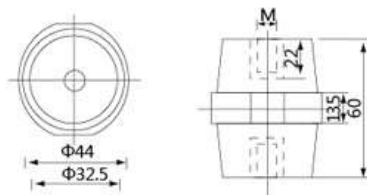

Tensile strength(LBS)	1500
Torgue strength(LBS)	40
Voltage withstand(KV)	25
screw(mm)	10
weight(G)	170

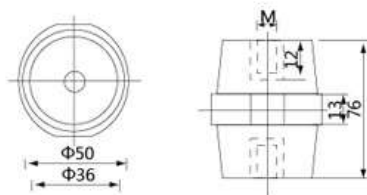

Tensile strength(LBS)	1500
Torgue strength(LBS)	40
Voltage withstand(KV)	25
screw(mm)	10
weight(G)	233

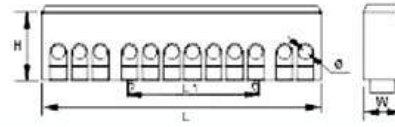
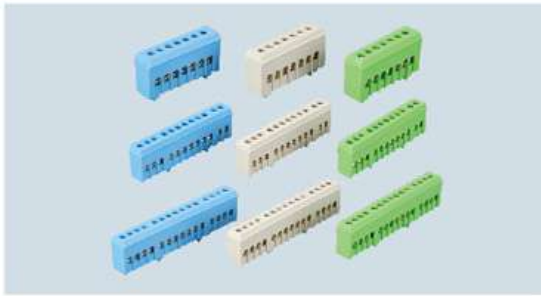

Item no.	Spec. w x h -hole	L1	L2	H	W	Φ	screw size	Plastic setting
		mm						
LK 032-01	6x9-7	53.0	35.0	26.3	13.0	5.2	M5.0	PA
LK 032-02	6x9-12	88.0	35.0	26.3	13.0	5.2	M5.0	PA
LK 032-03	6x9-15	108.0	35.0	26.3	13.0	5.2	M5.0	PA

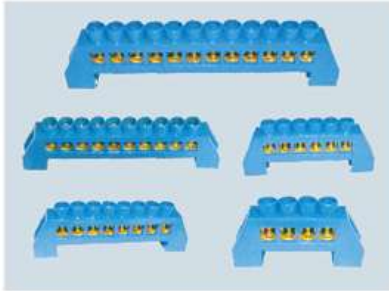

There are 8x12 copper rows in insulating crust

- D-8x12/12 Potential**
- D-8x12/10 Potential**
- D-8x12/8 Potential**
- D-8x12/6 Potential**
- D-8x12/4 Potential**

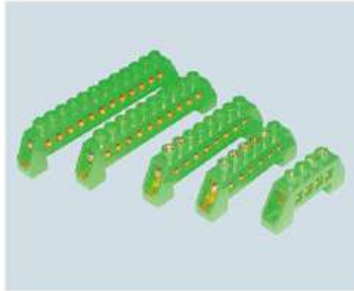

G-8x12 copper rows in insulating crust with earthing in one end.

- G-8x12/12 Potential**
- G-8x12/10 Potential**
- G-8x12/8 Potential**
- G-8x12/6 Potential**
- G-8x12/4 Potential**

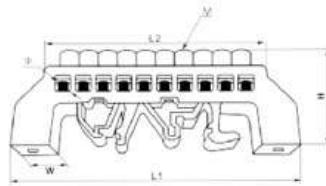
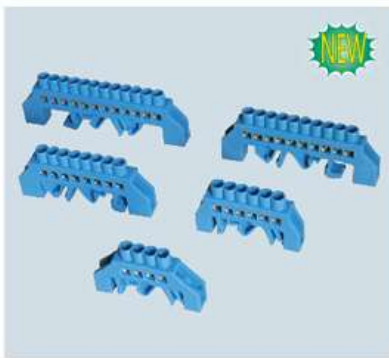

Item no.	Spec. w x h -hole	L1	L2	H	W	Φ	screw size	Plastic setting
		mm						
LK 033-01	6x9-4	57.5	34	34.5	10.5	5.0	M4	PA
LK 033-02	6x9-6	57.7	46.7	34.5	10.5	5.0	M4	PA
LK 033-03	6x9-8	78.5	60	34.5	10.5	5.0	M4	PA
LK 033-04	6x9-10	89	72.8	34.5	10.5	5.0	M4	PA
LK 033-05	6x9-12	102	85.7	34.5	10.5	5.0	M4	PA
LK 033-06	8x12-4	77.5	40.6	38.6	12.6	7.0	M5	PA
LK 033-07	8x12-6	77.5	57.3	38.6	12.6	7.0	M5	PA
LK 033-08	8x12-8	94.3	74.4	38.6	12.6	7.0	M5	PA
LK 033-09	8x12-10	111.0	91	38.6	12.6	7.0	M5	PA
LK 033-10	8x12-12	128.4	108.6	38.6	12.6	7.0	M5	PA
LK 033-11	8x12-14	145.8	135.6	38.6	12.6	7.0	M5	PA

## DRB series

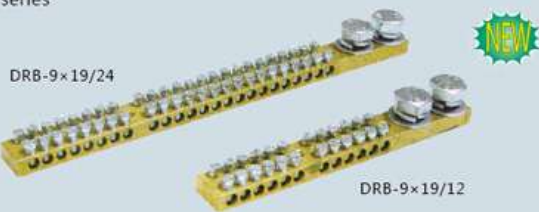

## Double row brass terminal series

Model No.	Way	Brass specification (mm)	Rated current (A)	Dimension (mm)	Screw no.s	Installation hole Distance (mm)
DRB-9x19/6	6	9x19	180A	102x45x45	2 x M10 12 x M5	50 (M5)
DRB-9x19/12	12	9x19	180A	144x45x45	2 x M10 24 x M5	50 (M5)
DRB-9x19/18	18	9x19	180A	187x45x45	2 x M10 36 x M5	120 (M5)
DRB-9x19/24	24	9x19	180A	230x45x45	2 x M10 48 x M5	120 (M5)
DRB-9x19/36	36	9x19	180A	315x45x45	2 x M10 72 x M5	120 (M5)

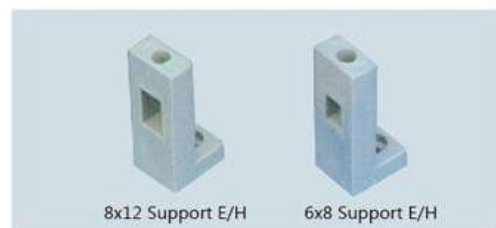
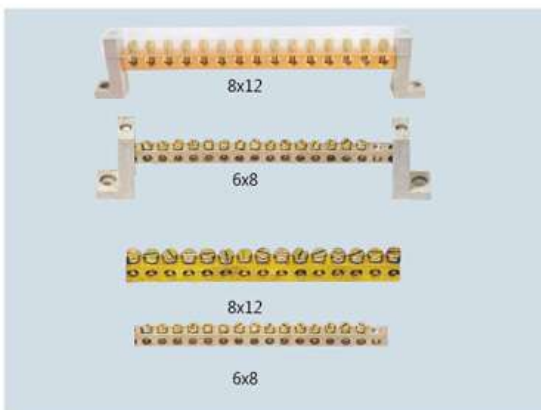

Busbar plated or not for lmeter.

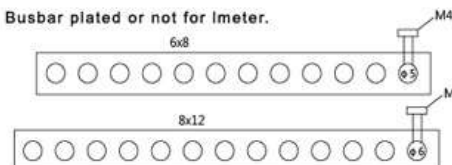

# Busbar Terminal / Cable Clamp Series

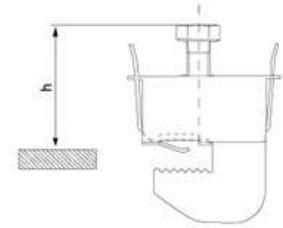
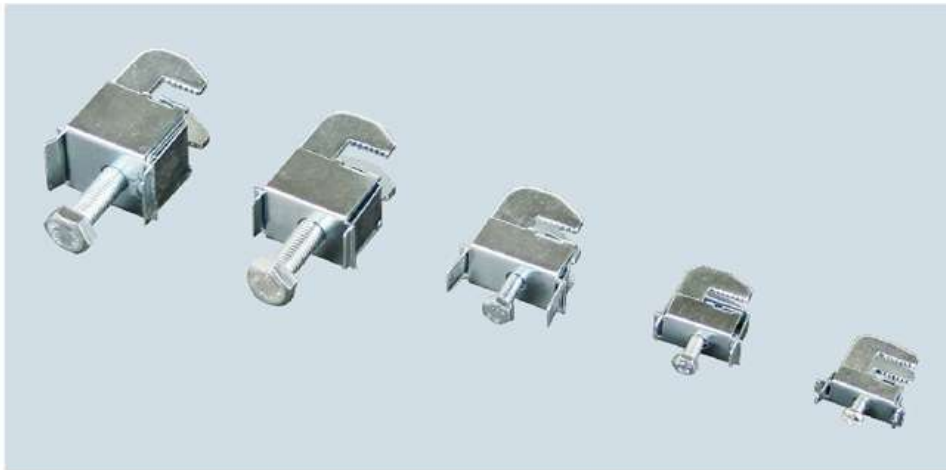

SV Busbar terminal

Minimum H (mm)	Maximum H (mm)	Model NO.
17	23	SV201/206
22	29	SV202/207
26	39	SV203/208
39	57	SV204/209
44	66	SV205/210

Thickness of bus	Round lead wiring*	Piled copper bus terminal space	Torque	Per package	Model NO.
4-5mm	1-4mm <sup>2</sup>	-	2Nm	50pcs	SV201
4-5mm	2.5-16mm <sup>2</sup>	8 x 8mm	3Nm	50pcs	SV202
4-5mm	16-50mm <sup>2</sup>	10.5 x 11mm	6-8Nm	50pcs	SV203
4-5mm	35-70mm <sup>2</sup>	16.5 x 15mm	10-12Nm	50pcs	SV204
4-5mm	70-185mm <sup>2</sup>	22.5 x 20mm	12-15Nm	50pcs	SV205
9-10mm	1-4mm <sup>2</sup>	-	2Nm	50pcs	SV206
9-10mm	2.5-16mm <sup>2</sup>	8 x 8mm	3Nm	50pcs	SV207
9-10mm	16-50mm <sup>2</sup>	10.5 x 11mm	6-8Nm	50pcs	SV208
9-10mm	35-70mm <sup>2</sup>	16.5 x 15mm	10-12Nm	50pcs	SV209
9-10mm	70-185mm <sup>2</sup>	22.5 x 20mm	12-15Nm	50pcs	SV210



for busbars	Connection	Terminal space	For use	Pack size	Weight	Model NO.	Part no.
	min.-max.	WxH	up to max.		kg/100u.		
5mm flat busbars	1.5-16	7.5x7.5	180A	100	2.1	LK401	01 284
	4-35	10.5x11	270A	50	4.6	LK402	01 285
	16-70	14x14	400A	25	7.1	LK403	01 287
	16-120	17x15	440A	25	10.6	LK404	01 068
10mm flat busbars	1.5-16	7.5x7.5	180A	100	2.3	LK405	01 289
	4-35	10.5x11	270A	50	4.7	LK406	01 290
10mm flat busbars, double-T and triple-T section	16-70	14x14	400A	25	7.5	LK407	01 292
	16-120	17x15	440A	25	10.9	SV408	01 203

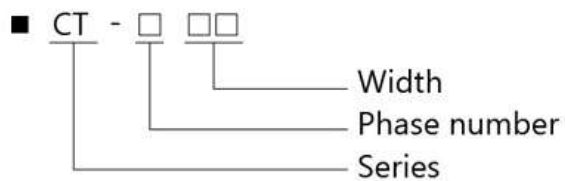
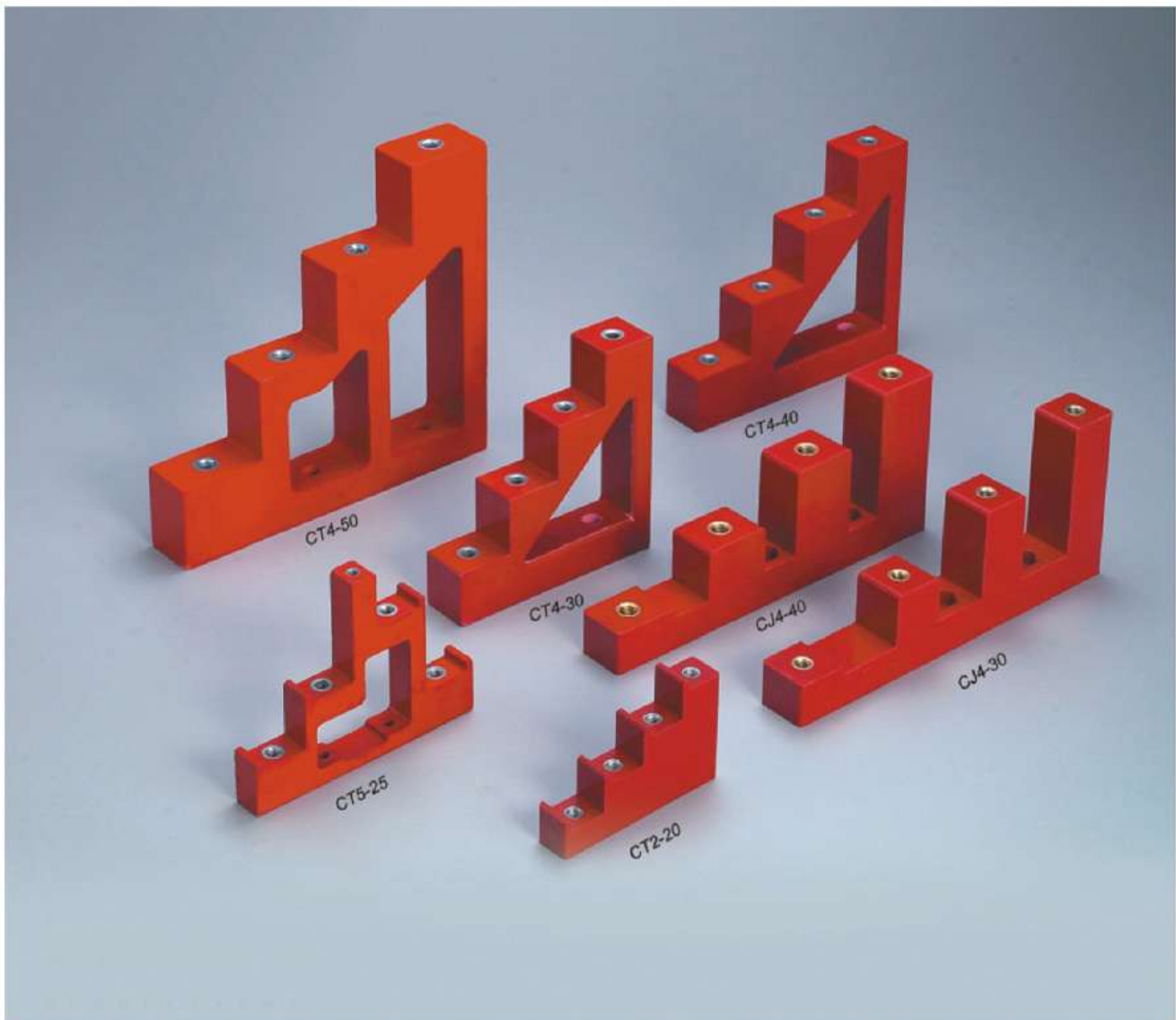

- Operating Temperature:-40~+140
- Insert:Brass.Steel with Zn coating
- Material:BMC(Bough Moulding Compound)  
SMC(Sheet Moulding Compound)
- Colour,Insert,material In capability accordance with customer needs

## STEP INSULATORS

CT2-15

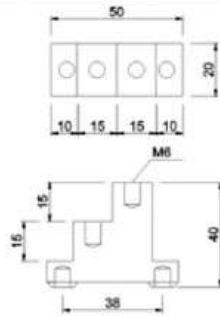

CT4-40

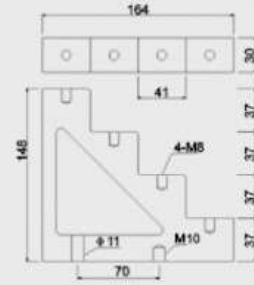

CT2-20

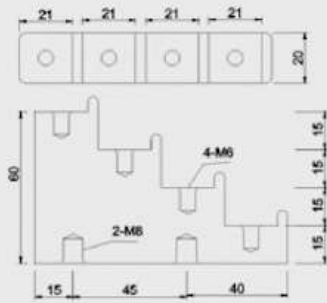

CT4-50

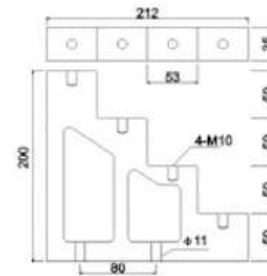

CT2-25



CJ4-30

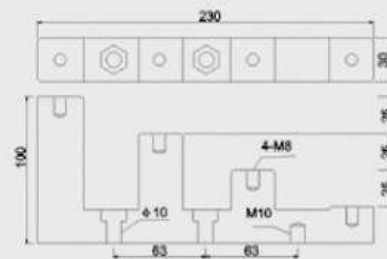

CT5-25

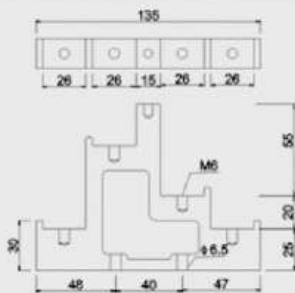

CJ4-40

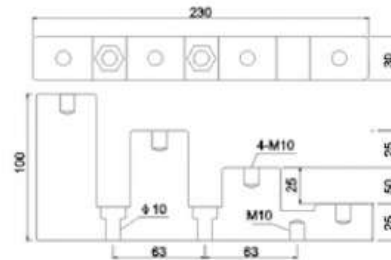

CT4-30

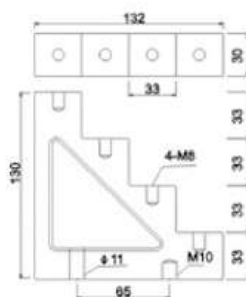

CJ-50

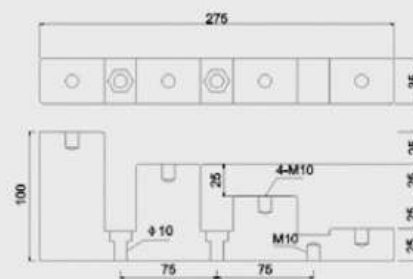

**L-UD/R VD/R**

PC+ABS, Halogen free ,low smoke, New type reinforced wiring ducts

Description:

**Materials**

PC+ABS,halogen free,Low smoke,RoHs compliant,Insulating material;  
Electric safety,Fire safety.  
Flammability rating: UL 94 V-O

**Construction:**

- 1.Sides get thick,enhanced gradually from top to bottom, and improving sides' strength and reliability.
- 2.Double layers are applied to the joint of cover and sides, making it easier to disassemble but more secured.
- 3.The indent bottom right angel is easy to be folded. While connecting with the veritical duct by cutting two end to form straight, flat outlets, fully protect the cable.
- 4.The floor is with rails,allowing to add traps to tighten wires and make it organized,neat and save space.

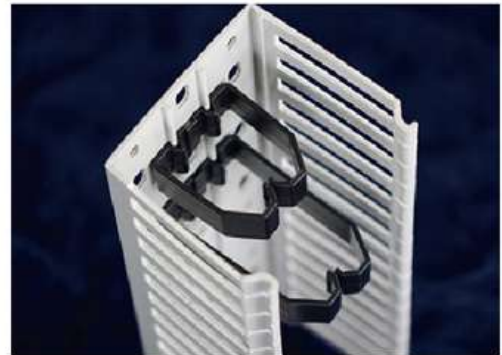
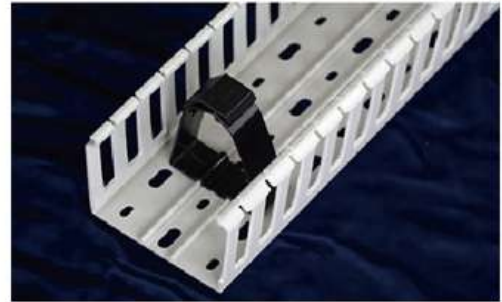
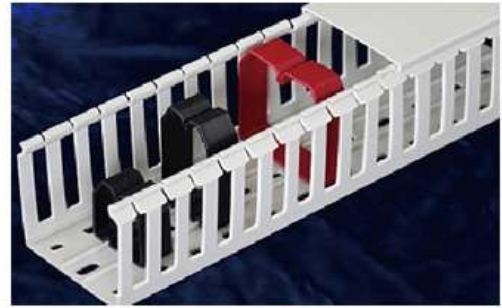

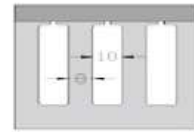

## L-UD/R series low smoke halogon free wiring ducts ( reinforced)

Type	Specification		Slot Width mm	Sliver Width mm	Wires to be Contained	Packing M
	H(mm)	W(mm)				
L-UD/R 25/25	25	25	10	10	10-25pcs	100
L-UD/R 37.5/37.5	37.5	37.5	10	10	60-70pcs	100
L-UD/R 50/25	50	25	10	10	20-30pcs	100
L-UD/R 50/37.5		37.5	10	10	20-35pcs	80
L-UD/R 50/50		50	10	10	80-90pcs	80
L-UD/R 50/75		75	10	10	180-200pcs	48
L-UD/R 50/100		100	10	10	220-250pcs	48
L-UD/R 75/25	75	25	10	10	50-55pcs	60
L-UD/R 75/37.5		37.5	10	10	110-115pcs	60
L-UD/R 75/50		50	10	10	180-200pcs	48
L-UD/R 75/75		75	10	10	200-240pcs	36
L-UD/R 75/100		100	10	10	260-320pcs	24

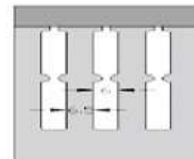

## L-VD/R series low smoke halogon free wiring ducts ( reinforced)

Type	Specification		Slot Width mm	Sliver Width mm	Wires to be Contained	Packing M
	H(mm)	W(mm)				
L-VD/R 25/25	25	25	6	6.5	10-25pcs	100
L-VD/R 37.5/37.5	37.5	37.5	6	6.5	60-70pcs	100
L-VD/R 50/25	50	25	6	6.5	20-30pcs	100
L-VD/R 50/37.5		37.5	6	6.5	20-35pcs	80
L-VD/R 50/50		50	6	6.5	80-90pcs	80
L-VD/R 50/75		75	6	6.5	180-200pcs	48
L-VD/R 50/100		100	6	6.5	220-250PCS	48
L-VD/R 75/25	75	25	6	6.5	50-55pcs	60
L-VD/R 75/37.5		37.5	6	6.5	110-115pcs	60
L-VD/R 75/50		50	6	6.5	180-200pcs	48
L-VD/R 75/75		75	6	6.5	200-240pcs	36
L-VD/R 75/100		100	6	6.5	260-320pcs	24

Sectional view



bottom with single holes for width less than 75mm

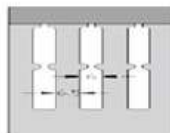
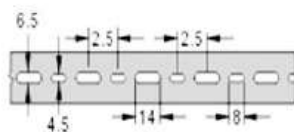

bottom with triple holes for width over 75mm

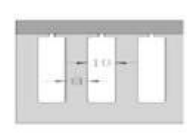
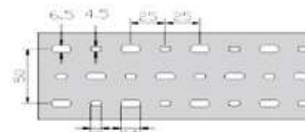



**FLEXIBLE DUCTS  
SELF-ADHESIVE**

Material: Polypropylene  
self-extinguishing

Color: GREY  
RAL 7030

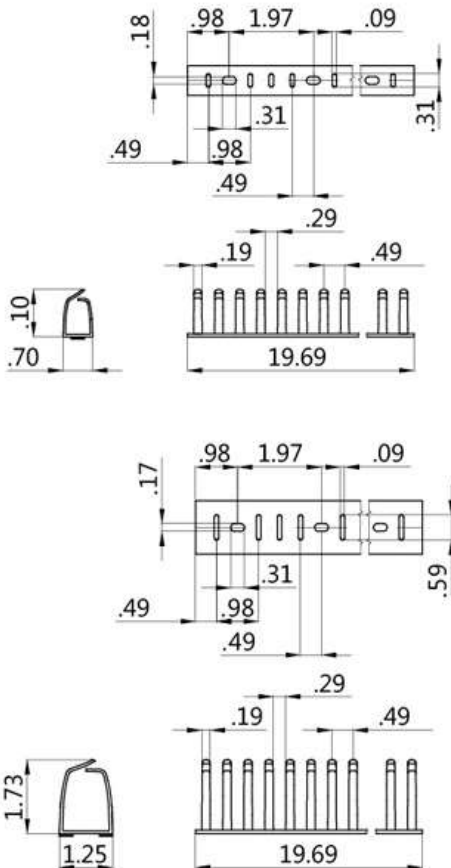

LK-FLEX Duct is a unique product offering from LINKWELL that is a flexible, resilient and efficient harnessing solution to your wiring needs. For wiring to cabinet doors, from control panels and for electronic equipment. For that part of the cable run that leans against the side of the control cabinet.

◆ Due to the flexibility of the material individual wires can easily be added, or removed from total wires within the duct.

◆ Since Dinosaur has no cover it can accommodate cables in restricted space applications, and also effectively removes the need for cable ties.

◆ It can be used in extreme operating conditions (i.e. max. temp. up to 176°F) and has excellent resistance to radiation if exposed to a nuclear environment.

◆ LK-FLEX withstands mechanical stress when installed (i.e. earthquake, falling equipment) while in the event of fire does not emit corrosive, nor toxic gases, and smoke development is minimal.

◆ The duct can be cut to desired length using scissors or knife. When applying the LK-FLEX with adhesive tape, it is necessary to make sure that the surface is perfectly clean and dry.

Catalog Numbe	Nominal Size	Lengths* per Carton
LK 25AG	0.5	0.7524
LK 35AG	1.00	1.3824
LK 45AG	1.38	1.7514

\* Each length is 19.7 inches (500 mm)

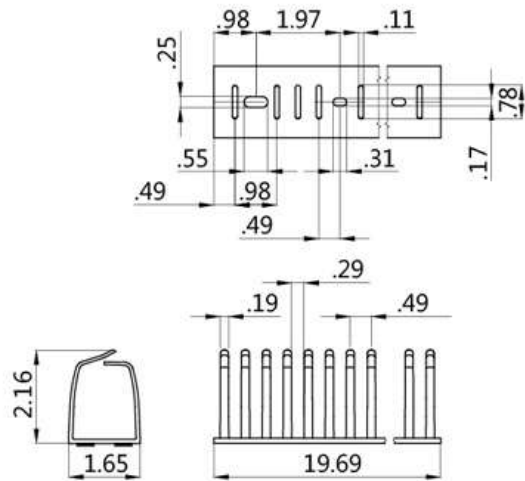

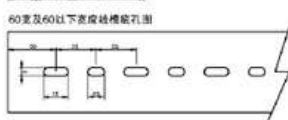
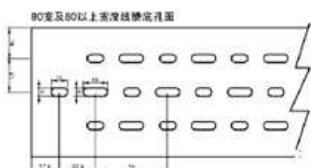
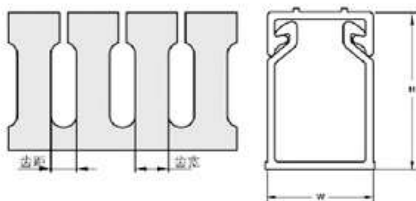
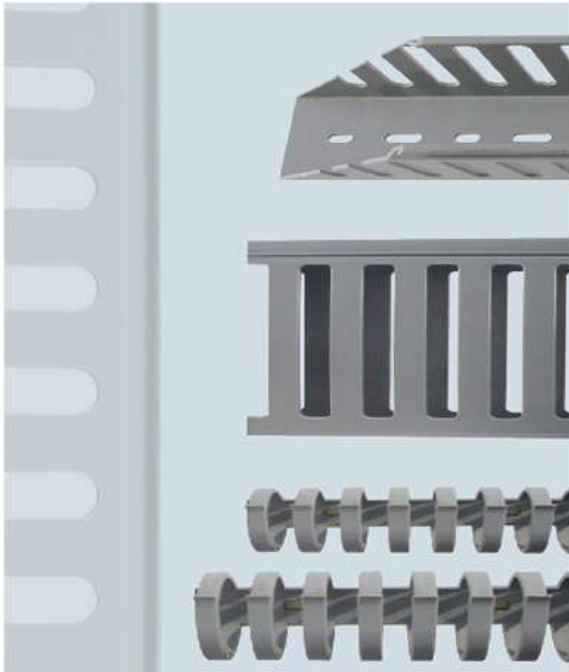

国际系列选型: SWD 高H/宽W

## Description

### Material

Manufactured with high quality rigid PVC, ROHS compliant, low smoke

### Flammability rating

UL94 Flammability Rating of V-0, inflaming retarding material with good self extinguishing ability

### Construction

1. Consist of base and cover, Easy and firm snap-on assembly, smooth joining for a better finish
2. With aligned slot, Smooth corners and edges will not damage or disfigure wires.
3. Variable sizes and multi type side holes, easily for installation and wiring digrame.
4. Special mark line design on the cover can allow a quick tag of relevant components.

### Color

Grey (White. Blue. and Black colors are available)

### Temperature

-20°C ~ 85°C

### LD series

Wide slot/finger	Dimension		Teeth space/Teeth width (mm)			package meter
	TYPE	H(mm)	W(mm)	6-8	8-10	
LD 50 25	50	25	•			100
LD 50 35		35	•			100
LD 50 45		45	•			80
LD 50 50		50	•			80
LD 50 60		60	•			64
LD 50 80		80	•			48
LD 60 40	60	40		•		64
LD 60 60		60		•		48
LD 60 80		80			•	36
LD 65 33	65	33		•		80
LD 65 45		45		•		80
LD 65 65		65			•	48
LD 80 25	80	25		•		60
LD 80 35		35		•		60
LD 80 40		40			•	48
LD 80 45		45			•	48
LD 80 50		50			•	48
LD 80 60		60			•	36
LD 80 80		80			•	36
LD 80 100		100			•	24
LD 80 120		120			•	24
LD 100 35		100	35			•
LD 100 40	40				•	48
LD 100 50	50				•	48
LD 100 60	60				•	36
LD 100 80	80				•	24
LD 100 100	100				•	24
LD 100 120	120				•	24
LD 100 140	140				•	24
LD 130 100	130	100			•	24

## LFD series

Round	DimensiOfns		Teeth space/Teeth width (mm)			package
	TYPE	H(mm)	W(mm)	6-6	6-8	10-10
LFD 50 25	50	25	•		•	100
LFD 50 35		35	•		•	100
LFD 50 45		45	•		•	80
LFD 50 50		50	•		•	80
LFD 50 60		60	•		•	64
LFD 50 80		80	•		•	48
LFD 80 25	80	25		•		60
LFD 80 35		35		•		60
LFD 80 40		40		•		48
LFD 80 45		45		•		48
LFD 80 50		50		•		48
LFD 80 60		60		•		36
LFD 80 80		80		•		36
LFD 80 100		100		•		24
LFD 80 120		120		•		24

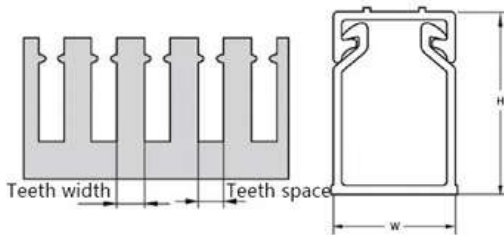

Bottom view for duct above 80mm(width)

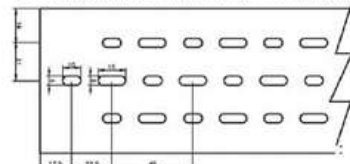

Bottom view for duct below 60mm(width)

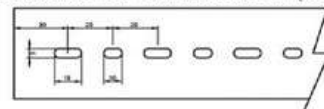

## KFD series

Close/Square	DimensiOfns		Teeth space/Teeth width (mm)			package
	TYPE	H(mm)	W(mm)	6-6	6-8	10-10
KFD 60 40	60	40	•			64
KFD 60 60		60	•			48
KFD 60 80		80	•			36
KFD 100 30	100	35			•	48
KFD 100 40		40			•	48
KFD 100 50		50			•	48
KFD 100 60		60			•	36
KFD 100 80		80			•	24
KFD 100 100		100			•	24
KFD 100 120		120			•	24
KFD 100 140		140			•	24
KFD 150 100	150	100			•	16

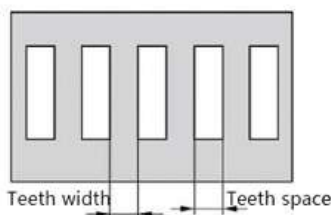

Bottom view for duct above 80mm(width)

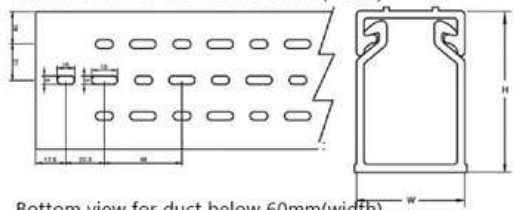

Bottom view for duct below 60mm(width)

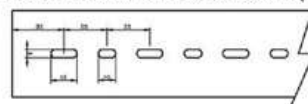

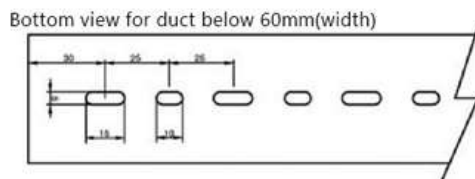
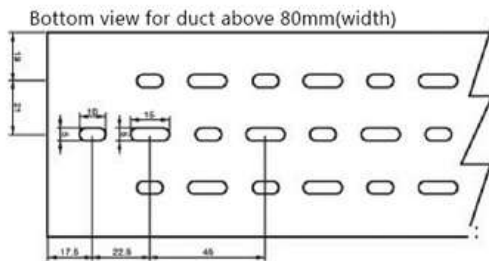
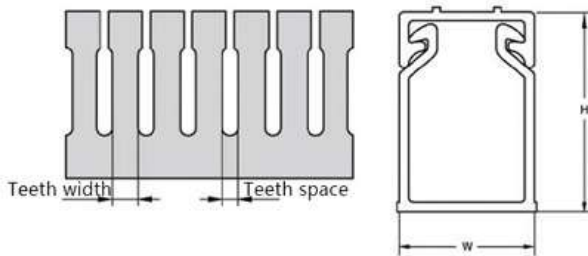
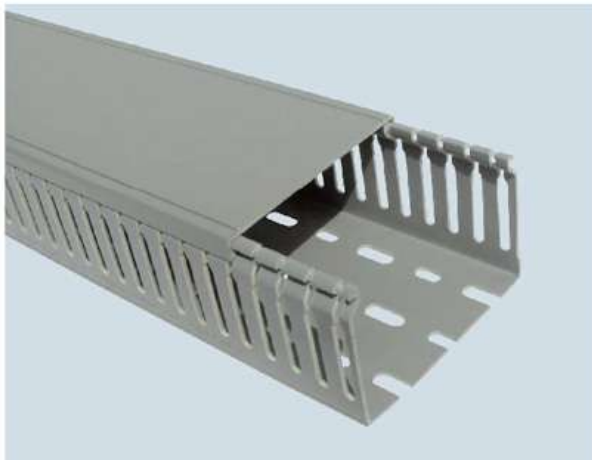

## KD series

Narrow Slot/Finger TYPE	Dimension		Teeth space/Teeth width (mm)			Package meter
	H(mm)	W(mm)	4-6	6-6	6-8	
KD 25 25	25	25	•			100
KD 30 20	30	20	•			100
KD 30 35		35	•			100
KD 30 30		30	•			100
KD 30 35		35	•			100
KD 35 35	35	35	•			100
KD 40 25	40	25	•			100
KD 40 40		40	•			80
KD 40 60		60	•			60
KD 50 25	50	25	•			100
KD 50 35		35	•			100
KD 50 45		45	•			80
KD 50 50		50	•			80
KD 50 60		60	•			64
KD 50 80		80	•			48
KD 60 40	60	40	•			64
KD 60 60		60	•			48
KD 60 80		80	•			36
KD 65 33	65	33	•			80
KD 65 45		45	•			80
KD 65 65		65	•			48
KD 80 25	80	25	•		•	60
KD 80 35		35	•		•	60
KD 80 40		40	•		•	48
KD 80 45		45	•		•	48
KD 80 50		50	•		•	48
KD 80 60		60	•		•	36
KD 80 80		80	•		•	36
KD 80 100		100	•		•	24
KD 80 120		120	•		•	24
KD 100 35		100	35		•	
KD 100 40	40			•		48
KD 100 50	50			•		48
KD 100 60	60			•		36
KD 100 80	80			•		24
KD 100 100	100			•		24
KD 100 120	120			•		24

**MKD series**

Close Type	Dimension		Package
	H(mm)	W(mm)	meter
TYPE			
MKD 25 25	25	25	100
MKD 30 20	30	20	100
MKD 30 35		35	100
MKD 30 30		30	100
MKD 30 35		35	100
MKD 35 35	35	35	100
MKD 40 25	40	25	100
MKD 40 40		40	80
MKD 40 60		60	60
MKD 50 25	50	25	100
MKD 50 35		35	100
MKD 50 45		45	80
MKD 50 50		50	80
MKD 50 60		60	64
MKD 50 80		80	48
MKD 60 40	60	40	64
MKD 60 60		60	48
MKD 60 80		80	36
MKD 65 33	65	33	80
MKD 65 45		45	80
MKD 65 65		65	48
MKD 80 25	80	25	60
MKD 80 35		35	60
MKD 80 40		40	48
MKD 80 45		45	48
MKD 80 50		50	48
MKD 80 60		60	36
MKD 80 80		80	36
MKD 80 100		100	24
MKD 80 120	120	24	
MKD 100 35	100	35	48
MKD 100 40		40	48
MKD 100 50		50	48
MKD 100 60		60	36
MKD 100 80		80	24
MKD 100 100		100	24
MKD 100 120		120	24
MKD 100 140	140	24	
MKD 130 100	130	100	24
MKD 150 100	150	100	16

**Cover**  
 Model: KB-width

Art. No	Art. No	Art. No	Art. No
KB-15	KB-35	KB-60	KB-120
KB-20	KB-40	KB-65	KB-140
KB-25	KB-45	KB-80	KB-535
KB-30	KB-50	KB-100	
KB-33	KB-55		

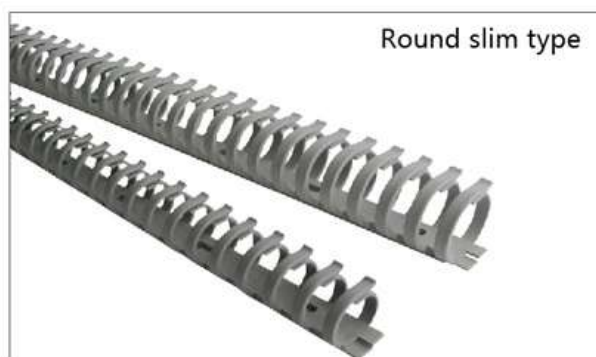

Round slim type

**Round slim type**  
 Material: NYLON66 ( grey )

Wide teeth	Dimensiofns		
	W	H	L
TYPE			
FD-20	20.4	14.4	50cm
FD-30	29	24.9	50cm
FD-40	39	36	50cm



## Application

LK12-W Series LED light is designed for instrument cabinet illumination of various switchgear, built in infrared sensor switch , and simplify the user's application design.

## Features and advantage

- Built in infrared sensor switch , the user do not install additional switch.
- Economize on energy, In the case of illuminate effect same alike the traditional light, economizing on energy is 75% above.
- Life span is long, the LED light source, someone call it the longevity light, meaning to extinguish never. It's the solid cold light source, adopt a special electric circuit design, the life span can reach to for 100,000 hours, comparing traditional light source life span to grow 1000% above.
- The environmental protection performance is better, without ultraviolet ray and infrared rays in the spectrum, without calories and radiate, the dizzy light is small, and the castoff can recover, without pollution and do not contain the mercury chemical Element. The cold light source, can be touched, belong to typical model of the green illuminate light source.
- Special circuit design, if anyone LED is bad, it isn't without influence to normal illumination of others LED.
- Special structure design, light body position can be adjusted, that solves the problem of less illumination angle of LED.

## Technique parameters

Power supply	AC(50/60Hz)/DC (80-265V), or other voltage customer demand.
Average illuminance at 300mm from lamp	>300lx
Color rendering index Ra	> 85
Switch	built in infrared switch, active distance 20~80mm
Terminal	screw terminal, 0.5mm <sup>2</sup> ~2.5mm <sup>2</sup>
Working environment temperature	-25℃ ~+55℃
Fix method	Two hole fixation
Color of the light	white
Protection class	IP20
Withstand voltage	AC2500V, 1Min
luminescence component	LED
Rated humidity	25%~95%
Life span	More than 100,000hours
Power	6W

**Models explanation**
**LK 12 - W - □**

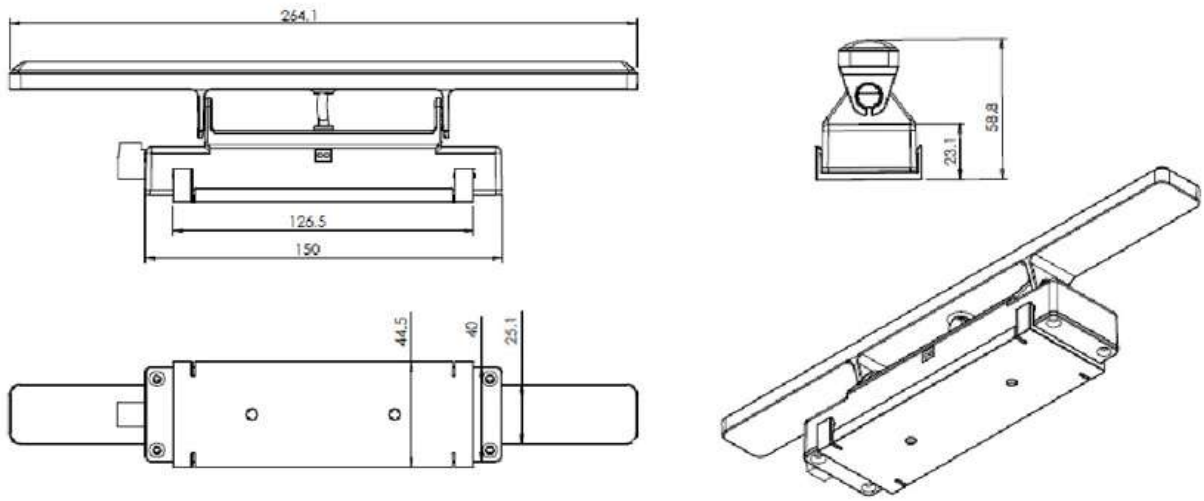
**Dimension**

**Installation**

Installation: first fix the fixed plate on the position that the lamp need to be install , and then push the lamp into the fixed plate to complete the installation.

Remove: use a screwdriver to remove 4 bayonet from the slot of the fixed plate, and then extract the lamp to complete the disassembly.

Fixed screw: Slotted countersunk flat head screws (common head style), M4\*8, ISO 2009

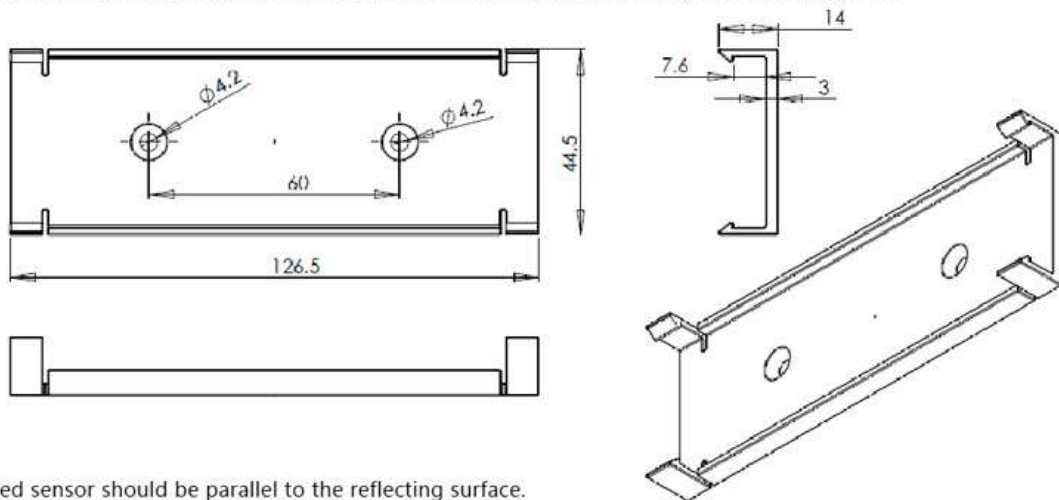
The following drawing specify a fixed plate size , please use this drawing to design the mounting hole.



Note: Infrared sensor should be parallel to the reflecting surface.



Infrared sensor



## Application

LK13-W Series LED light is designed for instrument cabinet illumination of various switchgear, built in switch, and simplify the user's application design.

## Features and advantage

- Built in switch, the user do not install additional switch.
- Economize on energy, In the case of Illuminate effect same alike the traditional light, economizing on energy is 75% above.
- Life span is long, the LED light source, someone call it the longevity light, meaning to extinguish never. It's the solid cold light source, adopt a special electric circuit design, the life span can reach to for 100,000 hours, comparing traditional light source life span to grow 1000% above.
- The environmental protection performance is better, without ultraviolet ray and infrared rays in the spectrum, without calories and radiate, the dizzy light is small, and the castoff can recover, without pollution and do not contain the mercury chemical Element. The cold light source, can be touched, belong to typical model of the green illuminate light source.
- Special circuit design, if anyone LED is bad, it isn't without influence to normal illumination of others LED.
- Special structure design, light body position can be adjusted, that solves the problem of less illumination angle of LED.

## Technique parameters

Power supply	AC(50/60Hz)/DC (80-265V), or other voltage customer demand.
Average illuminance at 300mm from lamp	> 300lx
Color rendering index Ra	> 85
Switch	built in switch
Terminal	screw terminal, 0.5mm <sup>2</sup> ~2.5mm <sup>2</sup>
Working environment temperature	-25℃~+55℃
Fix method	Two hole fixation,
Color of the light	white
Protection class	IP20
Withstand voltage	AC2500V, 1Min
luminescence component	LED
Rated humidity	25%~95%
Life span	More than 100,000hours
Power	6W

**Models explanation**
**LK 13 - W - □**

Voltage code A: AC(50/60Hz)/DC (80-265V), C: DC48V, D: DC24V

Light color: White

Design number

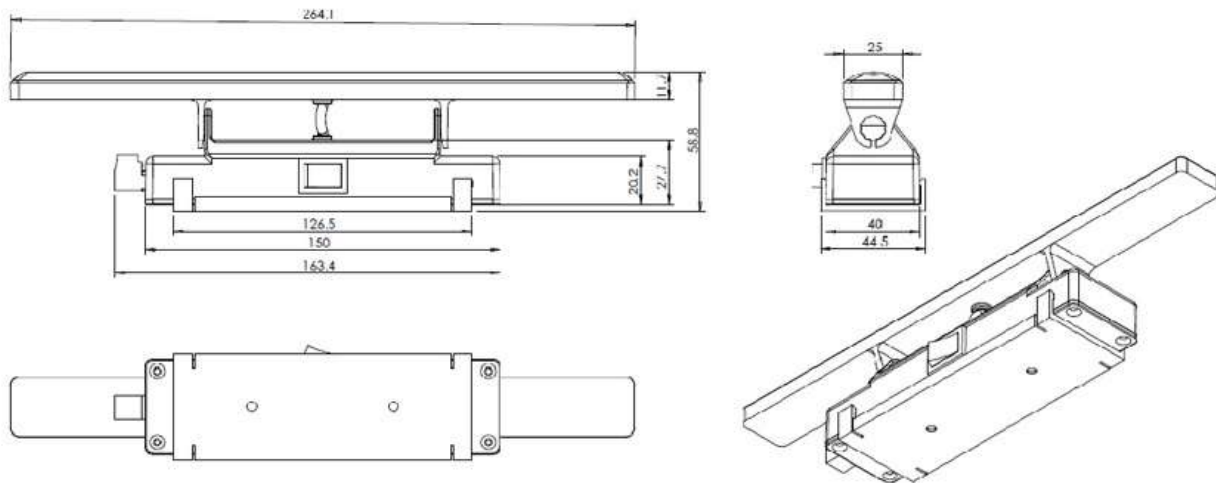
**Dimension**

**Installation**

Installation: first fix the fixed plate on the position that the lamp need to be install , and then push the lamp into the fixed plate to complete the installation.

Remove: use a screwdriver to remove 4 bayonet from the slot of the fixed plate, and then extract the lamp to complete the disassembly.

Fixed screw: Slotted countersunk flat head screws (common head style), M4\*8, ISO 2009

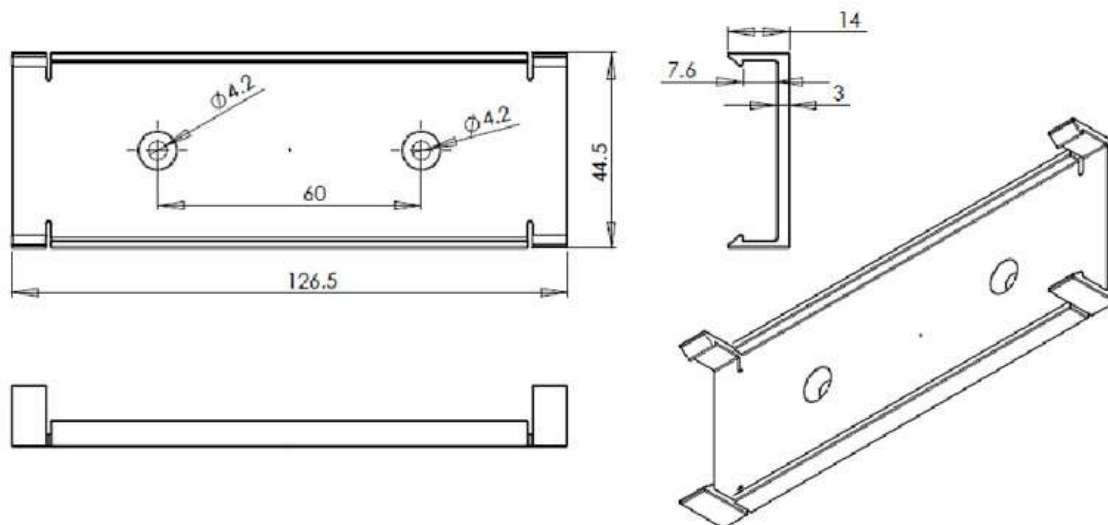
The following drawing specify a fixed plate size , please use this drawing to design the mounting hole.



# KCL250-5/KCL400-5 LED Emergency Light for Switchgear Manuals



Product Name: LED Emergency light for Switchgear, Input Voltage: USB5V  
Product Code: KCL250-5 (250mm)  
KCL400-5 (400mm)

#### Product Features:

1. Adopting the technology of P.I.R infrared motion and photosensitive sensor.
2. Mounting: Magnetic fixing, or with screws
3. Power: Charging by USB5V or 220V power.
4. Using new type LED light source, with the performance of high brightness, low attenuation, long lifetime up to 3000h and high reliability.

#### Instruction for Switches :

Switch on: Long press switch for 2 seconds

Switch off: Long press switch for 2 seconds

1<sup>st</sup> Gear: switch off, the default mode for the light

2<sup>nd</sup> Gear: constant light , the light on state

(Adjusting method: Long press 2 seconds in 1<sup>st</sup> gear state)

3<sup>rd</sup> Gear: induction power -saving mode(40% brightness)

(Adjusting method: Press ON-OFF switch in 2<sup>nd</sup> gear state)

4<sup>th</sup> Gear: induction mode(100% brightness)

(Adjusting method: Press ON-OFF switch in 3<sup>rd</sup> gear state, the green indicator light automatically on.)

Note: the 3<sup>rd</sup> Gear and 4<sup>th</sup> gear requires the ambient brightness less than 3LUX, the distance between the light and human within 3m, then get lighting automatically, and turns off with 20s delay after leaving,.

#### Operation Time:

2<sup>nd</sup> gear: 5 continuous working hours

3<sup>rd</sup> gear: constant light state, 12.5 continuous working hours, the actual working time depends on the lighting time.

4<sup>th</sup> gear: constant light state, 5 continuous working hours, the actual working time depends on the lighting time.

(All above working time should be calculated in the full charging state)

#### Charging instructions:

In-Charge: Blue indicator light on

Full-Charge: Red indicator light on

Charging time: approximately 4-6 hours

Dimension diagram

KCL250-5

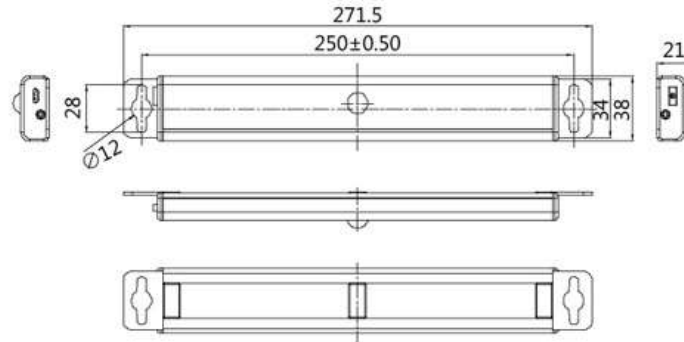

KCL400-5

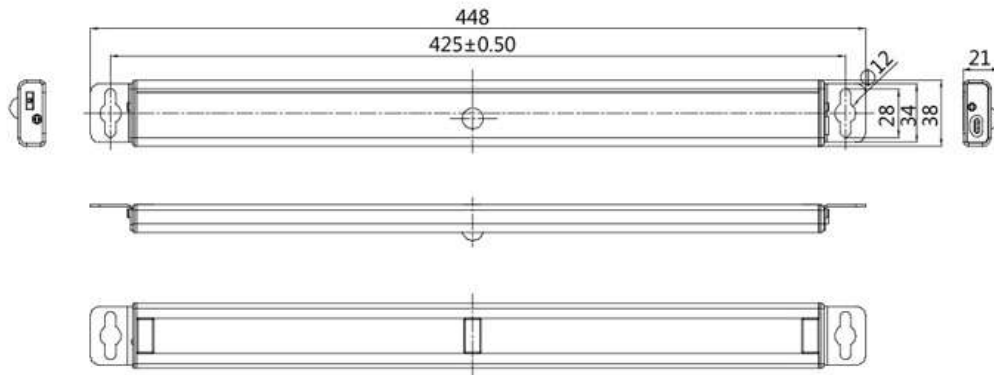

Drawings for products:

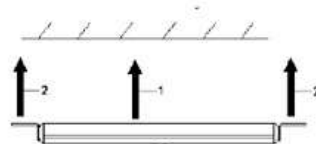
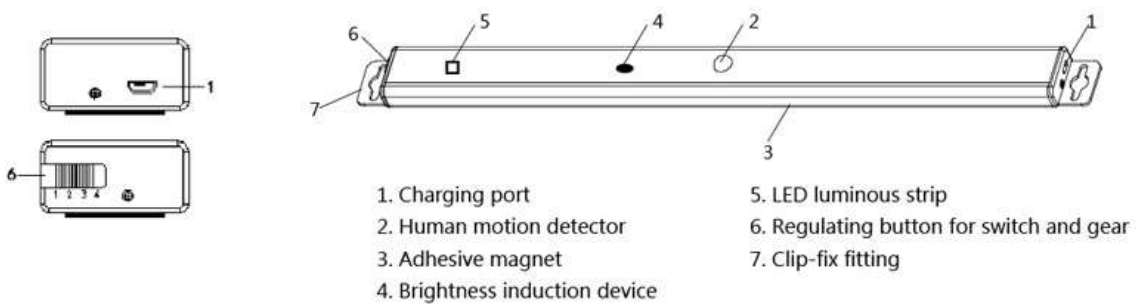

Mounting instruction:  
 1. Magnetic fixing  
 2. Screw mounting

Warnings

Don't install the light in the area with moisture , high temperature or venting air to ensure the normal use.  
 Charging timely once the light dimming to ensure the normal use of the lithium battery.  
 Don't charge more than six hours.



# LK 025 Energy-saving light



- Wide voltage range
- Integrated power unit
- Long-lived, maintenance-free
- Energy-saving by LED technology
- Daisy chain
- Magnet or screw fixing
- Quick connection

The lamp series LK 025 is suitable for all types of panels and enclosures, especially where space is at a premium. The lamps have a very long service life thanks to the use of LED technology. They are available with powerful non-slip rubberized magnets allowing them to be quickly positioned in any steel enclosure. Alternatively they can be fixed mechanically. The power output allows up to 10 lamps to be connected to each other (daisy chain). Both the power input and output connectors snap lock into their sockets. With the integrated power unit and the plugs the lamp can quickly be connected.

## Technical Drawing

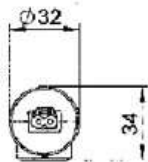

Side view  
magnet fixing

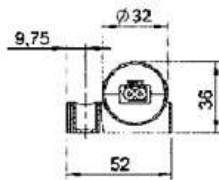

Side view  
screw fixing



## Technical Data

Power consumption	max. 5W
Luminosity	290Lm at 120°C (870Lm at 360°C or equivalent 75W light bulb)
Lamp type	LED, angle of radiation 120°
	Light color: daylight, color temperature: 6,500K
Service life	60,000h at 20°C (68°F)
	2-pole connector with snap lock
Connection	AC: max. 2.5A / 240VAC, color: white
	DC: max. 2.5A / 60VDC, color: blue
Mounting	magnet fixing or
	screw fixing, M5, 250mm centers
Casing	plastic, transparent
Dimensions	351 x 34 x 32mm (with magnet fixing)
	351 x 36 x 32mm (with screw fixing)
Operating / Storage temperature	-30 to +60°C (-22 to +140°F) / -40 to +85°C (-40 to +185°F)
Operating / Storage humidity	max. 90% RH (non-condensing)
Protection type / Protection class	IP20 / II (double insulated)

Art. No. magnet fixing	Art. No. Screw fixing	Operating voltage	Switch	Weight (approx.)
02540.0-00	02540.0-01	100-240VAC, 50/60Hz (min. 90VAC, max. 265VAC)	on/off light switch	0.2kg
02540.1-00	02540.1-01	24-48VDC (min. 20VDC, max. 60VDC)	on/off light switch	0.2kg



### Application

LKL10-W Series LED light is designed for instrument cabinet illumination of various switchgear.

### Features and advantage

- ◆ Economize on energy, In the case of Illuminate effect same alike the traditional light, economizing on energy is 75% above.
- ◆ Life span is long, the LED light source, someone call it the longevity light, meaning to extinguish never. It's the solid cold light source, adopt a special electric circuit design, the life span can reach to for 100,000 hours, comparing traditional light source life span to grow 1000% above.
- ◆ The environmental protection performance is better, without ultraviolet ray and infrared rays in the spectrum, without calories and radiate, the dizzy light is small, and the castoff can recover, without pollution and do not contain the mercury chemical Element. The cold light source, can be touched, belong to typical model of the green illuminate light source.
- ◆ Special circuit design, if anyone LED is bad, it isn't without influence to normal lumination of others LED.
- ◆ Special structure design, light body position can be adjusted, that solves the problem of less lumination angle of LED.
- ◆ The power supply adapt to AC/DC110~230V,suitable in application case of switchgear especially .
- ◆ With two mounting methods of clamp and fixation.

### Technique parameters

Enclosure material	PC-ABS(halogen-free)
Protection category	IP 20
Power supply	AC(50/60Hz)/DC 110V~230V
Wire connection	1×4mm <sup>2</sup> or 2×1.5mm <sup>2</sup>
Insulating strength	AC2500V, 1Min
luminescence component	LED
Ambient temperature	-25℃~50℃
Relative humidity	25% ~ 95%
Life span	More than 100,000hours

# LKL10-W / LKL10-W-3 Series

## Models explanation

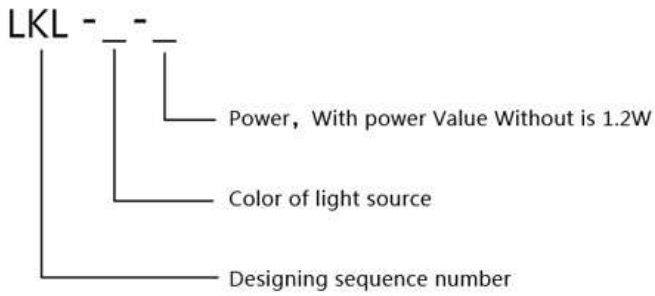

TYPE	LKL10-W	LKL10-W-3
Color of light source	White	Black
Power	1.2W	3W

## Dimension diagram

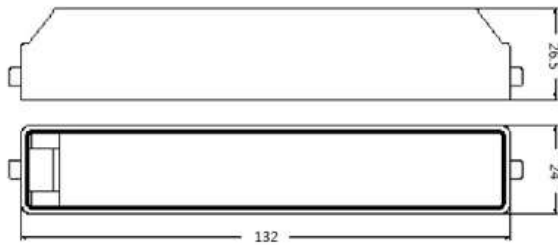

Dimension of LKL10-W light body

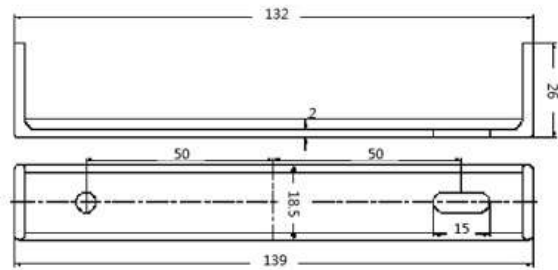

Dimension of LKL10-W light bracket

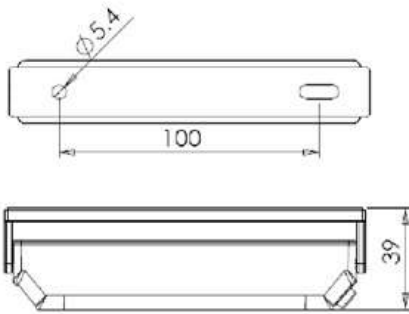

Dimension of LKL10-W-3 light body

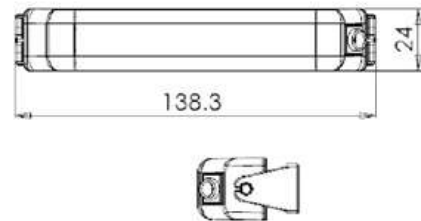

Dimension of LKL10-W-3 light bracket

## Installation

Assemble by clamp or bolt fixation. Assemble bracket first, then connect the power cable into light body terminal, insert the terminal side of light body into assemble hole of bracket, another side insert into the another side of bracket with screwdriver.

The angle between the support and the light body can be adjust according to the lumination need.

LKL10-W Light body



LKL10-W Bracket



LKL10-W assembled





### Application

The LKCL 20-W is the substitute of the traditional cable cabinet lamp, adopt LED as light source, and adopt metal shell, carry out low cost and high reliability and use easily .

### Features and advantages

- ◆ Choose the LED that suitable with the cable cabinet illuminance, ensure illuminance effect with lower power consumption
- ◆ Since LED life is long, replacing is not be acted as normal situation.
- ◆ The material of shell adopt metal.

### Models explanation

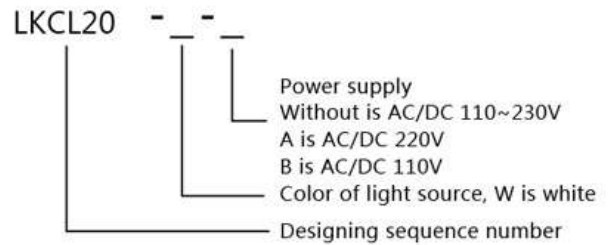

Rated power voltage	AC(50/60Hz)/DC110V~230V / AC(50/60Hz)/DC220V / AC(50/60Hz)/DC110V
Power Consumption	< 4W
Illuminance	Center point 30cm from lamp, >350Lx
Life span	Use highlight LED, the life span is no less Than for 50000 hours
Arc accident shock strength	>10000N
Insulating strength	AC2500V,1Min
Ambient temperature	-25℃~50℃
Relative humidity	25% ~ 95%
Mount method	Fix

TYPE	LKCL 20-W	LKCL 20-W-A	LKCL 20-W-B
Color of light source	White	White	White
Power supply	AC/DC 110~230V	AC/DC 240V	AC/DC 110V

### Dimension diagram

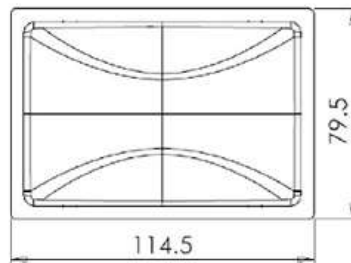
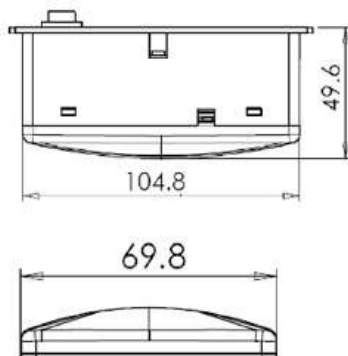

Cut-out dimension  
107×71

Terminal Cross Section

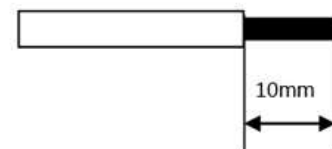

Nominal Cross Section:2.5mm<sup>2</sup>

## T5 Fluorescent Cabinet Lamp



- High brightness, small size, with on/off switch
- High lighting effect, save 55% power
- Long life non flicker and can start by low voltage
- T5 Fluorescent with Opal Cover, Or with Striate Cover

Model	Name	voltage	Power	PF	Dimension	Color temperature	QTY/CTN
LK-Y5Z04/YW01	T5 Aluminum Profile Fluorescent	220V/50HZ	4W	0.55	156x24x36	2700K/6500K	30
LK-Y5Z06/YW01			6W		255x24x36	2700K/6500K	30
LK-Y5Z08/YW01			8W		309x24x36	2700K/6500K	30
LK-Y5Z12/YW01			12W		486x24x36	2700K/6500K	30
LK-Y5Z14/YW01			14W	571x24x36	2700K/6500K	30	
LK-Y5Z18/YW01			18W	731x24x36	0.95	2700K/6500K	30
LK-Y5Z21/YW01			21W	871x24x36	2700K/6500K	30	

## T5 LED Cabinet Lamp



- The LED Lighting has no strobe, no infrared and ultraviolet, radiation free., Mercury free protect the natural environment
- High-quality LED chips as the illuminant, save more power, LED chip is antistatic.
- LED chips are solid encapsulation, they belong to cold light type, impact resistance, shockproof., easy for installation.
- Start fast, Long life: operation life about 50 thousand hours.

Model	LED Qty	Input voltage	Power	Luminous flux	Life (H)	Ra	External dimension	Color temperature	Qty
LK-L5X10A	96	AC110-240V	10W	870	>50000	≥80	850mm	3000/6400	30
LK-L5X10A	102	AC110-240V	10W	890	>50000	≥80	871mm	3000/6400	30
LK-L5X9A	80	AC110-240V	9W	700	>50000	≥80	731mm	3000/6400	30
LK-L5X6A	60	AC110-240V	6W	530	>50000	≥80	550mm	3000/6400	30
LK-L5X6A	64	AC110-240V	6W	560	>50000	≥80	571mm	3000/6400	30
LK-L5X5A	52	AC110-240V	5W	450	>50000	≥80	486mm	3000/6400	30
LK-L5X4A	38	AC110-240V	4W	330	>50000	≥80	309mm	3000/6400	30

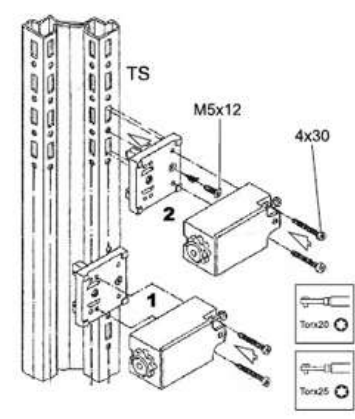
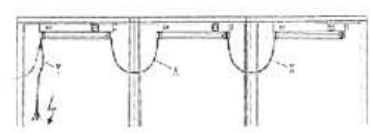
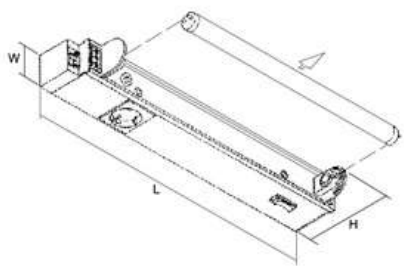
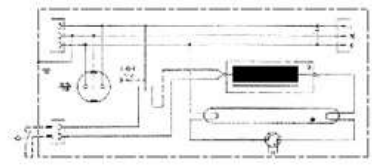
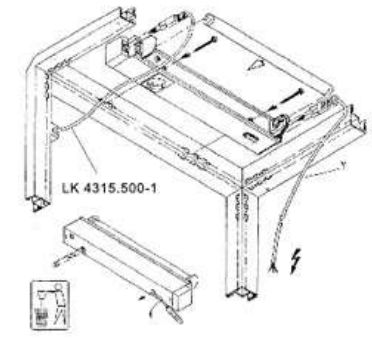

	Type	Type
	<b>LK-4138.10-1</b>	<b>LK-4138.18-1</b>
L mm	425	685
W mm	50	50
H mm	117	117
Pw	10w	18w

X	Y
LK4315.200-1	LK4315.100-1
LK4315.400-1	
LK4315.600-1	

## Lamp Cable



Door-Control Switch



Connection Cable



Power Cable

Type	LK4315.500-1
Cable length(mm)	500
Colour	White

Type	LK4315.200-1	LK4315.600-1	LK4315.4000-1
Cable length(mm)	1000	600	4000
Colour	Orange	Orange	Orange

Type	LK4315.100-3	LK4315.100-2	LK4315.100-1
Cable length(mm)	3000	2000	1000
Colour	Orange	Orange	Orange

# MR10L-100 Series Residual Current Circuit Breaker



## Product function and the application

MR10L-100 electromagnetic type residual current circuit breaker(RCCB operating function independent of line voltage)applies to the electrical circuit which alternating current 50/60Hz, rated voltage 230V (1P+N),400V(3P+N),rated current 100A. When human get an electric shock or electric leakage current exceeds specified value, residual current circuit breaker can switch off fault power source within 0.1S (1\* $\Delta n$ ) quickly, protects human body and electric equipment safety, also can be used to switch on and switch off circuit infrequently.

### Application field:

RCCB applies to industry, commerce, residential houses and similar places and so on...

Product standard of according with: GB16916.1,GB16916.21 & IEC61008-1,IEC61008-2-1

### Product feature:

- Operating mechanism is plastic structure,operating performance is more stable and reliable than metal structure;
- Inside all current-carrying parts material:1.5 thick pure copper;
- Shell frame current level:100A, Rated conditional short-circuit current up to  $I_{nc}=100000A$ .

### Technical data

Rated Voltage $U_n$ (V)
Rated Current $I_n$ (A)
Rated residual operating current $I_{\Delta n}$ (A)
Rated residual non-operating current $I_{\Delta no}$
The number of pole
According to the working condition of DC component or not
Time-delay type
Rated conditional short-circuit current $I_{nc}(A)$
Rated conditional residual short-circuit current $I_{\Delta c}(A)$
Rated making and breaking capacity $I_m(A)$
Rated residual making and breaking capacity $I_{\Delta m}(A)$
Electric-mechanical endurance
Tightening torque (N.m)
Pollution level
Protection level
Installation category

### Data

230~1P+N,400~3P+N
16,20,25,32,40,50,63,80,100
0.03,0.1,0.3
0.5 $I_{\Delta n}$
1P+N, 3P+N
AC type, A type
S type
4500, 6000, 10000 ( $I_{nc}$ can be chosen by customers)
4500, 6000, 10000 ( $I_{\Delta c}$ can be chosen by customers)
500( $I_n \leq 50A$ ), 630 ( $I_n = 63A$ ), 800( $I_n = 80A$ ),100( $I_n = 100A$ )
500( $I_n \leq 50A$ ), 630 ( $I_n = 63A$ ), 800( $I_n = 80A$ ),100( $I_n = 100A$ )
Mechanical endurance $\geq 4000$ cycle, Electro endurance $\geq 2000$ cycle
2.5~4
Level 2
IP20
II type

### Overall & installation dimensions

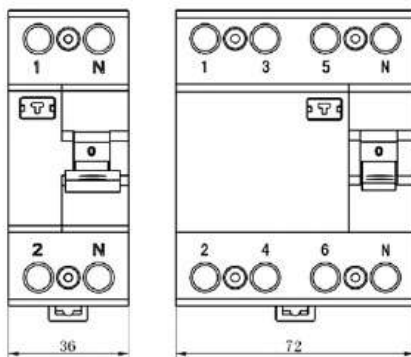

Front view

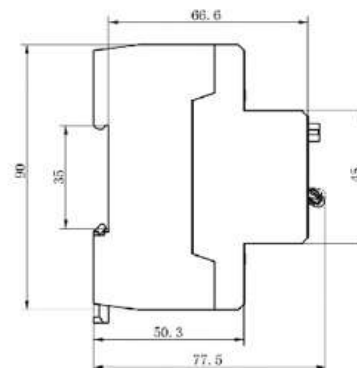

Side view



### Product function and the application

MR20L-63 electromagnetic type residual current circuit breaker(RCCB operating function independent of line voltage)applies to the electrical circuit which alternating current 50/60Hz, rated voltage 230V (1P+N),400V(3P+N),rated current 63A. When human get an electric shock or electric leakage current exceeds specified value, residual current circuit breaker can switch off fault power source within 0.1S ( $1 \cdot I_{\Delta n}$ ) quickly, protects human body and electric equipment safety, also can be used to switch on and switch off circuit infrequently.

#### Application field:

RCCB applies to industry, commerce, residential houses and similar places and so on...

Product standard of according with: GB16916.1,GB16916.21 & IEC61008-1,IEC61008-2-1

#### Product feature:

- ☑ Operating mechanism is plastic structure,operating performance is more stable and reliable than metal structure;
- ☑ Inside all current-carrying parts material: copper;
- ☑ Shell frame current level:63A, Rated conditional short-circuit current up to  $I_{nc}=6000A$ .

#### Technical data

Rated Voltage $U_n$ (V)
Rated Current $I_n$ (A)
Rated residual operating current $I_{\Delta n}$ (A)
Rated residual non-operating current $I_{\Delta no}$
The number of pole
According to the working condition of DC component or not
Time-delay type
Rated conditional short-circuit current $I_{nc}(A)$
Rated conditional residual short-circuit current $I_{\Delta c}(A)$
Rated making and breaking capacity $I_m(A)$
Rated residual making and breaking capacity $I_{\Delta m}(A)$
Electric-mechanical endurance
Tightening torque (N.m)
Pollution level
Protection level
Installation category

#### Data

230~1P+N,400~3P+N
16,20,25,32,40,50,63
0.03,0.1,0.3
$0.5I_{\Delta n}$
1P+N, 3P+N
AC type, A type
S type
4500, 6000 ( $I_{nc}$ can be chosen by customers)
4500, 6000 ( $I_{\Delta c}$ can be chosen by customers)
500( $I_n \leq 50A$ ), 630 ( $I_n = 63A$ )
500( $I_n \leq 50A$ ), 630 ( $I_n = 63A$ )
Mechanical endurance $\geq 4000$ cycle, Electro endurance $\geq 2000$ cycle
2.5~4
Level 2
IP20
II type

#### Overall & installation dimensions

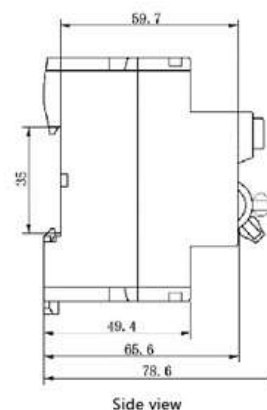
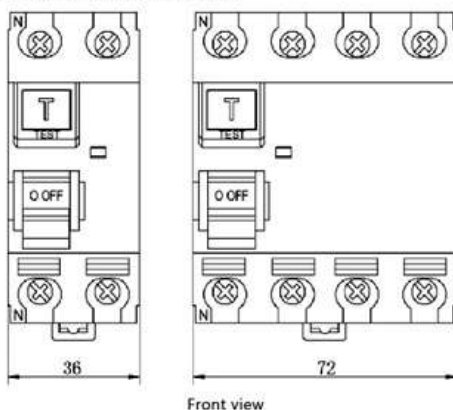



### Features

- ◆ Economic thermoplastic
- ◆ Stainless steel roller, punch, and Spring
- ◆ Max. ±95° rotary lever
- ◆ Cable gland size M20\*1.5

### Contact configurations

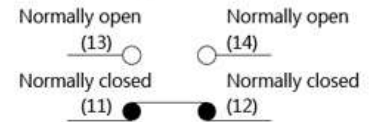

### Dimensions:

PLS-131 (Thermoplastic roller available)

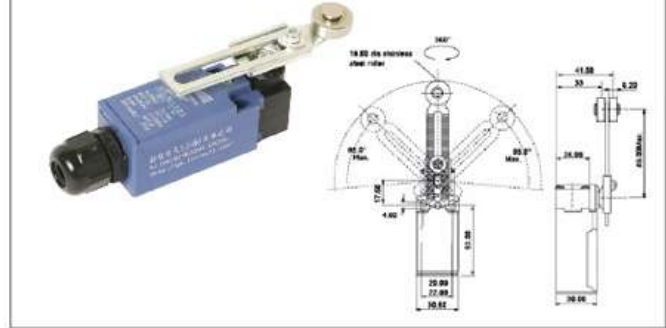

PLS-103

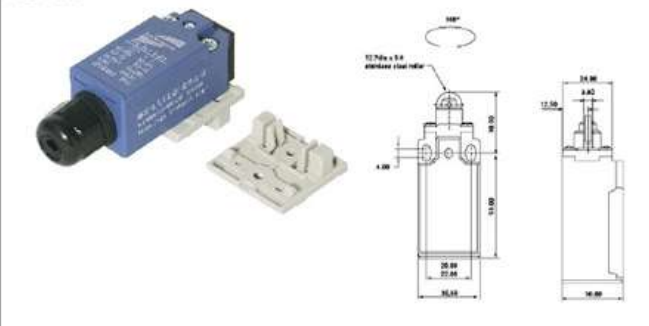

PLS-101

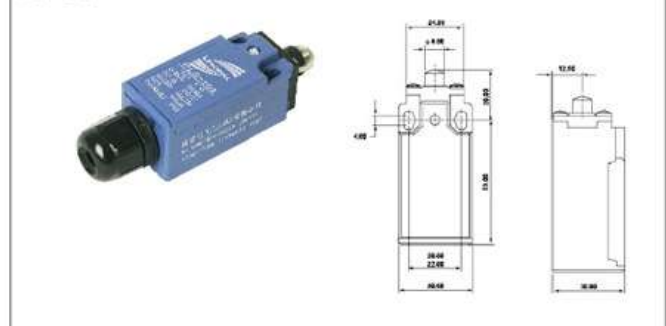

### Ratings

Rated voltage	Non-inductive load (A)				Inductive load (A)			
	Resistive load		Lamp load		Inductive load		Motor load	
	NC	NO	NC	NO	NC	NO	NC	NO
125VAC	5	5	1.5	0.7	3	3	2	1
250VAC	5	5	1	0.5	3	3	1.5	0.8
8VDC	5	5	3	3	5	4	3	3
14VDC	5	5	3	3	4	4	3	3
30VDC	5	5	3	3	4	4	3	3
125VDC	0.4	0.4						
250VDC	0.2	0.2						

Inrush current N.C.:24A max., N.O.:12A max.

- Note: 1. Inductive loads have a power factor of 0.4 min. (AC) and a time constant of 7 msec max. (DC).  
 2. Lamp loads have an inrush current of 10 times the steady-state current. Motor loads have an inrush current of 6 times the steady-state current.  
 3. For the products with spring, the operating range is limited to the part from the front of the spring to the 1/3 full length of the spring.

### Specification

Code	PLS	101 301	103 303	111 311	121 321	127 327	131 331	161 361	171 371	181 381	191 391
Operating force	OF(Max.)	700g	700g	700g	500g	700g	500g-cm	100g	100g	100g	500g-cm
Release force	RF(Min.)	200g	200g	200g	100g-cm	200g	100g-cm	40g	40g	40g	100g-cm
Pre-Travel	PT(Max.)	1.8mm	1.8mm	1.8mm	20°	1.8mm	20°	30mm	30mm	30mm	20°
Tripping position	TP±10%	2.0mm	2.0mm	2.0mm	22.5°	2.0mm	22.5°	22.5°	22.5°	22.5°	22.5°
Movement differential	MD(Max.)	1.2mm	1.2mm	1.2mm	10°	1.2mm	10°	14°	14°	14°	10°
After travel	OT(Min.)	4.0mm	4.0mm	4.0mm	75°	4.0mm	75°	20mm	20mm	20mm	75°
Total travel	TT(Min.)	5.8mm	5.8mm	5.8mm	95°	5.8mm	95°	50mm	50mm	50mm	95°
Angle of rotary lever					22.5°		22.5°				22.5°

### Characteristics

Operating speed	0.1 mm/s to 50cm/s (in case of pin plunger)
Operating frequency	Mechanical: 120 operations/ min Electronic: 30 operations/ min
Contact Resistance	25mΩ (mm) ( Initial )
Insulation resistance	100mΩ Min. at 500VDC
Dielectric strength	1000VAC, 50/60Hz/ 1 min between terminals of same polarity
	1500VAC, 50/60Hz/ 1 min between current-carrying metal parts and ground 1500VAC, 50/60Hz/ 1 min between each terminal and non-current-carrying metal part
Vibration resistance	10-55 Hz, 1.5mm double amplitude
Shock resistance	Mechanical durability: 1,000m/Sec <sup>2</sup> (approx.100G S) False action durability: 300m/Sec <sup>2</sup> (approx.30G S)
Ambient operating temperature	Operating -10 ~+ 70C (no icing)
Ambient operating Humidity	95%RH Max
Service life	Mechanical > 10,000,000 operations, Electrical > 500,000 operations
Degree of protection	IP65 (IEC standard)

New BK Cable clamp series

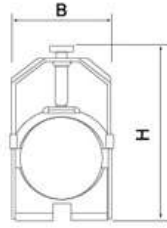
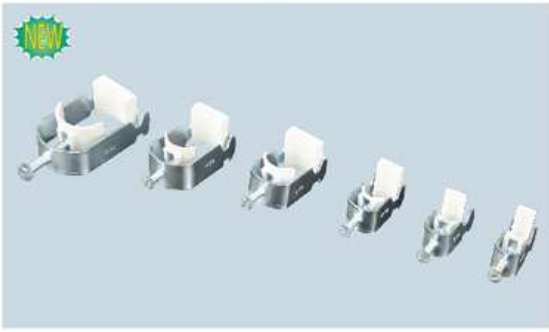

Material & Specification		Cable diameter φ (mm)	Size(mm)	
Galvanized steel	Stainless steel		B	H
BK14	BK14E	6-12	21	70
BK18	BK18 E	12-18	23	70
BK22	BK22 E	18-22	27	75
BK30	BK30 E	22-30	39	85
BK38	BK38 E	30-38	45	90
BK42	BK42E	38-42	47	95
BK50	BK50E	42-50	57	120
BK64	BK64 E	50-64	70	130
BK70	BK70 E	64-72	77	165
BK80	BK80 E	72-82	87	183
BK100	BK100 E	95-102	108	217

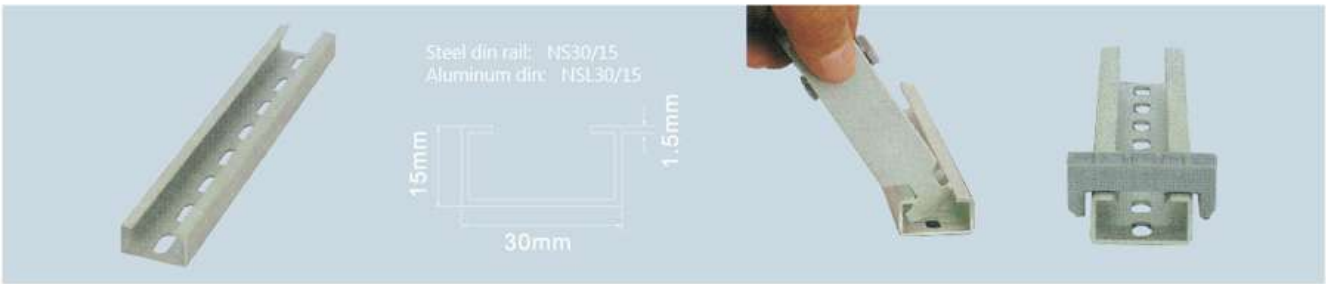

Cable entry sleeve

It could tightly clutch different cable on the bottom of the case. It is used together with a cable leading bar.

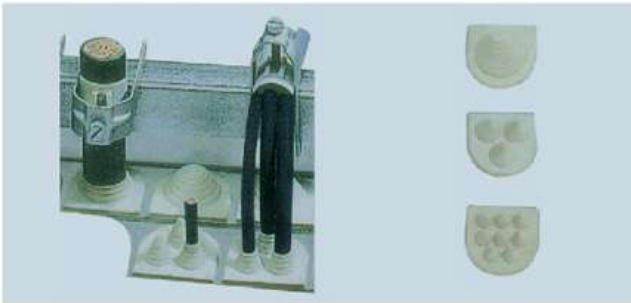

Model	Diameter mm	Cable Number
US1	47	1
US3	21	3
US8	13	8

Fix the cable on the cable clamp orbit by plastic pad.



UZ6-12~UZ46-50

Model	UZ6-12	UZ12-16	UZ14-18	UZ18-22	UZ22-26	UZ26-30
Diameter mm	6-12	12-16	14-18	18-22	22-26	26-30
Model	UZ30-34	UZ34-38	UZ38-42	UZ42-46	UZ46-50	
Diameter mm	30-34	34-38	38-42	42-46	46-50	



Adhesive tape for panel IF001-16x3 / 5 / 7

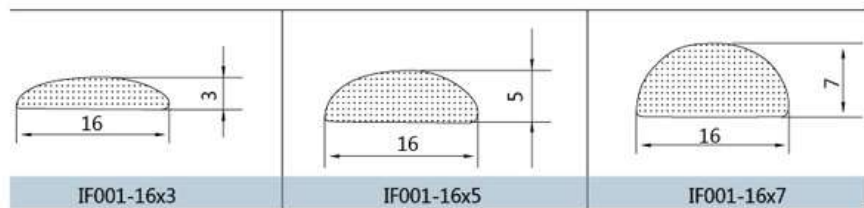

## LK-705

Sealed enclosures when subject to external temperature fluctuations develop pressure differential toward the ambient. As a consequence entrance of dust and/or humidity is likely to happen through leakage points. Installing a LK-705 prevents this risk while preserving a high protection degree for the enclosure.

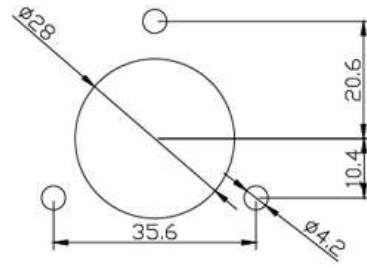

Features	unit	Characters
Material	-	ABS self-extinguishing
Color	-	Grey(RAL7035), Black(RAL9005)
Protection degree	-	IP54
Fixing	-	Screws with rubber gasket
Dimensions HxWxD	mm	70x50x21
Weight	kg	0.03

## Documents Pocket WJ-1

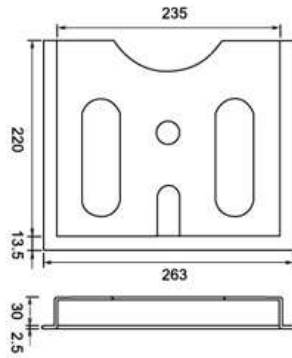

Plastic Documents Pockets  
For affixing to the inside surfaces of panel doors

Material :  
plastic ABS with self-adhesive fastening strips  
3M adhesive tape

Installation:  
Screw mounting or adhesive tape mounting

Colour:  
Similar to RAL7035

Cabinet Accessories

## Documents Pocket WJ-2

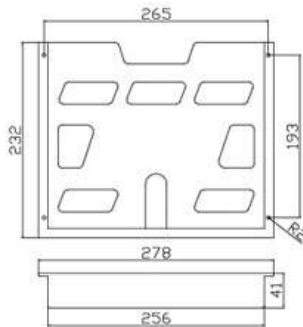

## Documents Pocket WJ-3

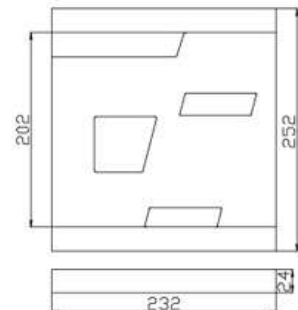

## Documents Pocket WJ-4

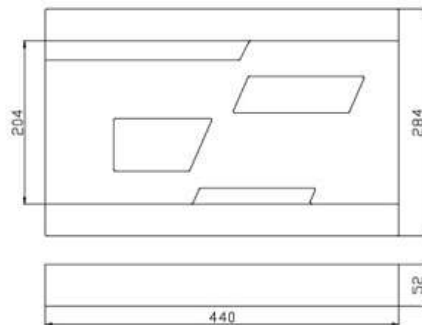

## Product back

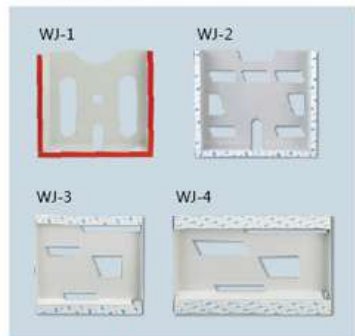



# Cable Glands Series

# Nylon Cable Glands (Standard type)

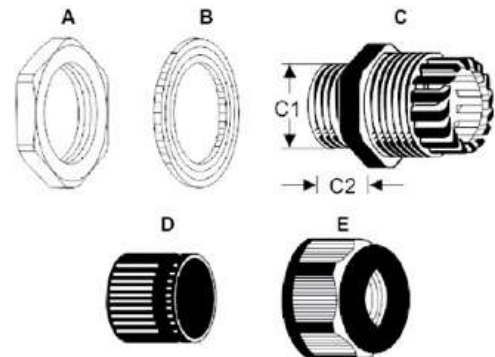

## Product Overview

- ◆ Thread: PG, Metric, G, and NPT thread
- ◆ Materials: UL approved Nylon PA66 (Flammability) UL 94V-2) for A. C. E parts, (Accept to make flammability UL 94V-0); EPDM rubber for B. D parts, (Also accept to make super rubber: resist high temperature rubber, resist strong acid/alkali, etc).
- ◆ Protection degree: IP68
- ◆ Working temperature: -40°C to 100°C
- ◆ Features: The claws and seals of excellent design, sealing nut have a "click" sound and re-open, can hold cable firmly and have a wider cable range. Resistant to salt water, weak acid, alcohol, oil, grease and common solvency.
- ◆ Colours: Black(RAL9005), gray(RAL7035), other color available upon request.

PG Type	PG Thicken Type	Applicable to cable	Thread diameter C1	Thread length C2	Wrench diameter
PG7	PG7-T	3~6.5	12.5	8	16
PG9	PG9-T	4~8	15.2	8	19
PG11	PG11-T	5~10	18.6	8	22
PG13.5	PG13.5-T	6~12	20.4	10	24
PG16	PG16-T	10~14	22.5	10	27
PG19	PG19-T	12~16	24	10	27
PG21	PG21-T	13~18	28.3	10	33
PG25	PG25-T	16~21	30	11	35
PG29	PG29-T	18~25	37	12	42
PG36	PG36-T	22~32	47	14	52
PG42	PG42-T	32~38	54	14	60
PG48	PG48-T	37~44	59.3	15	64
PG63	PG63-T	42~50	71	28	77

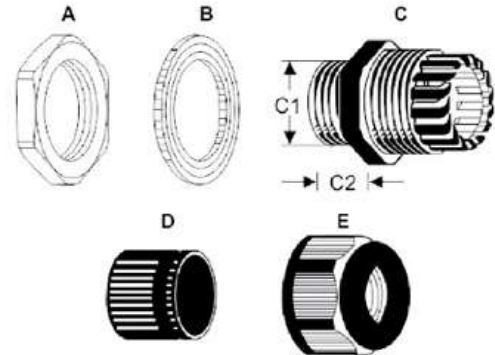

## Product Overview

- ◆ Thread: Metric, PG, G(PF), and NPT thread
- ◆ Materials: UL approved Nylon PA66 (Flammability) UL 94V-2) for A. C. E parts, (Accept to make flammability UL 94V-0); EPDM rubber for B. D parts, (Also accept to make super rubber: resist high temperature rubber, resist strong acid/alkali, etc).
- ◆ Protection degree: IP68
- ◆ Working temperature: -40°C to 100°C
- ◆ Features: The claws and seals of excellent design, sealing nut have a "click" sound and re-open, can hold cable firmly and have a wider cable range. Resistant to salt water, weak acid, alcohol, oil, grease and common solvency.
- ◆ Colours: Black(RAL9005), gray(RAL7035), other color available upon request.

PG Type	PG Thicken Type	Applicable to cable	Thread diameter C1	Thread length C2	Wrench diameter
M12x1.5	M12x1.5-T	3~6.5	12	8	16
M16x1.5	M16x1.5-T	4~8	16	8	19
M18x1.5	M18x1.5-T	5~10	18	8	22
M20x1.5	M20x1.5-T	6~12	20	10	24
M22x1.5	M22x1.5-T	10~14	22	10	27
M24x1.5	M24x1.5-T	12~16	24	10	27
M25x1.5	M25x1.5-T	13~18	25	10	33
M27x1.5	M27x1.5-T	13~18	27	10	33
M30x1.5	M30x1.5-T	16~21	30	11	35
M32x1.5	M32x1.5-T	16~21	32	11	35
M36x1.5	M36x1.5-T	18~25	36	12	42
M40x1.5	M40x1.5-T	22~32	40	14	52
M50x1.5	M50x1.5-T	32~38	50	14	60
M63x1.5	M63x1.5-T	37~44	63	15	64
M71x1.5	M71x1.5-T	42~50	71	28	77

# Waterproof joint(double-end connector)



Executive standard: IEC60529 IP68  
EN 60309

Colors available: grey/black

Applications:

For outdoor cable connections where require the waterproof function, such as street lamps, bridge and tunnel lights, garden illumination, large electronic displays, etc.

## PG11



cable diameter  $\Phi$  5-10mm

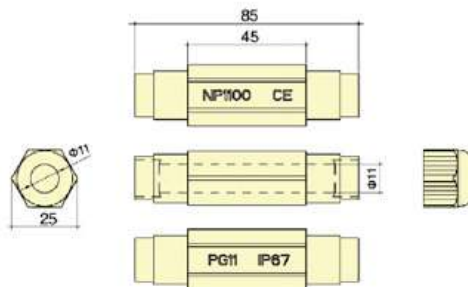

Specifications mm <sup>2</sup>	external diameter mm
2x0.2	4.2
2x0.3	5.0
2x0.5	5.8
2x0.75	6.0
2x1	6.8
2x1.5	7.8
2x2.5	9.6
2x4	11.5
2x6	13

## PG13.5



cable diameter  $\Phi$  6-12mm

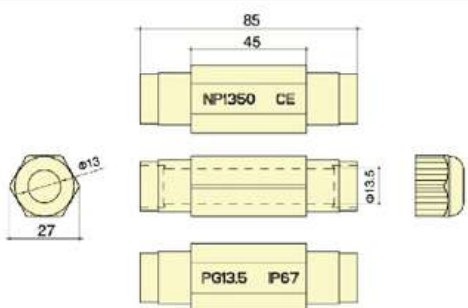

Specifications mm <sup>2</sup>	external diameter mm
3x0.2	4.4
3x0.3	5.3
3x0.5	6.2
3x0.75	6.4
3x1	7.15
3x1.5	8.45
3x2.5	10.4
3x4	12.3
3x6	13.5



### Product Overview

- ◆ Material: Nylon PA66
- ◆ Protection degree: IP68
- ◆ Working temperature: -40°C to 100°C
- ◆ Application: Dust-proof for spare holes
- ◆ Colours: Black and gray

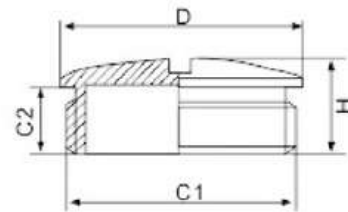

## Nylon Screw Plugs PG Type

PG Type	Thread diameter C1	Thread length C2	Main Dimensions H	Cover Dimensions D
PG7	12.5	8.5	12.5	15
PG9	15.2	8.5	13	19
PG11	18.6	9	13	22
PG13.5	20.4	9	13	25
PG16	22.5	10.5	15	27
PG21	28.3	10.5	15.5	33
PG29	37	11.5	16	44
PG36	47	13.5	18	55
PG42	54	13.5	18.5	62
PG48	59.3	14.5	19.5	68

## Nylon Screw Plugs M Type

M Type	Thread diameter C1	Thread length C2	Main Dimensions H	Cover Dimensions D
M12x1.5	12	8.5	12.5	15
M16x1.5	16	8.5	13	19
M18x1.5	18	9	13	22
M20x1.5	20	9	13	25
M22x1.5	22	10.5	15	27
M25x1.5	25	10.5	15.5	30
M27x1.5	27	10.5	15.5	33
M32x1.5	32	10.5	16	38
M40x1.5	40	11.5	16	46
M50x1.5	50	13.5	18	56
M63x1.5	63	14.5	19	68

# Spiral Cable Glands (PG/M type)



## Product Overview

- ◆ Thread: PG, Metric, G, and NPT thread
- ◆ Materials: UL approved Nylon PA66 (Flammability UL 94V-2) for A. C. E parts, (Accept to make flammability UL 94V-0); EPDM rubber for B. D parts, (Also accept to make super rubber: resist high temperature rubber, resist strong acid/alkali, etc).
- ◆ Protection degree: IP68
- ◆ Working temperature: -40°C to 100°C
- ◆ Features: The claws and seals of excellent design, sealing nut have a "click" sound and re-open, can hold cable firmly and have a wider cable range. Resistant to salt water, weak acid, alcohol, oil, grease and common solvency.
- ◆ Colours: Black(RAL9005), gray(RAL7035), other color available upon request.

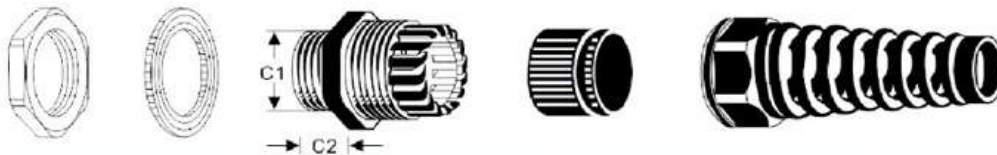

## Spiral Cable Glands PG type

PG Type	Cable Range	Thread diameter C1	Thread length C2	Wrench diameter
PG7	3~6.5	12.5	8	16
PG7	2~5	12.5	8	16
PG9	4~8	15.2	8	19
PG9	2~6	15.2	8	19
PG11	5~10	18.6	8	22
PG11	3~7	18.6	8	22
PG13.5	6~12	20.4	9	24
PG13.5	5~9	20.4	9	24
PG16	10~14	22.5	10	27
PG16	7~12	22.5	10	27
PG21	13~18	28.3	10	33
PG21	9~16	28.3	10	33

## Spiral Cable Glands M type

M Type	Cable Range	Thread diameter C1	Thread length C2	Wrench diameter
M12x1.5	3~6.5	12	8	16
M12x1.5	2~5	12	8	16
M16x1.5	4~8	16	8	19
M16x1.5	2~6	16	8	19
M18x1.5	5~10	18	8	22
M18x1.5	3~7	18	8	22
M20x1.5	6~12	20	9	24
M20x1.5	5~9	20	9	24
M22x1.5	10~14	22	10	27
M22x1.5	7~12	22	10	27
M25x1.5	13~18	25	10	33
M25x1.5	9~16	25	10	33
M27x1.5	13~18	27	10	33
M27x1.5	9~16	27	10	33



Material: Parts A, C, F are made of brass plated with nickel, part D is made of UL approved nylon PA66, parts B and E are made of nitrile butadiene rubber (NBR).

Thread spec.: Metric, PG, G, NPT.

Working temperature: -40 °C to 100 °C, instantaneous heat resistance up to 120 °C.

Characteristics: Special design of clamping die and rubber part, large range in clamping the cable, ultrastrong stretching resistance, waterproof, dustproof, and high ability to resist salt, acid, alkali, alcohol, grease and general solvent.

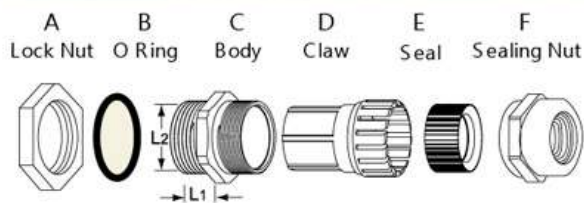

Model	Thread Size	Cable Range (mm)	Thread O. D. L2 (mm)	Thread Length L1 (mm)	Spanner Size (mm)
PG7-M	PG7	3~6.5	12.5	5	14
PG7-M	PG7	2~5	12.5	5	14
PG9-M	PG9	5~9	15.2	6	17
PG9-M	PG9	2~6	15.2	6	17
PG11-M	PG11	6.5~11	18.6	6	20
PG11-M	PG11	3~7	18.6	6	20
PG13.5-M	PG13.5	7~13	20.4	6.5	22
PG13.5-M	PG13.5	5~9	20.4	6.5	22
PG16-M	PG16	9~14	22.5	6.5	24
PG16-M	PG16	6~12	22.5	6.5	24
PG21-M	PG21	11~18	28.3	7	30
PG21-M	PG21	9~16	28.3	7	30
PG29-M	PG29	18~26	37	8	40
PG29-M	PG29	13~20	37	8	40
PG36-M	PG36	24~33	47	9	50
PG36-M	PG36	20~26	47	9	50
PG42-M	PG42	30~39	54	10	58
PG42-M	PG42	25~31	54	10	58
PG48-M	PG48	34~45	59.3	10	64
PG48-M	PG48	29~35	59.3	10	64

# Metallic cable gland PG-LM/M-M type



## Metallic cable gland PG-LM type

Model	Thread Size	Cable Range (mm)	Thread O. D. L2 (mm)	Thread Length L1 (mm)	Spanner Size (mm)
PG7-LM	PG7	3~6.5	12.5	6	14
PG7-LM	PG7	2~5	12.5	6	14
PG9-LM	PG9	4~8	15.2	7	17
PG9-LM	PG9	6~10	15.2	7	17
PG11-LM	PG11	6.5~11	18.6	7	20
PG11-LM	PG11	3~7	18.6	7	20
PG13.5-LM	PG13.5	6~12	20.4	8	22
PG13.5-LM	PG13.5	5~9	20.4	8	22
PG16-LM	PG16	10~14	22.5	8	24
PG16-LM	PG16	6~12	22.5	8	24
PG21-LM	PG21	11~18	28.3	8	30
PG21-LM	PG21	9~16	28.3	8	30
PG29-LM	PG29	18~26	37	9	40
PG29-LM	PG29	13~20	37	9	40
PG36-LM	PG36	25~32	47	10	50
PG36-LM	PG36	20~26	47	10	50
PG42-LM	PG42	32~38	54	10	58
PG42-LM	PG42	25~31	54	10	58
PG48-LM	PG48	34~45	59.3	12	64
PG48-LM	PG48	37~44	59.3	12	64

## Metallic cable gland M-M type

Model	Thread Size	Cable Range (mm)	Thread O. D. L2 (mm)	Thread Length L1 (mm)	Spanner Size (mm)
M12-M	M12x1.5	3~6.5	12	5	14
M14-M	M14x1.5	3~6.5	14	6	17
M16-M	M16x1.5	4~8	16	6	17
M18-M	M18x1.5	6~10	18	6	20
M20-M	M20x1.5	8~12	20	6	22
M22-M	M22x1.5	10~14	22	6	24
M24-M	M24x1.5	9~14	24	7	30
M25-M	M25x1.5	9~14	25	7	30
M27-M	M27x1.5(2)	11~18	27	7	30
M30-M	M30x1.5(2)	11~18	30	7	37
M32-M	M32x1.5(2)	15~22	32	8	37
M33-M	M33x1.5(2)	15~22	33	8	37
M36-M	M36x1.5(2)	18~25	36	8	42
M40-M	M40x1.5(2)	18~25	40	8	46
M42-M	M42x1.5(2)	18~25	42	9	46
M48-M	M48x1.5(2)	25~32	48	9	52
M50-M	M50x1.5(2)	33~38	50	9	55
M54-M	M54x1.5(2)	30~38	54	12	58
M60-M	M60x1.5(2)	37~44	60	12	68
M63-M	M63x1.5(2)	37~44	63	12	68
M64-M	M64x1.5(2)	37~44	64	12	68



Material: Parts A, C, F are made of brass plated with nickel, part D is made of UL approved nylon PA66, parts B and E are made of nitrile butadiene rubber (NBR).

Thread spec.: Metric, PG, G, NPT.

Working temperature: -40°C to 100°C, instantaneous heat resistance up to 120°C.

Characteristics: Special design of clamping die and rubber part, large range in clamping the cable, ultrastrong stretching resistance, waterproof, dustproof, and high ability to resist salt, acid, alkali, alcohol, grease and general solvent.

A Lock Nut    B O Ring    C Body    D Claw    E Seal    F Sealing Nut

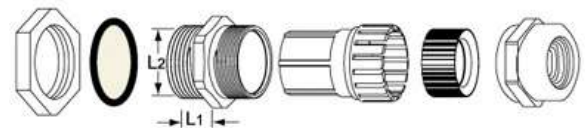

Model	Thread Size	Cable Range (mm)	Thread O. D. L2 (mm)	Thread Length L1 (mm)	Spanner Size (mm)
M12-LM	M12x1.5	3~6.5	12	6	14
M14-LM	M14x1.5	3~6.5	14	6	17
M16-LM	M16x1.5	4~8	16	7	17
M18-LM	M18x1.5	6~10	18	7	20
M20-LM	M20x1.5	8~12	20	8	22
M22-LM	M22x1.5	10~14	22	8	24
M24-LM	M24x1.5	10~14	24	8	27
M25-LM	M25x1.5	10~14	25	8	27
M27-LM	M27x1.5(2)	13~18	27	8	30
M30-LM	M30x1.5(2)	13~18	30	8	34
M32-LM	M32x1.5(2)	15~22	32	9	34
M33-LM	M33x1.5(2)	15~22	33	9	36
M36-LM	M36x1.5(2)	18~25	36	9	40
M40-LM	M40x1.5(2)	22~28	40	10	43
M42-LM	M42x1.5(2)	22~28	42	10	45
M48-LM	M48x1.5(2)	25~32	48	10	52
M50-LM	M50x1.5(2)	25~32	50	10	55
M54-LM	M54x1.5(2)	30~38	54	12	58
M60-LM	M60x1.5(2)	37~44	60	12	68
M63-LM	M63x1.5(2)	37~44	63	12	68
M64-LM	M64x1.5(2)	37~44	64	12	68

## Metallic cable gland NPT-M/PG-MA type



### Metallic cable gland NPT-M type

Model	Thread Size	Cable Range (mm)	Thread O. D. L2 (mm)	Thread Length L1 (mm)	Spanner Size (mm)
NPT3/8" -M	NPT3/8"	4~8	17.1	13	18
NPT3/8" -M	NPT3/8"	2~6	17.1	13	18
NPT1/2" -M	NPT1/2"	6~12	21.3	13	22
NPT1/2" -M	NPT1/2"	5~9	21.3	13	22
NPT3/4" -M	NPT3/4"	13~18	26.6	15	30
NPT3/4" -M	NPT3/4"	9~16	26.6	15	30
NPT1" -M	NPT1"	15~22	33.5	16	36
NPT1" -M	NPT1"	13~20	33.5	16	36
NPT1" -M	NPT1 1/4"	22~28	42	18	45
NPT1" -M	NPT1 1/4"	18~25	42	18	45
NPT1" -M	NPT1 1/2"	25~32	48	18	50
NPT1" -M	NPT1 1/2"	20~26	48	18	50

### Metallic cable gland PG-MA type

Model	Thread Size	Cable Range (mm)	Thread O. D. L2 (mm)	Thread Length L1 (mm)	Spanner Size (mm)
PG7-MA	PG7	3~6.5	12.5	6	14
PG7-MA	PG7	2~5	12.5	6	14
PG9-MA	PG9	4~8	15.2	7	17
PG9-MA	PG9	2~6	15.2	7	17
PG11-MA	PG11	5~10	18.6	7	20
PG11-MA	PG11	3~7	18.6	7	20
PG13.5-MA	PG13.5	6~12	20.4	7.5	22
PG13.5-MA	PG13.5	5~9	20.4	7.5	22
PG16-MA	PG16	10~14	22.5	7.5	24
PG16-MA	PG16	6~12	22.5	7.5	24
PG21-MA	PG21	13~18	28.3	8	30
PG21-MA	PG21	9~16	28.3	8	30
PG29-MA	PG29	18~25	37	9	40
PG29-MA	PG29	13~20	37	9	40
PG36-MA	PG36	25~32	47	9	50
PG36-MA	PG36	20~26	47	9	50
PG42-MA	PG42	32~38	54	10	58
PG42-MA	PG42	25~31	54	10	58
PG48-MA	PG48	37~44	59.3	11	64
PG48-MA	PG48	29~35	59.3	11	64

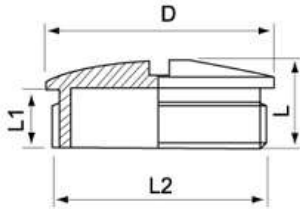

Material: Made of brass plated with nickel.

O-sealing element: Made of nitrile butadiene rubber (NBR).

Working temperature: -40°C to 100°C.

### Metallic threaded plug PG-TM type

Model	Thread Size	Thread O. D. L2 (mm)	Thread Length L1 (mm)	Main body Dimensions L (mm)	Cover Dimensions D (mm)
PG7-TM	PG7	12.5	5	8	14
PG9-TM	PG9	15.2	6	9	17
PG11-TM	PG11	18.6	6	9	20
PG13.5-TM	PG13.5	20.4	6.5	9.5	22
PG16-TM	PG16	22.5	6.5	9.5	24
PG21-TM	PG21	28.3	7	11	30
PG29-TM	PG29	37	8	12	40
PG36-TM	PG36	47	9	15	50
PG42-TM	PG42	54	10	16	60
PG48-TM	PG48	59.3	10	16	65

### Metallic threaded plug M-TM type

Model	Thread Size	Thread O. D. L2 (mm)	Thread Length L1 (mm)	Main body Dimensions L (mm)	Cover Dimensions D (mm)
M12-TM	M12x1.5	12	5	8	114
M16-TM	M16x1.5	16	6	9	18
M18-TM	M18x1.5	18	6	9	20
M20-TM	M20x1.5	20	6.5	9.5	22
M22-TM	M22x1.5	22	6.5	9.5	25
M25-TM	M25x1.5	25	7	11	28
M32-TM	M32x1.5	32	8	12	35
M40-TM	M40x1.5	40	9	15	44
M50-TM	M50x1.5	50	10	16	54
M63-TM	M63x1.5	63	10	16	67

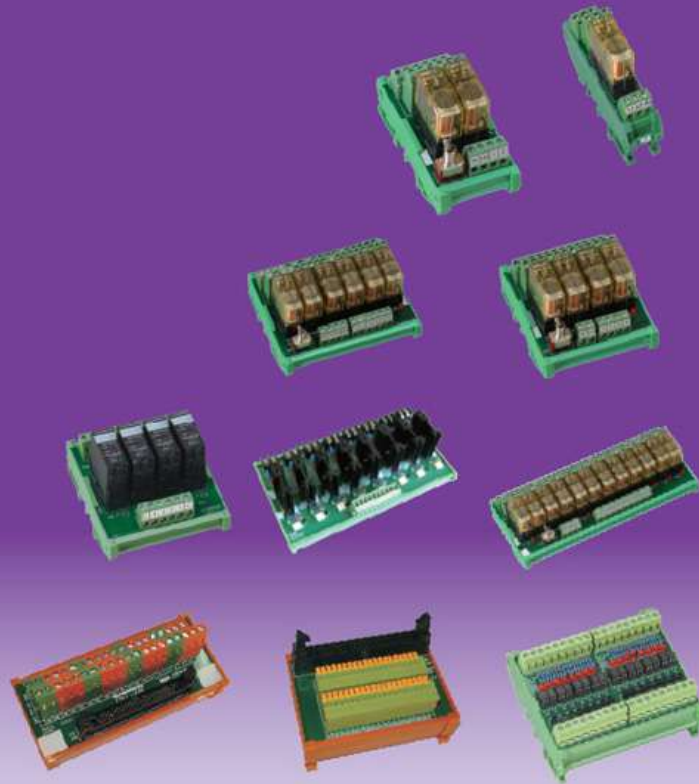

# Relay Module

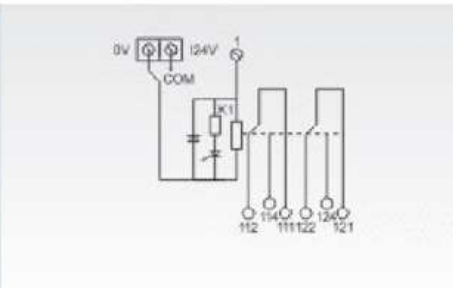
**LK-1-2Z-NP**
**■ Character**

Input type	Terminal block input, NPN and PNP is common
Relay	OMRON
Coil voltage	12,24,48,110,220VAC/DC
Relay quantity	1
Contact rating	250VAC/30VDC/8A 2Z
Outer dimension	15x85x66mm

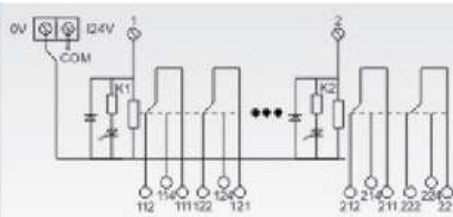
**LK-2-2Z-NP**
**■ Character**

Input type	Terminal block input, NPN and PNP is common; AC/DC is common
Relay	OMRON
Coil voltage	12,24,48,110,220VAC/DC
Relay quantity	2
Contact rating	250VAC/30VDC/8A 2Z
Outer dimension	15x85x66mm

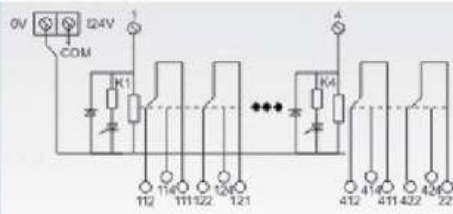

**LK-4-2Z-NP**
**■ Character**

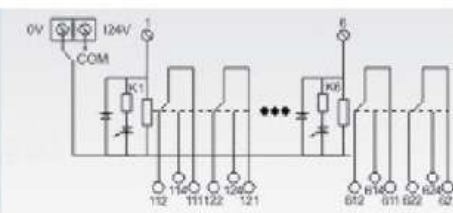
Input type	Terminal block input, NPN and PNP is common; AC/DC is common
Relay	OMRON
Coil voltage	12,24,48,110,220VAC/DC
Relay quantity	4
Contact rating	250VAC/30VDC/8A 2Z
Outer dimension	70x85x70mm

**LK-6-2Z-NP**
**■ Character**

Input type	Terminal block input, NPN and PNP is common; AC/DC is common
Relay	OMRON
Coil voltage	12,24,48,110,220VAC/DC
Relay quantity	6
Contact rating	250VAC/30VDC/8A 2Z
Outer dimension	70x85x70mm

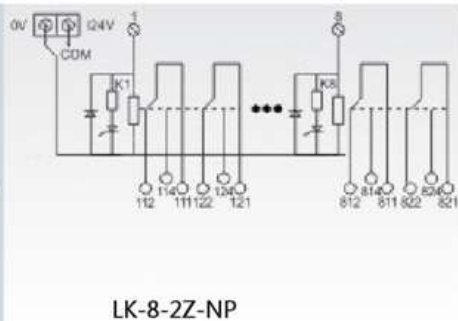
# Relay Module (For Automation)



LK-8-2Z-NP

■ Character

Input type	Terminal block input, NPN and PNP is common; AC/DC is common
Relay	OMRON
Coil voltage	12,24,48,110,220VAC/DC
Relay quantity	8
Contact rating	250VAC/30VDC/8A 2Z
Outer dimension	130x85x70mm

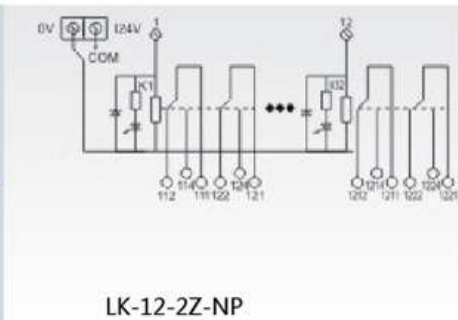

LK-12-2Z-NP

■ Character

Input type	Terminal block input, NPN and PNP is common; AC/DC is common
Relay	OMRON
Coil voltage	12,24,48,110,220VAC/DC
Relay quantity	12
Contact rating	250VAC/30VDC/8A 2Z
Outer dimension	190x85x70mm

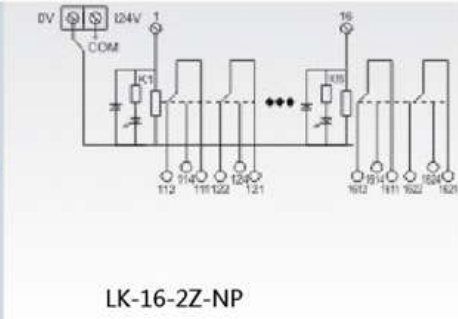

LK-16-2Z-NP

■ Character

Input type	Terminal block input, NPN and PNP is common; AC/DC is common
Relay	OMRON
Coil voltage	12,24,48,110,220VAC/DC
Relay quantity	16
Contact rating	250VAC/30VDC/8A 2Z
Outer dimension	250x85x70mm

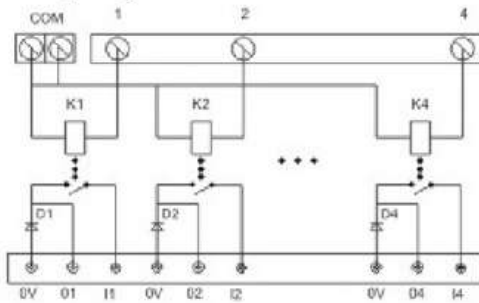
**LK-04-CR**
**Wiring Diagram**

**Character**

Input type	Terminal input, NPN and PNP is common
Relay	OMRON
Input voltage	2-32VDC
SSR quantity	2,4,6,8,12,16
Load voltage	280VAC/DC80V/5A
Load current	0.1-5A
Arc extinction circuit	Diode
Outer dimension	70x85x73mm

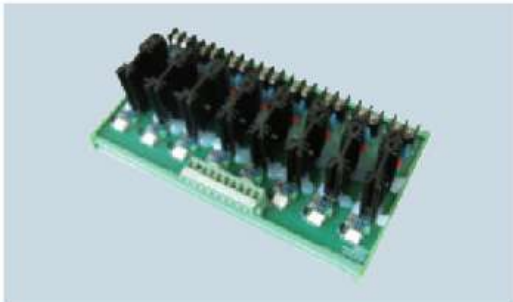
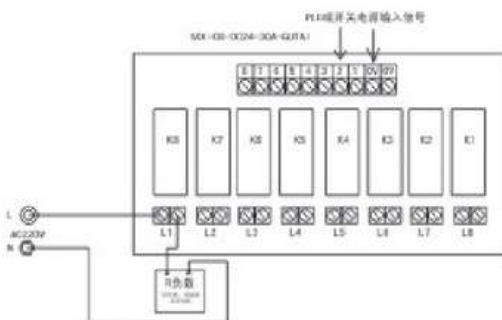
- This product output using CRYDOM relay, is designed for control AC and DC load, for example, DC motor for avoid motor of electromagnetic relay is rase spare and burn out contact, improving the reliability of modulet.
- SSR relay module's respond speed is fast.
- SSR relay module have small interference, no noise, long life, ability of electromagnetic compatibility is good, attordability of impact current is high.
- Input and output have protect circuit, to avoid damage to the upper and lower pole.
- The module is design is small size, save space, easy wiring and improve efficiently.

**LK-08-DC24V-30A-GUTAI**
**Wiring Diagram**

**Character**

Input type	Pluggable terminal input
SCR	PHILLIPS tube
Input voltage	3-32VDC
SCR quantity	2,4,6,8,12,16
Load voltage	AC220V/30A
Load current	40A
Outer dimension	210x110x70mm

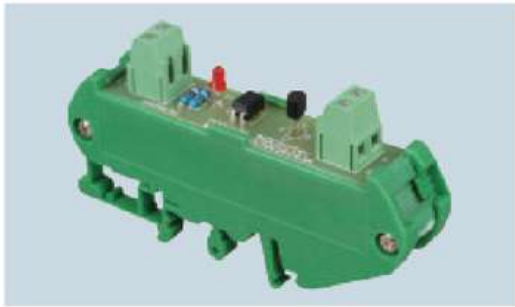
- This product is designed for control AC and DC load, for example, heating rod contactor AC motor, etc.
- The price is lower than solid state relay.
- Speed is fast, no contact.
- Input and output terminals have fault indication circuit.



LKO-1CP

### Specifications

Power Output	NN, NP, PN, PP
Driving Voltage	DC5V, 12V, 24V
Optocoupler Quantity	1
Output Current	DC24V/500mA
Outer Dimension	15x73x66mm

### Wiring Diagram

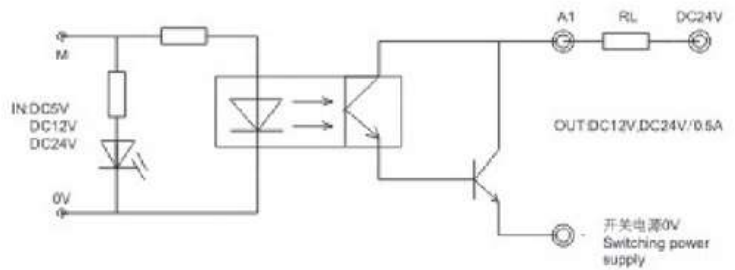

- This product output using CRYDOM relay, is designed for control AC and DC load, for example, DC motor for avoid motor of electromagnetic relay is rase spare and burn out contact, improving the reliability of modulet.
- SSR relay module's respond speed is fast.
- SSR relay module have small interference, no noise, long life, ability of electromagnetic compatibility is good, attordability of impact current is high.
- Input and output have protect circuit, to avoid damage to the upper and lower pole.
- The module is design is small size, save space, easy wiring and improve efficiently.



LKO-4CP

### Specifications

Power Output	NN, NP, PN, PP
Driving Voltage	DC5V, 12V, 24V
Optocoupler Quantity	4
Output Current	DC24V/500mA
Outer Dimension	30x73x66mm

### Wiring Diagram

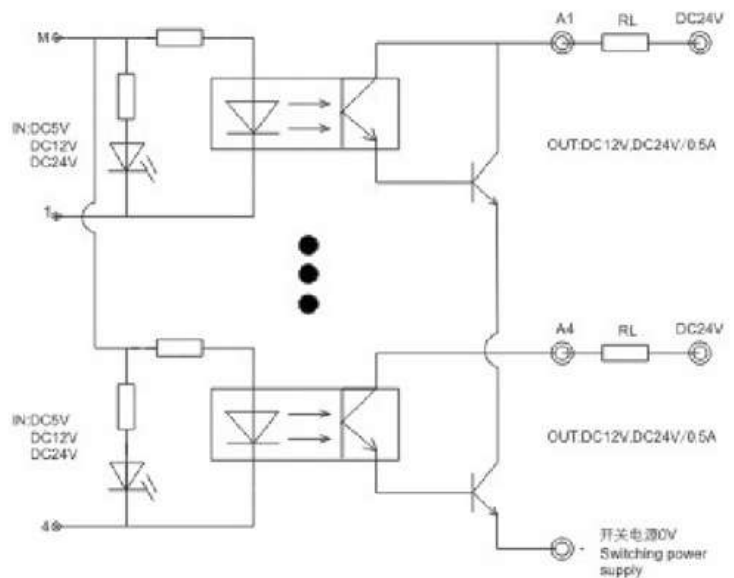



LKO-8CP

Specifications

Power Output	NN, NP, PN, PP
Driving Voltage	DC5V, 12V, 24V
Optocoupler Quantity	8
Output Current	DC24V/500mA
Outer Dimension	55x73x66mm

Wiring Diagram

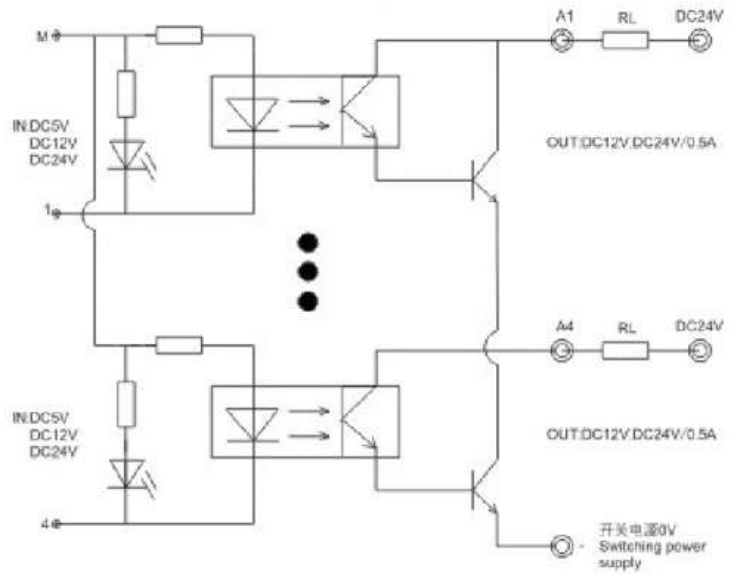

LKO-16CP

Specifications

Power Output	NN, NP, PN, PP
Driving Voltage	DC5V, 12V, 24V
Optocoupler Quantity	16
Output Current	DC24V/500mA
Outer Dimension	110x73x66mm

Wiring Diagram

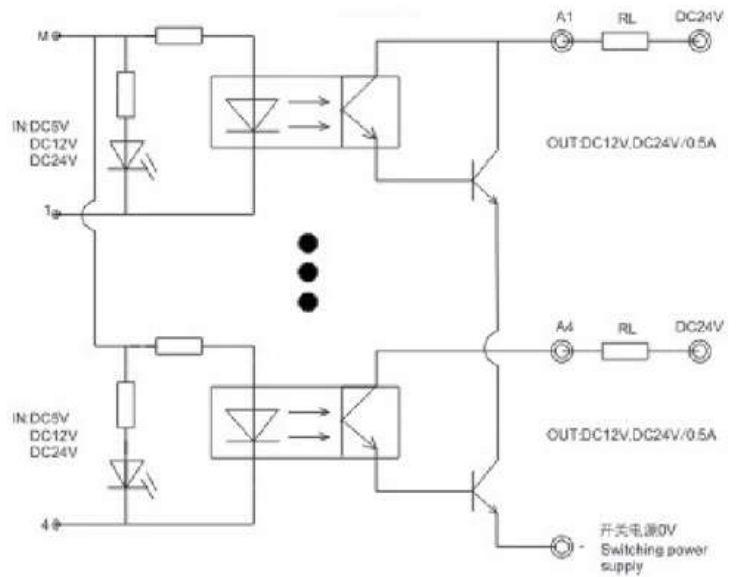



LK-8-PN-PA1A-50MM

■ Character

Input type	Terminal input, NPN and PNP is common; AC and DC is common
Relay	PA1A
Coil voltage	DC24V
Relay quantity	4,6,8,12,16
Contact rating	250VAC/30VDC/5A/1Z
Outer dimension	70x50x66mm

Product advantages

- Input Method: IDC terminal block horns and two input methods;
- Space saving, specifically for small control cabinet space, old-fashioned MY2 series quarter;
- Product output common terminal using two different load Convenient customer access time savings wire input uses a common ground line, so that saves wires, space-saving role.

Wiring Diagram

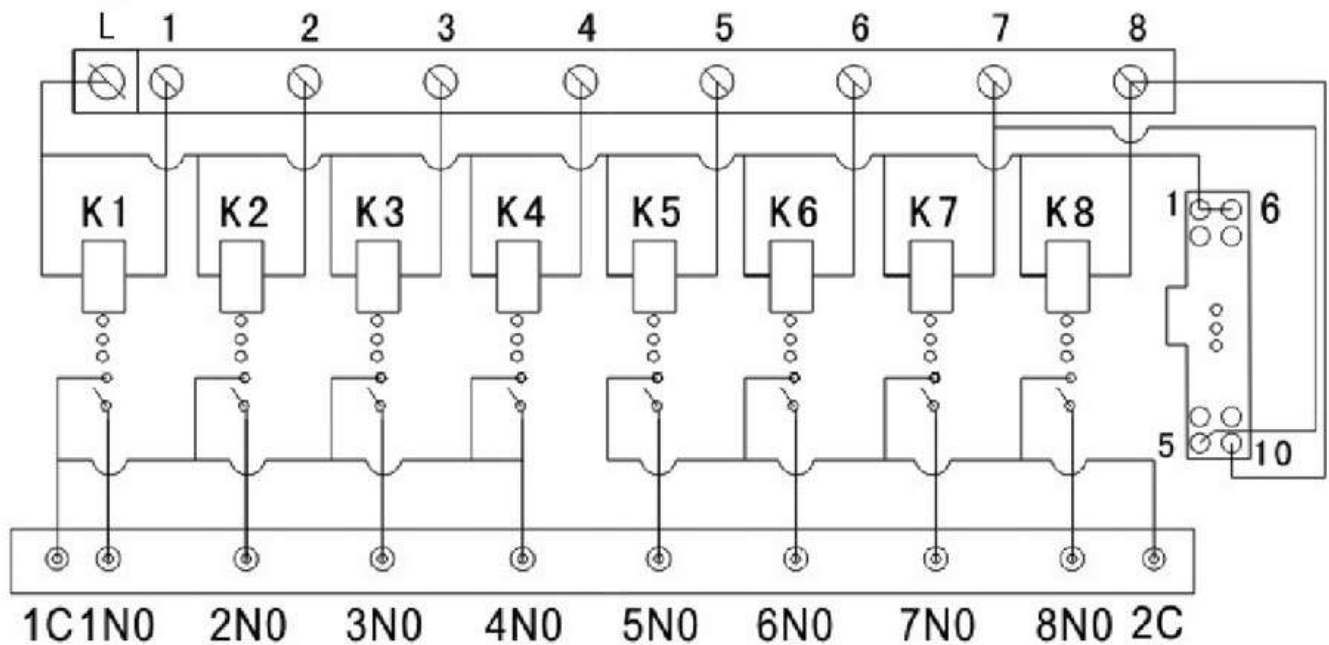

Relay Module

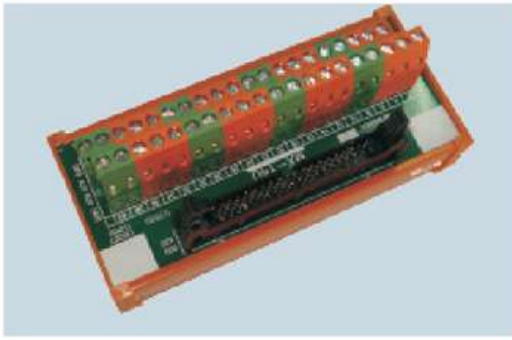

Mitsubishi QX series PLC input dedicated board

Wiring Diagram

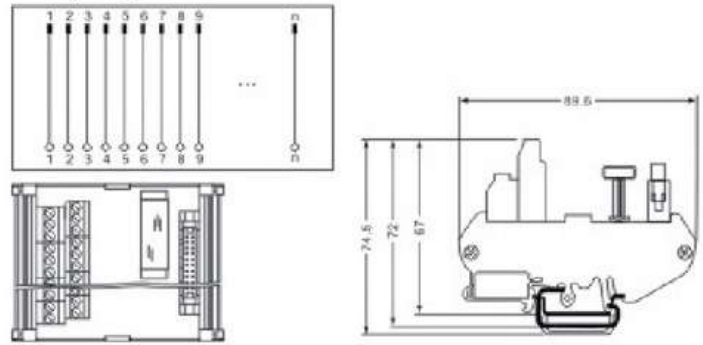

Product performance Comparison

LK-F Series plug-in terminal module connects the basic pin 10 to pin 64 of pin socket with double screw terminals via a circuit board. To select pin position, please use multi-pin flat cable plug (Follow IEC603-1/DIN41651 standard) and leading to the industrial field's double terminal wire. Thus, to connect by numbers corresponding to the standard rail of NS 35/7.5 or NS32 which is versatile, reliable, easy and safe usage. Module can be labeled by mark base or use ZB. mark on cover, but it needs to order separately.

Technical Parameter

Wire cross-section	0.2-2.5mm <sup>2</sup>
I Allowable current	1A
U Allowable voltage	AC/DC 60V

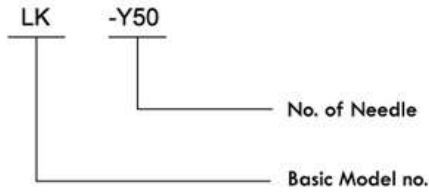

Performance Parameters

Model	Pin No.	Thickness of module board	Layout for connector and terminal No.
LK-F10	10	45	
LK-F14	14	45	
LK-F16	16	67.5	
LK-F20	20	67.5	
LK-F26	26	96	
LK-F34	34	112.5	
LK-F40	40	112.5	
LK-F50	50	135	
LK-F60	60	180	
LK-F64	64	180	



LK-F26-2.54



Wiring Diagram

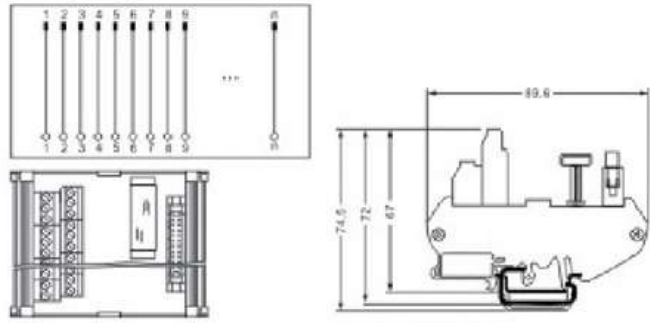

LK-F34-2.54



Wiring Diagram

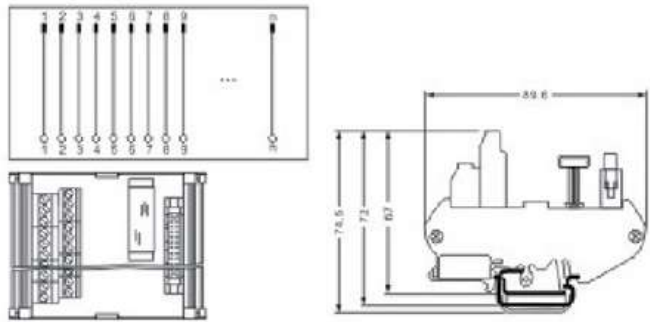

LK-F40-2.54



Wiring Diagram

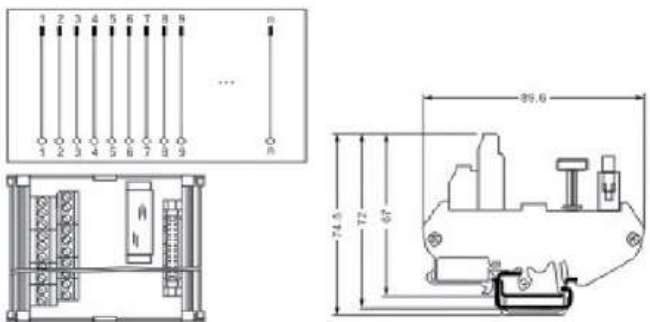

LK-F50-2.54

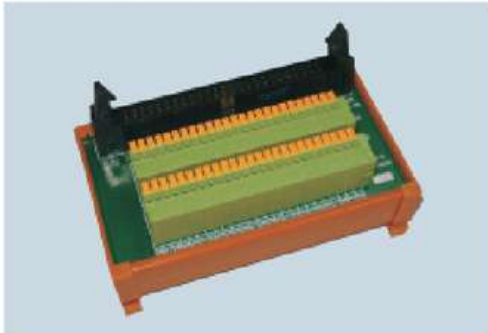

Wiring Diagram

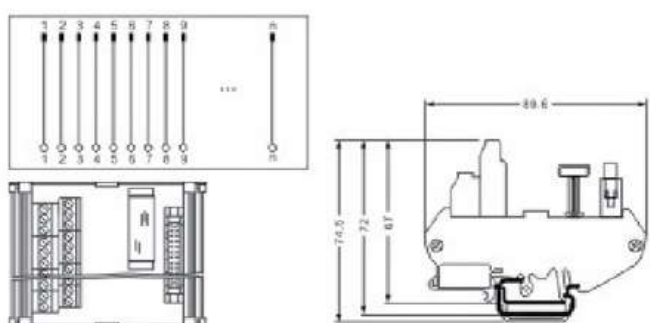



# Transformer



**Overview**

LDZ DC power supply compact construction, goodlooking, small ripple,low power consumption,big capacity and so on.Suitable for circuit with AC 50/60Hz,input voltage less than 500V and output voltage 20V.

**Features**

1. Comply with IEC standard and integrate transformer and recitify power.
2. Rated input voltage has  $\pm 5\%$  tapping,Iron core adopt air protection argon welding .
3. Swift fuse protection,protection grade up to IP20.

Rated input voltage: AC220V $\pm 5\%$ , AC380V $\pm 5\%$

Rated output voltage: DC24V

Rated input current: 2A,5A,10A

Rated load input voltage:  $95\%U_n \leq U_m \leq 105\%U_n$

Efficiency:  $>75\%$

Ripple coefficient:  $\leq 5\%$  ( JSZ  $\leq 2\%$  )

frequencywithstand voltage: AC2500V 1min / AC1000V 1min

Environment temperature:  $-5^\circ\text{C} \sim +40^\circ\text{C}$

Transformer

**Type and meaning**

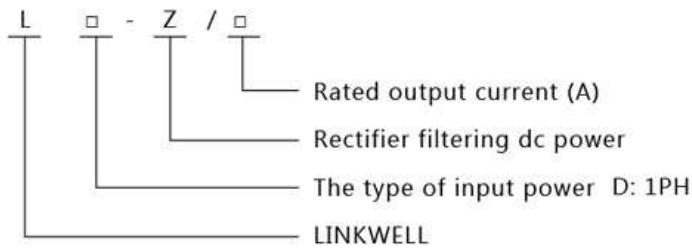

**Circuit diawing**

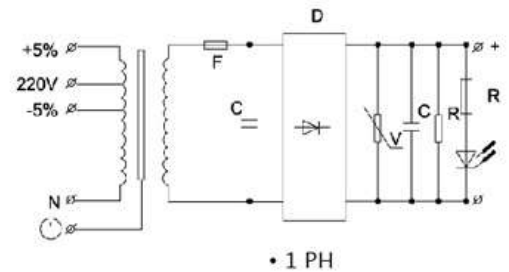

**Appearance and installing size**

LDZ-2、5、10

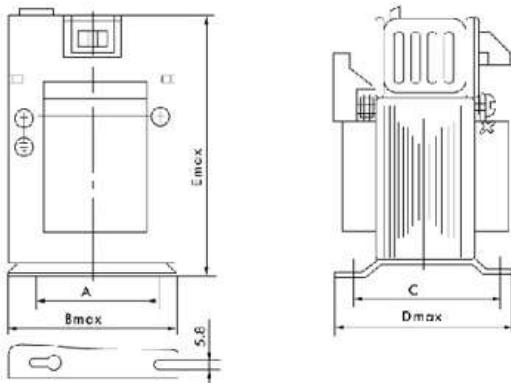

Model	LDZ-2	LDZ-5	LDZ-10
B max	78	96	120
D max	72	93	100
E max	100	133	168
A	56	84	90
C	46	73.5	85



Adopting technology of Siemens company, we design and manufacture JSG series three phase transformer with voltage between 160VA and 16KVA. The figure and installation size have been standardized and can be used together with 4AP series of Siemens.

JSG series transformer used for equipment with input and output voltage less than 500V and frequency 50-60Hz.

Product complies with VDE0550, IEC439, JB5555, GB5226 standard.

### Appearance and installing size

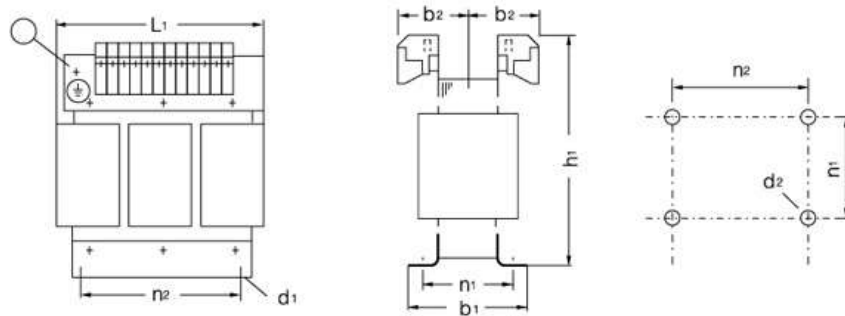

Model	Capacity KVA	b1 max	b2 max	d1	d2	h1 max	L1 max	n1	n2
JSG-0.16	0.16	64	50	5×8	M4	140	122	49	90
JSG-0.25	0.25	67	48	6×12	M5	162	156	49	113
JSG-0.4	0.4	82	56	6×12	M5	162	156	64	113
JSG-0.63	0.63	76	51	7.4×13	M6	187	181	56	136
JSG-1	1	97	61	7.4×13	M6	187	181	76	136
JSG-1.6	1.6	115	98	7.4×13	M6	214	229	94	170
JSG-2.5	2.5	133	102	10×18	M8	241	264	101	200
JSG-4	4.0	148	104	10×18	M8	250	270	118	224
JSG-6.3	6.3	155	129	10×18	M8	320	360	118	264
JSG-8	8	170	134	12×20	M10	380	420	140	315
JSG-10	10	170	134	12×20	M10	380	420	140	315



# SG series low-voltage three phase dry-type transformer



Mainly used for power exchange, illumination electric, power and current rectify.

Capacity: 0.5-100KVA.

Input voltage: 660 and 380 V.

Way of connection: Y or Delta.

Appearance and installing size

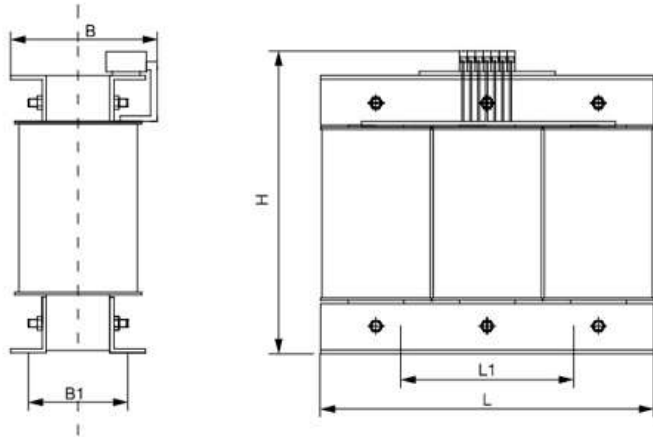

Model	Capacity KVA	Input voltage		Outline size			Installation size		Hole radius		
				L	B	H	L1	B1			
SG-2.5	2.5	660	△ 或 Y	270	180	260	200	102	8.5		
SG-3	3			270	190	260	200	102	8.5		
SG-4	4			300	190	290	224	120	8.5		
SG-5	5			300	210	290	224	135	8.5		
SG-6	6			360	200	350	264	127	8.5		
SG-7	7			360	200	370	264	127	8.5		
SG-8	8			360	240	370	264	142	8.5		
SG-10	10			420	240	420	315	150	12.5		
SG-12	12			420	240	420	315	150	12.5		
SG-15	15			420	280	420	315	170	12.5		
SG-20	20			380	△ 或 Y	480	240	450	360	150	12.5
SG-25	25					480	240	450	360	180	12.5
SG-30	30					480	270	450	360	220	12.5
SG-40	40					540	300	450	360	250	12.5
SG-45	45					600	300	560	450	250	12.5
SG-50	50					600	350	560	450	220	12.5
SG-60	60	600	350			560	450	220	15		
SG-80	80	660	380			660	550	250	15		
SG-100	100	660	380			660	550	250	15		

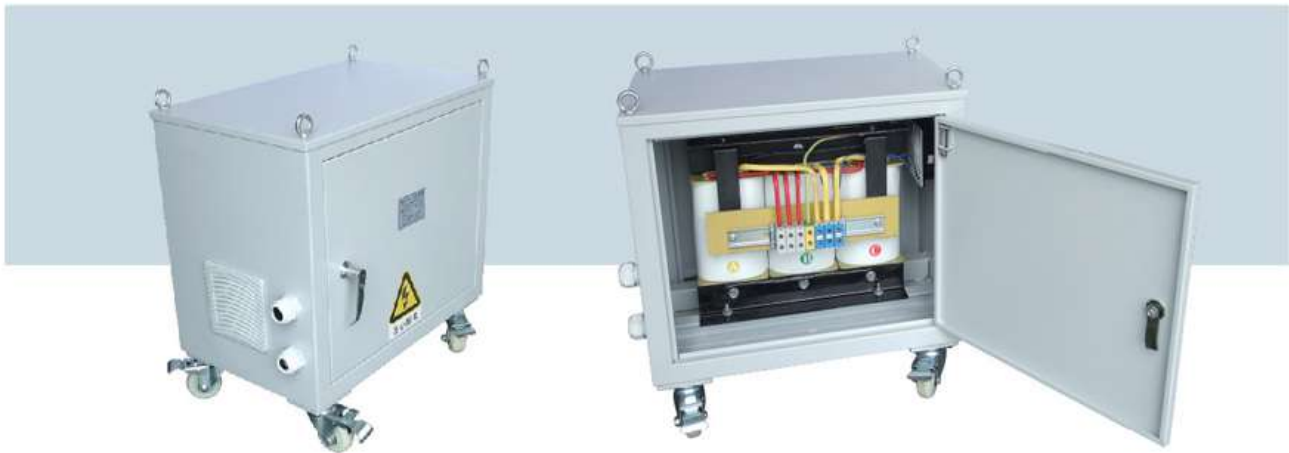

Appearance and installing size

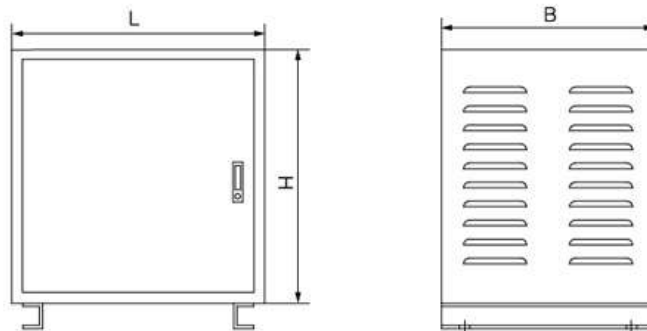

Type	Rated volume (KVA)	Outline size		
		L	B	H
SGC-2.5KVA	2.5	300	240	280
SGC-3KVA	3	300	240	280
SGC-4KVA	4	390	280	320
SGC-5KVA	5	390	280	320
SGC-6KVA	6	390	280	320
SGC-8KVA	8	500	350	450
SGC-10KVA	10	500	350	450
SGC-12KVA	12	500	350	450
SGC-15KVA	15	500	350	450
SGC-20KVA	20	600	420	520
SGC-25KVA	25	600	420	520
SGC-30KVA	30	600	420	520
SGC-40KVA	40	600	420	520
SGC-45KVA	45	740	500	650
SGC-50KVA	50	740	500	650
SGC-60KVA	60	740	500	650
SGC-80KVA	80	840	530	650
SGC-100KVA	100	840	530	650



# Series JBK5 machine controlling transformer



## Type and meaning

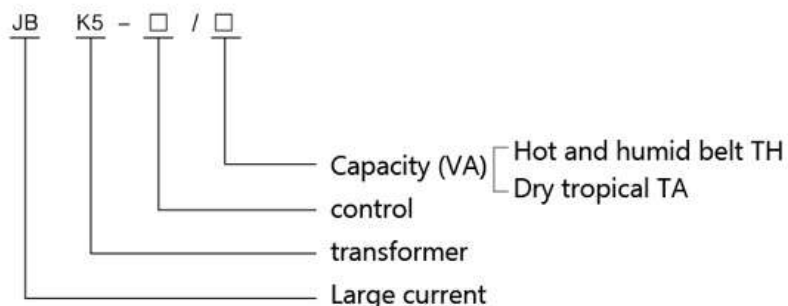

Type	Rated volume (VA)	Efficiency (%)	voltage of output under load		Voltage of output unloaded		rated input voltage (v)	rated output voltage (v)	Remarks	
			Signal winding (%)	Control winding (%)	Signal winding (%)	Control winding (%)				
JBK5-40	40	80					AC380 ±5%	AC220 (127) 110		
JBK5-63	63									
JBK5-100	100									
JBK5-160	160	85	6≥Um > 5 12≥Um > 10					Control		
JBK5-250	250									
JBK5-400	400									
JBK5-630	630	90	6≥Um > 4.5 12≥Um > 9	95%-105% UH	6或12	1.1Um	AC220 ±5%	48 35 24	Light or Control	The distribution of every winding capacity can be made according to user's demand
JBK5-800	800									
JBK5-1000	1000									
JBK5-1600	1600	90	12.8≥Um > 9.6 13.5≥Um > 10					Signal		
JBK5-2500	2500									
JBK5-3000	3000									
JBK5-4000	4000	90	15.2≥Um11				0-380 or 0-220 without ±5%	12 6		
JBK5-5000	5000									
JBK5-6000	6000									
JBK5-7000	7000	90								
JBK5-8000	8000									
JBK5-10000	10000									
JBK5-15KVA	15000	90								
JBK5-20KVA	20000									
JBK5-30KVA	30000									
JBK5-40KVA	40000	90								
JBK5-50KVA	50000									
JBK5-60KVA	60000									

Transformer

## Series JBK5 machine controlling transformer



Type	B max	D max	E max	Hole distance A	Hole distance C	Installing hole K	F max	Remarks
JBK5-40, 63	78	72	90	56±0.15	46±0.125	4.6	1.5	
JBK5-100	85	75	96	64±0.15	62±0.15	4.6	1.5	
JBK5-160	96	92	105	84±0.175	73.5±0.15	5.5	1.5	
JBK5-250	96	100	104	84±0.175	85±0.175	5.8	1.5	
JBK5-400	120	100	122	90±0.175	85±0.175	5.8	2	
JBK5-500	120	110	122	90±0.175	96±0.175	5.8	2	
JBK5-630	150	110	140	122±0.2	90±0.175	7	2	
JBK5-800	150	128	142	122±0.2	105±0.2	7	2	
JBK5-1000	150	190	142	155±0.2	126±0.2	7	3	Horizontal
JBK5-1000	168	125	155	138±0.2	105±0.2	9	2	Vertical
JBK5-1600	170	225	153	176±0.2	140±0.2	7	3	Horizontal
JBK5-1600	168	138	155	138±0.2	116±0.2	9	2	Vertical
JBK5-2500	194	250	170	200±0.2	170±0.23	7	4	Horizontal
JBK5-3000	194	250	190	200±0.2	170±0.23	7	4	Horizontal
JBK5-4000	194	250	200	200±0.2	170±0.23	7	4	Horizontal
JBK5-5000	220	286	215	240±0.5	208±0.5	9	6	Horizontal
JBK5-6000	220	286	215	240±0.5	208±0.5	9	6	Horizontal
JBK5-7000	280	205	260	200±0.5	180±0.5	12	7	Vertical
JBK5-8000	280	205	260	200±0.5	180±0.5	12	7	Vertical
JBK5-10000	280	250	260	200±0.5	215±0.5	12	7	Vertical

### Main Technical Parameter

Type	Rated volume (VA)	Efficiency (%)	voltage of output under load		Voltage of output unloaded		rated input voltage (v)	rated output voltage (v)	Remarks
			Signal winding (%)	Control winding (%)	Signal winding (%)	Control winding (%)			
JBK5-40	40	80	6≥Um>5 12≥Um>10	95%-105% UH	6 or 12	1.1Um	AC380 ±5%	AC220 (127) 110	The distribution of every winding capacity can be made according to user's demand
JBK5-63	63								
JBK5-100	100								
JBK5-160	160								
JBK5-250	250								
JBK5-400	400								
JBK5-630	630	85	6≥Um>4.5 12≥Um>9	95%-105% UH	6 or 12	1.1Um	AC220 ±5%	48 35 24	
JBK5-800	800								
JBK5-1000	1000								
JBK5-1600	1600								
JBK5-2500	2500	90	12.8≥Um>9.6 13.5≥Um>10	95%-105% UH	6 or 12	1.1Um	AC220 ±5%	12	
JBK5-3000	3000								
JBK5-4000	4000								
JBK5-5000	5000								
JBK5-6000	6000	96	15.2≥Um11	95%-105% UH	6 or 12	1.1Um	0-380 or 0-220 without ±5%	6	
JBK5-7000	7000								
JBK5-8000	8000								
JBK5-10000	10000								

### Appearance and installing size

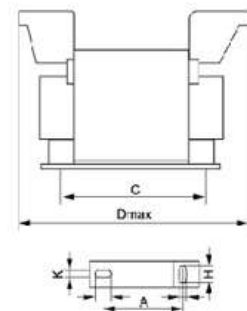
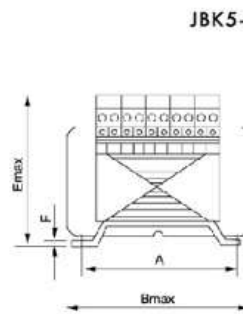
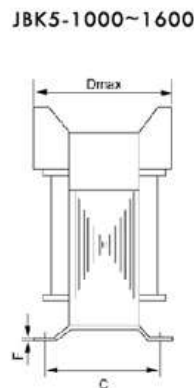
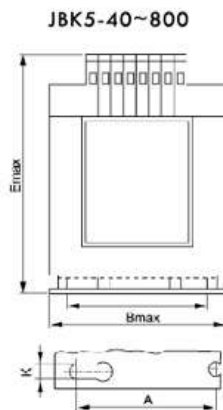

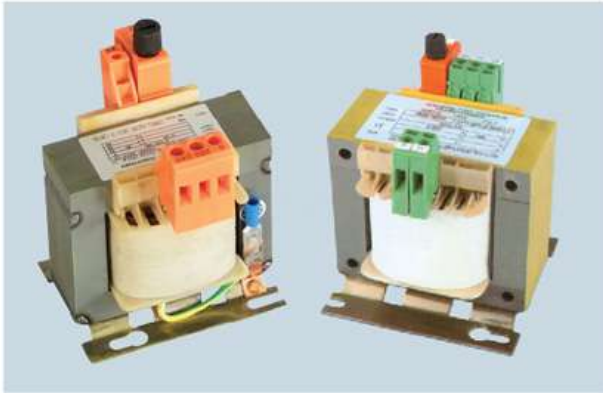

## Series JBK5 machine controlling transformer

### Summary

Series JBK6 machine controlling transformer is our company introduces the series of the foreign latest transformer, on the basis of the JBK5 controlling transformer, develop the new generation transformer, JBK6 transformer's appearance size, installation size, and the occasion of using are same as JBK5 transformer, besides JBK5 transformer's advantage, JBK6 transformer has the following characteristic:

1. The terminal screw is bigger than JBK 5, it is more convenient and firmer to wire.
2. With shortcut and hot protector, it is more reliable to use.
3. The transformer adopts the craft of vacuum soak painting, the insulating material import from foreign country, insulating ability is more steady.

### Appearance and installing size

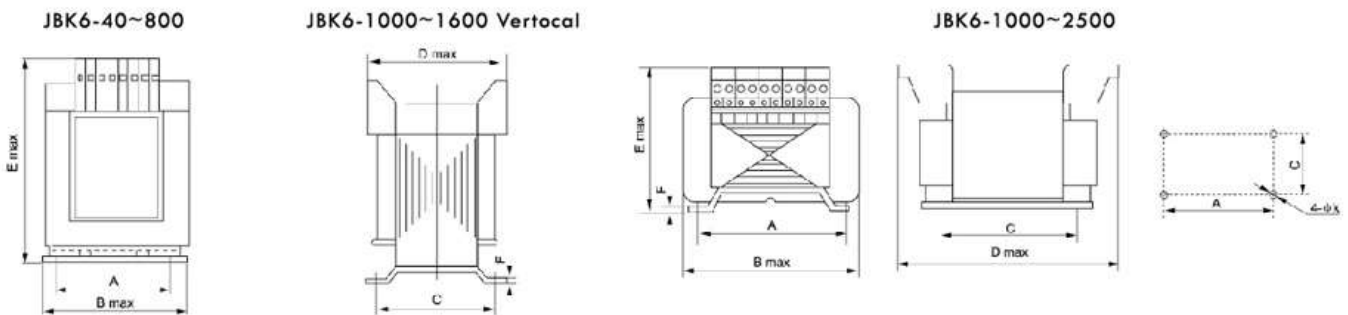

Type	B max	D max	E max	Hole distance A	Hole distance C	Installing hole K	F max	Remarks
JBK6-40、63	78	72	90	56±0.15	46±0.125	4.6	1.5	
JBK6-100	85	75	96	64±0.15	62±0.15	4.6	1.5	
JBK6-160	96	92	105	84±0.175	73.5±0.15	5.5	1.5	
JBK6-250	96	100	104	84±0.175	85±0.175	5.8	1.5	
JBK6-400	120	100	122	90±0.175	85±0.175	5.8	2	
JBK6-630	150	110	140	122±0.2	90±0.175	7	2	
JBK6-800	150	128	142	122±0.2	105±0.2	7	2	
JBK6-1000	150	190	142	126±0.2	155±0.2	7	3	Horizontal
JBK6-1000	168	125	155	105±0.2	138±0.2	9	2	Vertical
JBK6-1600	170	225	153	140±0.2	176±0.2	7	3	Horizontal
JBK6-1600	168	138	155	116±0.2	138±0.2	9	2	Vertical
JBK6-2500	194	160	165	172±0.2	195±0.23	7	4	Horizontal

### Main Technical Parameter

Type	Rated volume (VA)	Efficiency (%)	voltage of output under load		Voltage of output unloaded		rated input voltage (v)	rated output voltage (v)	Remarks
			Signal winding (%)	Control winding (%)	Signal winding (%)	Control winding (%)			
JBK6-40	40	80	6≥Um>5 12≥Um>10	95%-105% UH	6 or 12	1.1Um	AC380 ±5%	AC220	The distribution of every winding capacity can be made according to user's demand
JBK6-63	63							(127)	
JBK6-100	100							110	
JBK6-160	160	85	6≥Um>5 12≥Um>10	95%-105% UH	6 or 12	1.1Um	AC380 ±5%	48	
JBK6-250	250							35	
JBK6-400	400							24	
JBK6-630	630	90	6≥Um>4.5 12≥Um>9	95%-105% UH	6 or 12	1.1Um	AC220 ±5%	12	
JBK6-800	800							6	
JBK6-1000	1000							Signal	
JBK6-1600	1600								
JBK6-2500	2500								

The installing guide is designed according to the new Europe standard EN 50 022,EN 50 035,EN50 045. It has a precise height,strict tolerance,fine surface and good finish.The steel guide has been zinc-plated and yellow processed. For the convenience of installing and making holes,there is a line printed on the center of guide which also exists on the aluminum and copper guide.length and can be with round hole,long hole,or trough.



**TS 15/5.5**

Model	Packing
According to EN 50 045-15×5mm Made of steel,yellow, Without hole length:2m	
NS 15/5.5 Without hole	1



**TS 35/7.5**

Model	Packing
According to EN 50 022-35×7.5mm Made of steel,yellow, Without hole length:2m	
NS 35/7.5 Without hole	1

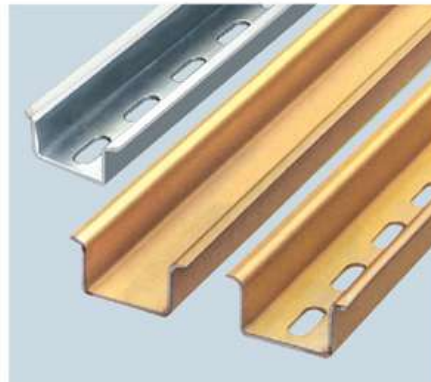
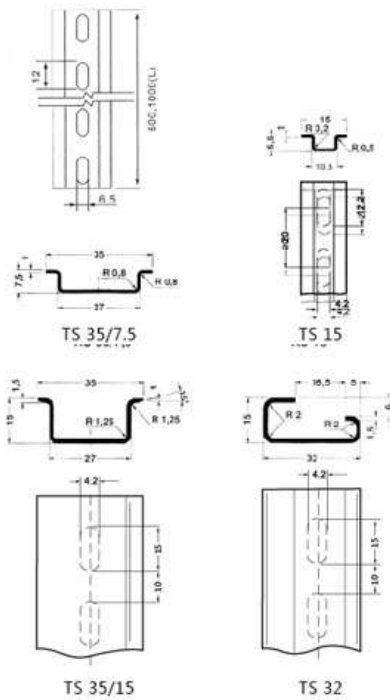

**TS 35/15**

Model	Packing
According to EN 50 022 35×15mm Made of thick steel plate of 1.5mm High section,Without hole length:2m	
TS 35/15 Without hole	1

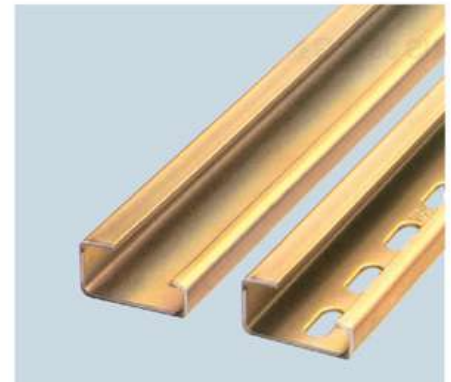

**TS 32**

Model	Packing
According to EN 50 035-G 32 Made of steel,Without hole length:2m	
TS 32 Without hole	1

**DIN rail retainer TSTW**



T: 2mm

**Aluminum DIN rail**

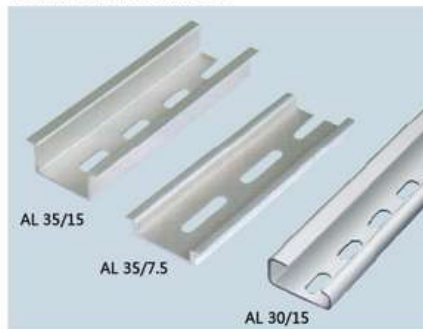

AL 35/15 thickness: 1.5mm  
AL 35/7.5 thickness: 1.1mm or 1.5mm  
AL 30/15 thickness: 1mm or 2mm

**DIN rail cutter**



For: Aluminum Din rail NSL35/7.5(1.5mm)  
Aluminum Din rail NSL35/7.5(1 mm)



## Din Rail Cutter

LKDC-002



LKDC-002 Standard Din Rail Cutter.

Used for: Din Rail W35\*H7.5\*T1.0mm or W35\*H15\*T1.5mm, customizable for other size Din Rail.

Use Method and Notes:

- 1, Lift the handle, insert the Din Rail into the matching cavity, make it vertical to the cavity surface at the same time and Din Rail will go through, press the handle, Din Rail will be cut off.
- 2, Choose the flat ground during the operation, it ensures the cutter base bear stress evenly and reduces the stress on cavity.

LKDC-003



LKDC-003 Bench Type Din Rail Cutter

This cutter needs to be installed on a workbench, it can cut any size Din Rail with the assistance of a measure gauge. Humanization design, no need to bend over when operate it.

Use Method and Notes:

- 1, Lift the handle, insert the Din Rail into the matching cavity, make it vertical to the cavity surface at the same time and Din Rail will go through, press the handle, Din Rail will be cut off.
- 2, Choose the flat ground during the operation, it ensures the cutter base bear stress evenly and reduces the stress on cavity.

LKWC-001



LKWC-001 Wiring Duct Cutter











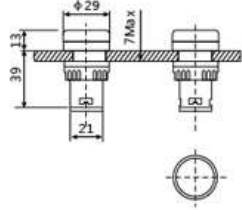

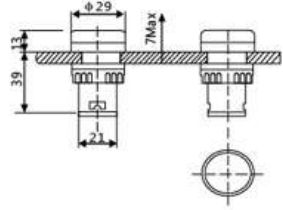

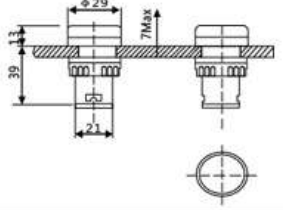

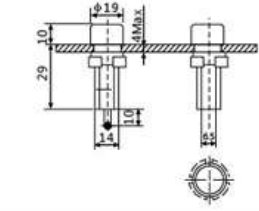
Used to cut wiring duct and cover, Max available width: 125mm

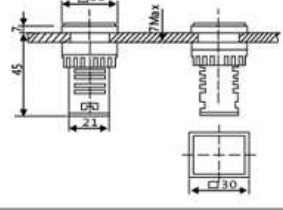
High strength cutting blade, anti-abrasion.

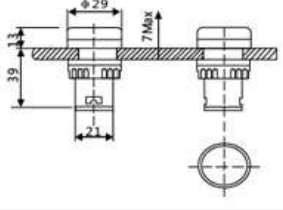

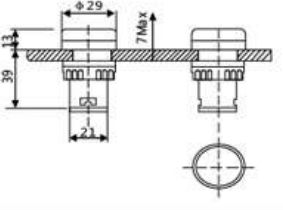

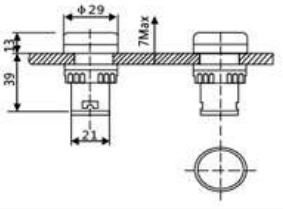





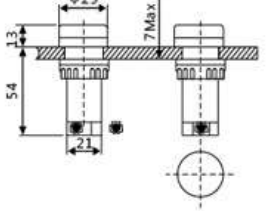

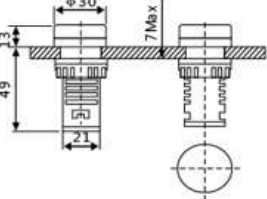

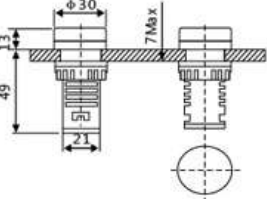

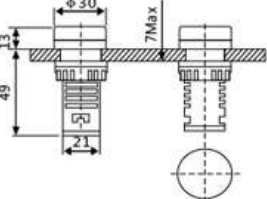
High efficient, free of burrs after cutting.

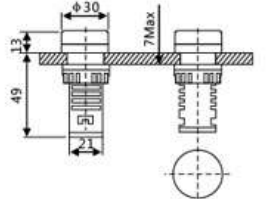

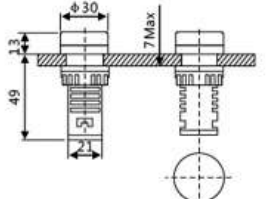

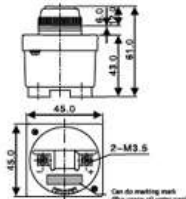

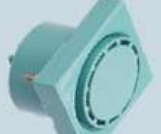
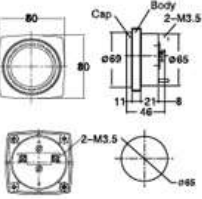



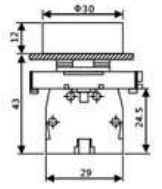

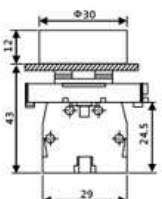

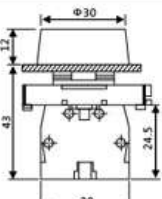

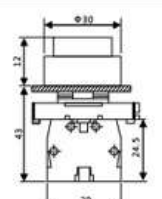

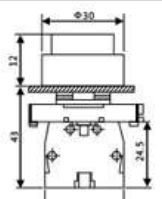

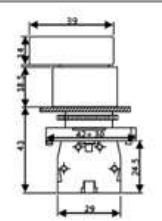

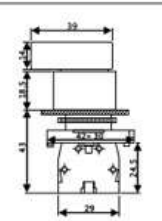

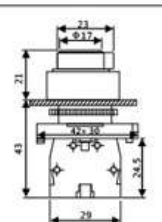



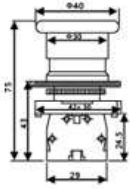

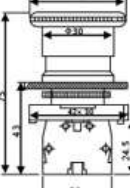

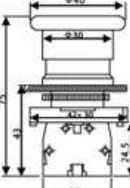

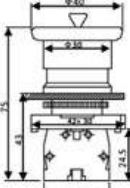
# Push Button & Indicator

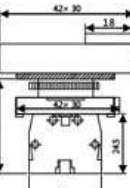
	<b>AD16-16DS</b>	21-DC.AC6V 22-DC.AC12V 23-DC.AC24V 24-DC.AC36V 25-DC.AC48V 26-DC.AC110V 27-DC.AC127V 28-DC.220V 31-AC220V 32-AC380V		
	<b>AD22-22DS</b>	21-DC.AC6V 22-DC.AC12V 23-DC.AC24V 24-DC.AC36V 25-DC.AC48V 26-DC.AC110V 27-DC.AC127V 28-DC.220V 31-AC220V 32-AC380V		
	<b>AD22-30DS</b> φ 30	21-DC.AC6V 22-DC.AC12V 23-DC.AC24V 24-DC.AC36V 25-DC.AC48V 26-DC.AC110V 27-DC.AC127V 28-DC.220V 31-AC220V 32-AC380V		
	<b>AD22-16B</b>	21-DC.AC6V 22-DC.AC12V 23-DC.AC24V 24-DC.AC36V 25-DC.AC48V 26-DC.AC110V 27-DC.AC127V 28-DC.220V 31-AC220V 32-AC380V		
	<b>AD22-22FS/</b>	21-DC.AC6V 22-DC.AC12V 23-DC.AC24V 24-DC.AC36V 25-DC.AC48V 26-DC.AC110V 27-DC.AC127V 31-AC220V 32-AC380V		
	<b>AD22-22BS</b>	21-DC.AC6V 22-DC.AC12V 23-DC.AC24V 24-DC.AC36V 25-DC.AC48V 26-DC.AC110V 27-DC.AC127V 28-DC.220V 31-AC220V 32-AC380V		
	<b>AD22-22CS</b>	21-DC.AC6V 22-DC.AC12V 23-DC.AC24V 24-DC.AC36V 25-DC.AC48V 26-DC.AC110V 27-DC.AC127V 28-DC.220V 31-AC220V 32-AC380V		
	220V XB2-BVM1LC XB2-BVM3LC XB2-BVM4LC XB2-BVM5LC XB2-BVM6LC  24V XB2-BVB1LC XB2-BVB3LC XB2-BVB4LC XB2-BVB5LC XB2-BVB6LC	380V XB2-BVQ1LC XB2-BVQ3LC XB2-BVQ4LC XB2-BVQ5LC XB2-BVQ6LC  110V XB2-BVF1LC XB2-BVF3LC XB2-BVF4LC XB2-BVF5LC XB2-BVF6LC		

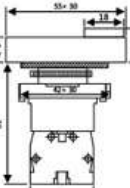

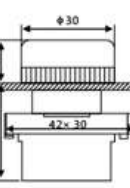

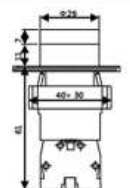





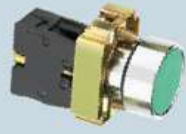
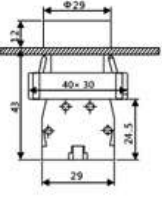





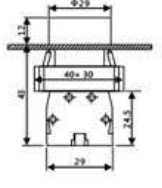

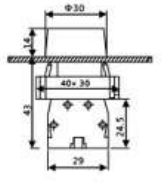

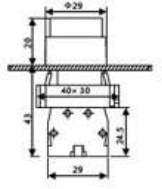





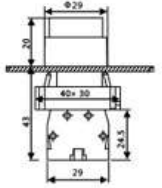



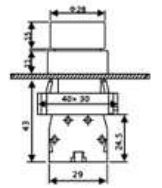

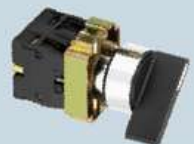

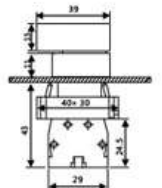

Push Button & Indicator

	<p>Double color indicator light</p> <p>AD22-22DRG/</p>	<p>26-DC.AC110V 27-DC.AC127V 28-DC220V 31-AC220V 32-AC380V</p>		
	<p>Isolation brake position indicator</p> <p>AD22-22W/G</p>	<p>23-DC.AC 24V 24-DC.AC 36V 25-DC.AC 48V 26-DC.AC 110V 27-DC.AC 127V 28-DC.AC 220V 31-AC 220V 32-AC 380V X0X1 power on - Red light X0X2 power on - Green light</p>		
	<p>Circuit breaker position indicator</p> <p>AD22-22W/D</p>	<p>23-DC.AC 24V 24-DC.AC 36V 25-DC.AC 48V 26-DC.AC 110V 27-DC.AC 127V 28-DC.AC 220V 31-AC 220V 32-AC 380V X0X1 power on Red light X0X2 power on Green light</p>		
	<p>Grounding position indicator</p> <p>AD22-22W/N</p>	<p>23-DC.AC 24V 24-DC.AC 36V 25-DC.AC 48V 26-DC.AC 110V 27-DC.AC 127V 28-DC.AC 220V 31-AC 220V 32-AC 380V X1X2 power on Red light</p>		
	<p>Flash Buzzer</p> <p>AD22-22SM/R</p>	<p>22-DC.AC12V 23-DC.AC24V 24-DC.AC36V 25-DC.AC48V 26-DC.AC110V 27-DC.AC127V 28-DC220V 31-AC220V 32-AC380V</p>		
	<p>Buzzer</p> <p>AD22-22FMD/</p>	<p>21-DC.AC6V 22-DC.AC12V 23-DC.AC24V 24-DC.AC36V 25-DC.AC48V 26-DC.AC110V 27-DC.AC127V 28-DC220V 31-AC220V 32-AC380V</p>		
	<p>phi 25 Buzzer</p> <p>KH-4025-D phi 25 HRB-PS60A2 phi 30</p>	<p>AC/DC12V AC/DC24V AC/DC110V AC220V AC380V Power consumption DC: 25ma Maximum power 1W(PEAK) Volume More than 60 dB IP40 Withstand voltage: 1,000VAC 1 Minute</p>		
	<p>phi 65 Cover up into the type buzzer</p> <p>HRB-P80A2</p>	<p>A2(220VAC) A1(110VAC) D2(12VAC/DC) D4(24VAC/DC) D1(110VAC/DC)</p>		

	<p><b>Even button spring return</b></p> <p>LAY5-EA11(XB2-EA11) NO            LAY5-EA21(XB2-EA21) NO            LAY5-EA31(XB2-EA31) NO            LAY5-EA42(XB2-EA42) NC            LAY5-EA51(XB2-EA51) NO            LAY5-EA61(XB2-EA61) NO            LAY5-EA25(XB2-EA25) NO+NC            LAY5-EA35(XB2-EA35) NO+NC            LAY5-EA45(XB2-EA45) NO+NC</p>	 
	<p><b>Even button spring return With symbol logo</b></p> <p>LAY5-EA3311(XB2-EA3311) NO I            LAY5-EA3361(XB2-EA3361) NO II            LAY5-EA3341(XB2-EA3341) NO III            LAY5-EA3351(XB2-EA3351) NO IV            LAY5-EA4322(XB2-EA4322) NC O            LAY5-EA4342(XB2-EA4342) NC STOP            LAY5-EA5331(XB2-EA5331) NO START            LAY5-EA5321(XB2-EA5321) NO START</p>	 
	<p><b>Button with protective cover</b></p> <p>LAY5-EP11(XB2-EP11) NO            LAY5-EP21(XB2-EP21) NO            LAY5-EP31(XB2-EP31) NO IP 65            LAY5-EP42(XB2-EP42) NC            LAY5-EP51(XB2-EP51) NO            LAY5-EP61(XB2-EP61) NO</p>	 
	<p><b>Protruding button</b></p> <p>LAY5-EL21(XB2-EL21) NO            LAY5-EL31(XB2-EL31) NC            LAY5-EL42(XB2-EL42) NO            LAY5-EL51(XB2-EL51) NO            LAY5-EL61(XB2-EL61) NO</p>	 
	<p><b>Protruding button spring return With symbol logo</b></p> <p>LAY5-EL3311(XB2-EL3311) NO I            LAY5-EL3361(XB2-EL3361) NO II            LAY5-EL3341(XB2-EL3341) NO III            LAY5-EL3341(XB2-EL3341) NO IV            LAY5-EL4322(XB2-EL4322) NC O            LAY5-EL4342(XB2-EL4342) NC STOP</p>	 
	<p><b>Standard handle knob</b></p> <p>LAY5-ED21(XB2-ED21) NO 2-position locked            LAY5-ED25(XB2-ED25) NO+NC 3-position locked            LAY5-ED33(XB2-ED33) NO+NO 2-position locked            LAY5-ED41(XB2-ED41) NO 2-position reset            LAY5-ED45(XB2-ED45) NO 2-position reset            LAY5-ED53(XB2-ED53) NO+NO 3-position reset</p>	 
	<p><b>Long handle knob</b></p> <p>LAY5-EJ21(XB2-EJ21) NO 2-position locked            LAY5-EJ25(XB2-EJ25) NO+NC 3-position locked            LAY5-EJ33(XB2-EJ33) NO+NO 2-position locked            LAY5-EJ41(XB2-EJ41) NO 2-position reset            LAY5-EJ45(XB2-EJ45) NO 2-position reset            LAY5-EJ53(XB2-EJ53) NO+NO 3-position reset</p>	 
	<p><b>Key button</b></p> <p>LAY5-EG21(XB2-EG21) NO 2-position locked            LAY5-EG25(XB2-EG25) NO+NC 2-position locked            LAY5-EG03(XB2-EG03) NO+NO 3-position locked            LAY5-EG33(XB2-EG33) NO+NO 3-position locked            LAY5-EG41(XB2-EG41) NO+NC 2-position reset            LAY5-EG45(XB2-EG45) NO+NC 2-position reset            LAY5-EG53(XB2-EG53) NO+NO 3-position reset</p>	 

	<p><b>Even button spring return</b></p> <table border="0"> <tr><td>LAYS-EC21(XB2-EC21)</td><td>40</td><td>NO</td></tr> <tr><td>LAYS-EC31(XB2-EC31)</td><td>40</td><td>NO</td></tr> <tr><td>LAYS-EC42(XB2-EC42)</td><td>40</td><td>NC</td></tr> <tr><td>LAYS-EC51(XB2-EC51)</td><td>40</td><td>NO</td></tr> <tr><td>LAYS-ER21(XB2-ER21)</td><td>60</td><td>NO</td></tr> <tr><td>LAYS-ER31(XB2-ER31)</td><td>60</td><td>NO</td></tr> <tr><td>LAYS-ER42(XB2-ER42)</td><td>60</td><td>NC</td></tr> <tr><td>LAYS-ER51(XB2-ER51)</td><td>60</td><td>NO</td></tr> </table>	LAYS-EC21(XB2-EC21)	40	NO	LAYS-EC31(XB2-EC31)	40	NO	LAYS-EC42(XB2-EC42)	40	NC	LAYS-EC51(XB2-EC51)	40	NO	LAYS-ER21(XB2-ER21)	60	NO	LAYS-ER31(XB2-ER31)	60	NO	LAYS-ER42(XB2-ER42)	60	NC	LAYS-ER51(XB2-ER51)	60	NO								
LAYS-EC21(XB2-EC21)	40	NO																															
LAYS-EC31(XB2-EC31)	40	NO																															
LAYS-EC42(XB2-EC42)	40	NC																															
LAYS-EC51(XB2-EC51)	40	NO																															
LAYS-ER21(XB2-ER21)	60	NO																															
LAYS-ER31(XB2-ER31)	60	NO																															
LAYS-ER42(XB2-ER42)	60	NC																															
LAYS-ER51(XB2-ER51)	60	NO																															
	<p><b>Even button spring return With symbol logo</b></p> <table border="0"> <tr><td>LAYS-ES442(XB2-ES442)</td><td>30</td><td>NC</td></tr> <tr><td>LAYS-ES542(XB2-ES542)</td><td>40</td><td>NC</td></tr> <tr><td>LAYS-ES642(XB2-ES642)</td><td>60</td><td>NC</td></tr> </table>	LAYS-ES442(XB2-ES442)	30	NC	LAYS-ES542(XB2-ES542)	40	NC	LAYS-ES642(XB2-ES642)	60	NC																							
LAYS-ES442(XB2-ES442)	30	NC																															
LAYS-ES542(XB2-ES542)	40	NC																															
LAYS-ES642(XB2-ES642)	60	NC																															
	<p><b>Button with protective cover</b></p> <table border="0"> <tr><td>LAYS-ET42(XB2-ET42)</td><td>40</td><td>NC</td></tr> <tr><td>LAYS-ET845(XB2-ET845)</td><td>40</td><td>NO+NC</td></tr> </table>	LAYS-ET42(XB2-ET42)	40	NC	LAYS-ET845(XB2-ET845)	40	NO+NC																										
LAYS-ET42(XB2-ET42)	40	NC																															
LAYS-ET845(XB2-ET845)	40	NO+NC																															
	<p><b>Protruding button</b></p> <table border="0"> <tr><td>LAYS-ES142(XB2-ES142)</td><td>40</td><td>NC</td></tr> <tr><td>LAYS-ES8445(XB2-ES8445)</td><td>40</td><td>NO+NC</td></tr> </table>	LAYS-ES142(XB2-ES142)	40	NC	LAYS-ES8445(XB2-ES8445)	40	NO+NC																										
LAYS-ES142(XB2-ES142)	40	NC																															
LAYS-ES8445(XB2-ES8445)	40	NO+NC																															
	<p><b>Protruding button spring return With symbol logo</b></p> <table border="0"> <tr><td>LAYS-EL8325(XB2-EL8325)</td><td></td><td>NO+NC</td></tr> <tr><td>LAYS-EL8425(XB2-EL8425)</td><td></td><td>NO+NC</td></tr> </table>	LAYS-EL8325(XB2-EL8325)		NO+NC	LAYS-EL8425(XB2-EL8425)		NO+NC																										
LAYS-EL8325(XB2-EL8325)		NO+NC																															
LAYS-EL8425(XB2-EL8425)		NO+NC																															
	<p><b>Standard handle knob</b></p> <table border="0"> <tr><td>LAYS-EW8365(XB2-EW8365)</td><td>NO+NC</td><td>Directness</td></tr> <tr><td>LAYS-EW8465(XB2-EW8465)</td><td>NO+NC</td><td>Directness</td></tr> <tr><td>LAYS-EW8375(XB2-EW8375)</td><td>NO+NC</td><td>Resistance</td></tr> <tr><td>LAYS-EW8475(XB2-EW8475)</td><td>NO+NC</td><td>Resistance</td></tr> </table>	LAYS-EW8365(XB2-EW8365)	NO+NC	Directness	LAYS-EW8465(XB2-EW8465)	NO+NC	Directness	LAYS-EW8375(XB2-EW8375)	NO+NC	Resistance	LAYS-EW8475(XB2-EW8475)	NO+NC	Resistance																				
LAYS-EW8365(XB2-EW8365)	NO+NC	Directness																															
LAYS-EW8465(XB2-EW8465)	NO+NC	Directness																															
LAYS-EW8375(XB2-EW8375)	NO+NC	Resistance																															
LAYS-EW8475(XB2-EW8475)	NO+NC	Resistance																															
	<p><b>Long handle knob</b></p> <table border="0"> <tr><td>LAYS-EV61(XB2-EV61)</td><td>Directness</td><td></td></tr> <tr><td>LAYS-EV63(XB2-EV63)</td><td>Directness</td><td></td></tr> <tr><td>LAYS-EV64(XB2-EV64)</td><td>Directness</td><td></td></tr> <tr><td>LAYS-EV65(XB2-EV65)</td><td>Directness</td><td></td></tr> <tr><td>LAYS-EV66(XB2-EV66)</td><td>Directness</td><td>220V</td></tr> <tr><td>LAYS-EV71(XB2-EV71)</td><td>Resistance</td><td>6-380V</td></tr> <tr><td>LAYS-EV73(XB2-EV73)</td><td>Resistance</td><td></td></tr> <tr><td>LAYS-EV74(XB2-EV74)</td><td>Resistance</td><td></td></tr> <tr><td>LAYS-EV75(XB2-EV75)</td><td>Resistance</td><td></td></tr> <tr><td>LAYS-EV76(XB2-EV76)</td><td>Resistance</td><td></td></tr> </table>	LAYS-EV61(XB2-EV61)	Directness		LAYS-EV63(XB2-EV63)	Directness		LAYS-EV64(XB2-EV64)	Directness		LAYS-EV65(XB2-EV65)	Directness		LAYS-EV66(XB2-EV66)	Directness	220V	LAYS-EV71(XB2-EV71)	Resistance	6-380V	LAYS-EV73(XB2-EV73)	Resistance		LAYS-EV74(XB2-EV74)	Resistance		LAYS-EV75(XB2-EV75)	Resistance		LAYS-EV76(XB2-EV76)	Resistance			
LAYS-EV61(XB2-EV61)	Directness																																
LAYS-EV63(XB2-EV63)	Directness																																
LAYS-EV64(XB2-EV64)	Directness																																
LAYS-EV65(XB2-EV65)	Directness																																
LAYS-EV66(XB2-EV66)	Directness	220V																															
LAYS-EV71(XB2-EV71)	Resistance	6-380V																															
LAYS-EV73(XB2-EV73)	Resistance																																
LAYS-EV74(XB2-EV74)	Resistance																																
LAYS-EV75(XB2-EV75)	Resistance																																
LAYS-EV76(XB2-EV76)	Resistance																																
	<p><b>Key button</b></p> <table border="0"> <tr><td>LAYS-EW3161(XB2-EW3161)</td><td>NO</td><td></td></tr> <tr><td>LAYS-EW3361(XB2-EW3361)</td><td>NO</td><td></td></tr> <tr><td>LAYS-EW3462(XB2-EW3462)</td><td>NC</td><td>Directness</td></tr> <tr><td>LAYS-EW3561(XB2-EW3561)</td><td>NO</td><td>220V-240V</td></tr> <tr><td>LAYS-EW3661(XB2-EW3661)</td><td>NO</td><td></td></tr> </table>	LAYS-EW3161(XB2-EW3161)	NO		LAYS-EW3361(XB2-EW3361)	NO		LAYS-EW3462(XB2-EW3462)	NC	Directness	LAYS-EW3561(XB2-EW3561)	NO	220V-240V	LAYS-EW3661(XB2-EW3661)	NO																		
LAYS-EW3161(XB2-EW3161)	NO																																
LAYS-EW3361(XB2-EW3361)	NO																																
LAYS-EW3462(XB2-EW3462)	NC	Directness																															
LAYS-EW3561(XB2-EW3561)	NO	220V-240V																															
LAYS-EW3661(XB2-EW3661)	NO																																

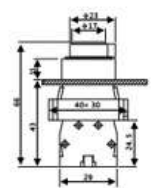
# Push Button XB2 Series

	<p><b>Even button spring return</b></p> <p>LAY5-BA11(XB2-BA11)                      LAY5-BA21(XB2-BA21)                      LAY5-BA31(XB2-BA31)                      LAY5-BA42(XB2-BA42)                      LAY5-BA51(XB2-BA51)                      LAY5-BA61(XB2-BA61)                      LAY5-BA25(XB2-BA25)                      LAY5-BA35(XB2-BA35)                      LAY5-BA45(XB2-BA45)</p> <p>NO NO NO NC NO NO NO+NC NO+NC NO+NC</p>	 
	<p><b>Even button spring return With symbol logo</b></p> <p>LAY5-BA3311(XB2-BA3311)                      LAY5-BA3361(XB2-BA3361)                      LAY5-BA3341(XB2-BA3341)                      LAY5-BA3351(XB2-BA3351)                      LAY5-BA4322(XB2-BA4322)                      LAY5-BA4342(XB2-BA4342)                      LAY5-BA5331(XB2-BA5331)                      LAY5-BA5321(XB2-BA5321)</p> <p>NO I NO II NO  NO  NC  NC STOP NO START NO START</p>	 
	<p><b>Button with protective cover</b></p> <p>LAY5-BP11(XB2-BP11)                      LAY5-BP21(XB2-BP21)                      LAY5-BP31(XB2-BP31)                      LAY5-BP42(XB2-BP42)                      LAY5-BP51(XB2-BP51)                      LAY5-BP61(XB2-BP61)</p> <p>NO NO NO NC NO NO</p> <p>Ip65</p>	 
	<p><b>Protruding button</b></p> <p>LAY5-BL21(XB2-BL21)                      LAY5-BL31(XB2-BL31)                      LAY5-BL42(XB2-BL42)                      LAY5-BL51(XB2-BL51)                      LAY5-BL61(XB2-BL61)</p> <p>NO NC NO NO NO</p>	 
	<p><b>Protruding button spring return With symbol logo</b></p> <p>LAY5-BL3311(XB2-BL3311)                      LAY5-BL3361(XB2-BL3361)                      LAY5-BL3341(XB2-BL3341)                      LAY5-BL3341(XB2-BL3341)                      LAY5-BL4322(XB2-BL4322)                      LAY5-BL4342(XB2-BL4342)</p> <p>NO I NO II NO  NO  NC  NC STOP</p>	 
	<p><b>Standard handle knob</b></p> <p>LAY5-BD21(XB2-BD21)                      LAY5-BD25(XB2-BD25)                      LAY5-BD33(XB2-BD33)                      LAY5-BD41(XB2-BD41)                      LAY5-BD45(XB2-BD45)                      LAY5-BD53(XB2-BD53)</p> <p>NO 2-position locked                      NO+NC 3-position locked                      NO+NO 2-position locked                      NO 2-position reset                      NO 2-position reset                       NO+NO 3-position reset </p>	 
	<p><b>Long handle knob</b></p> <p>LAY5-BJ21(XB2-BJ21)                      LAY5-BJ25(XB2-BJ25)                      LAY5-BJ33(XB2-BJ33)                      LAY5-BJ41(XB2-BJ41)                      LAY5-BJ45(XB2-BJ45)                      LAY5-BJ53(XB2-BJ53)</p> <p>NO 2-position locked                      NO+NC 3-position locked                      NO+NO 2-position locked                      NO 2-position reset                      NO 2-position reset                       NO+NO 3-position reset </p>	 
	<p><b>Key button</b></p> <p>LAY5-BG21(XB2-BG21)                      LAY5-BG25(XB2-BG25)                      LAY5-BG03(XB2-BG03)                      LAY5-BG33(XB2-BG33)                      LAY5-BG41(XB2-BG41)                      LAY5-BG45(XB2-BG45)                      LAY5-BG53(XB2-BG53)</p> <p>NO 2-position locked                       NO+NC 2-position locked                       NO+NO 3-position locked                       NO+NO 3-position locked                       NO+NC 2-position reset                       NO+NC 2-position reset                       NO+NO 3-position reset </p>	 



# CES-Cable Entry Systems



CESS-Cable Entry Systems





LKP/N 24/11



LKP/N 24/12



LKP/N 24/13



LKP/N 24/14



LKP/N 24/17



LKP/N 24/17-1



LKP/N 24/22



LKP/N 24/22-1



LKP/N 24/23



LKP/N 24/29



LKP/N 24/29-1



LKP/N 24/80

**Advantage**

- Save space
- Protection grade IP65
- Built-in seal structure
- One wear mode
- The possibility of a cable identity with a cable

**Material Science**

- Material: improved nylon
- Temperature range: -30~+70°C
- Protection grade: IP65
- Flame retardancy (UL 94): V0

- Color: gray, black
- Aperture size: 36x112mm
- Product thickness: 14mm
- Harmful ingredients: halogen free

**Technical parameter**

- External dimensions: L=147mmx8=59mmx15mm
- The tensile properties conform to DIN/EN 50262/98
- Weak acid and weak base

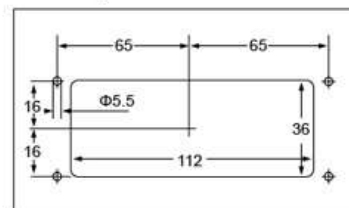
**Size diagram**

Type	corresponds to cable diameter(mm)									Order No.	Number of lines
	1.5-2.6	2.5-5.0	3.0-6.5	4.1-8.1	5.0-9.2	8.0-12.5	9.0-14.0	9.6-15.9	14.0-20.0		
LKP/N 24/11	--	--	4	--	4	--	--	--	3	600011	11
LKP/N 24/12	--	--	--	--	--	12	--	--	--	600012	12
LKP/N 24/13	--	--	2	6	--	--	4	--	1	600013	13
LKP/N 24/14	--	--	6	--	4	--	--	4	--	600014	14
LKP/N 24/17	--	--	--	--	17	--	--	--	--	600017	17
LKP/N 24/17-1	--	--	11	1	--	5	--	--	--	600171	17
LKP/N 24/22	--	--	15	--	6	--	--	--	1	600022	22
LKP/N 24/22-1	--	--	16	--	4	2	--	--	--	600221	22
LKP/N 24/23	--	--	--	23	--	--	--	--	--	600023	23
LKP/N 24/29	--	--	29	--	--	--	--	--	--	600029	29
LKP/N 24/29-1	--	--	26	--	3	--	--	--	--	600291	29
LKP/N 24/80	78	2	--	--	--	--	--	--	--	600080	80

## LK Cable fixed frame



LK 去应力固定板可用于减少电缆、绳索或电线的应力，使之合理排布，简化、降低成本。

材质：尼龙

温度范围：-40°C至125°C短时间可至140°C

阻燃性能 (UL 94) : V0

Type	Colour	Order No.	Number of Cables	Type	Colour	Order No.	Number of Cables
LK04	black	600011	12	LK87/50	black	600221	6
LK05	black	600012	15	LK103	black	600023	7
LK39	black	600013	3	LK121	black	600029	8
LK60	black	600014	4	LK140	black	600291	9
LK70	black	600017	5	LK180/6	black	600080	12
LK80	black	600171	6	LK180/8	black	600080	12
LK87/68	black	600022	6				

## LK-KAF Cable fixed frame



LK-KAF 是在标准LK产品上增加C轨或HAT轨卡口，安装简易迅速，无需螺钉固定。

适用：35mm HAT轨 (EN 50022；Niedax 2934；2936) 或C轨 (Niedax2970；2971)

材质：尼龙

温度范围：-40°C至125°C短时间可至140°C

阻燃性能 (UL 94) : V0

Type	Colour	Order No.	Number of Cables
LK-KAF11	black	600011	1
LK-KAF75	black	600012	5
LK-KAF140	black	600013	9

## LK-MH Cable fixed frame

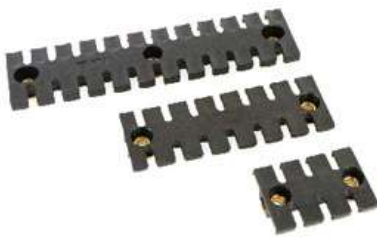

MH 是在标准LK产品上加装金属垫圈，以增强固定强度。

材质：尼龙

温度范围：-40°C至125°C短时间可至140°C

阻燃性能 (UL 94) : V0

Type	Colour	Order No.	Number of Cables	Type	Colour	Order No.	Number of Cables
LK-MH39	black	600011	3	LK-MH39/6	black	600221	3
LK-MH60	black	600012	4	LK-MH60/6	black	600023	4
LK-MH87	black	600013	6	LK-MH70/6	black	600029	5
LK-MH103	black	600014	7	LK-MH87/6	black	600291	6
LK-MH121	black	600017	8	LK-MH103/6	black	600080	7
LK-MH140	black	600171	9	LK-MH121/6	black	600080	8
LK-MH180	black	600022	12	LK-MH140/6	black	600080	9
				LK-MH180/6	black	600080	12

## LK-SW Cable fixed frame



SW 是在标准LK产品上加装可直接固定在C轨道上的金属固定装置，被专用在机车行业。

材质：尼龙

温度范围：-40°C至125°C短时间可至140°C

阻燃性能 (UL 94) : V0

Type	Colour	Order No.	Number of Cables
LK-SW39	black	600011	3
LK-SW60	black	600012	4
LK-SW87	black	600013	6
LK-SW103	black	600014	7
LK-SW121	black	600017	8
LK-SW140	black	600171	9
LK-SW180/6	black	600022	12



Frame Height: 17mm

### CES 6 Standard cable entry frame

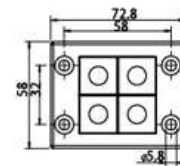
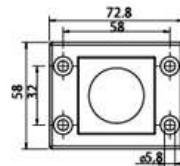

Material: Nylon 66, halogen free  
 Color: Black  
 Temperature: -40°C-140°C  
 Protection level: IP54/IP65 (with gasket and correct selection of the cable inserts )  
 Flame Class: UL94: V0  
 Cut-out dimensions: 46x46mm

Type	Inserts Small/large	Order No.	PU
CES6/1	Insert Medium	600101	5
CES6/4	Insert Small	600102	5

### CES 10 Standard cable entry frame

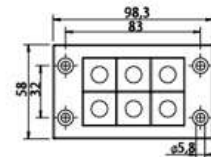
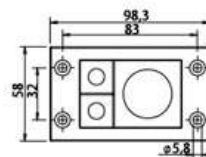

Material: Nylon 66, halogen free  
 Color: Black  
 Temperature: -40°C-140°C  
 Protection level: IP54/IP65 (with gasket and correct selection of the cable inserts )  
 Flame Class: UL94: V0  
 Cut-out dimensions: 36x65mm

Type	Inserts Small/large	Order No.	PU
CES10/3	Insert Medium/Insert small	600103	5
CES10/6	Insert Small	600104	5

## CES 16 Standard cable entry frame



Material: Nylon 66, halogen free  
 Color: Black  
 Temperature: -40°C-140°C  
 Protection level: IP54/IP65 (with gasket and correct selection of the cable inserts )  
 Flame Class: UL94: V0  
 Cut-out dimensions: 36x86mm

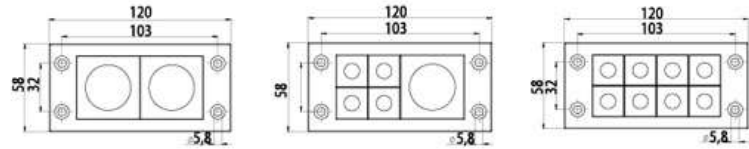

Type	Inserts Small/large	Order No.	PU
CES 16/2	Insert Medium	600105	5
CES 16/5	Insert Medium/Insert Small	600106	5
CES 16/8	Insert Small	600107	5

## CES 24 Standard cable entry frame



Material: Nylon 66, halogen free  
 Color: Black  
 Temperature: -40°C-140°C  
 Protection level: IP54/IP65 (with gasket and correct selection of the cable inserts )  
 Flame Class: UL94: V0  
 Cut-out dimensions: 36x112mm

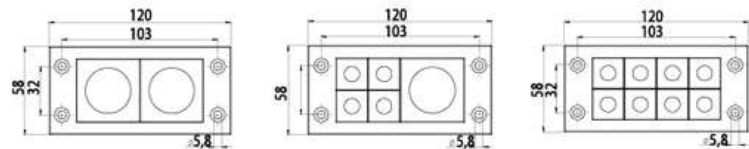

Type	Inserts Small/large	Order No.	PU
CES 24/4	Insert Medium/Insert Small	600108	5
CES 24/7	Insert Medium/Insert Small	600109	5
CES 24/10	Insert Small	600110	5

## CES standard snap frame



Material: Nylon 66, halogen free  
 Color: Black  
 Temperature: -40°C-140°C  
 Protection level: IP54/IP65 (with gasket and correct selection of the cable inserts )  
 Flame Class: UL94: V0

Used to assemble CES6,10,16,24 series frame, connected with cabinet with screw bolts

Type	Order No.	PU
CES SNAP6	600111	5
CES SNAP10	600112	5
CES SNAP16	600113	5
CES SNAP24	600114	5

## Standard cable entry frame with brush



Material  
 Frame: polyamide (nylon)  
 Brush: polyamide (nylon)  
 temperature -20°C-90°C Halogen free, silicon free  
 Height: 10mm

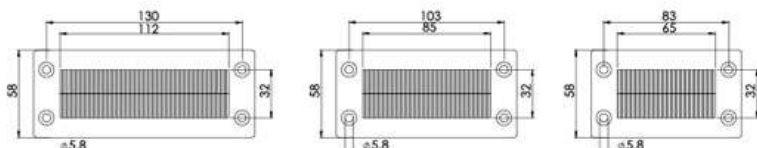

Type	Cut-out dimensions	Order No.	PU
CES BES/24	36x112mm	600431	5
CES BES/16	36x86mm	600432	5
CES BES/10	36x65mm	600433	5

## brush

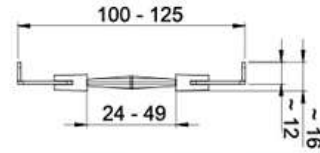
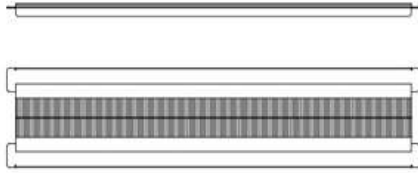

Type	Control cabinet length	Brush Length	Drilling Length	Order No.	PU
CES-BES-TS8-600	600	458mm	436mm	600434	5
CES-BES-TS8-800	800	658mm	636mm	600435	5
CES-BES-TS8-1000	1000	858mm	836mm	600436	5

## Single row cable entry frame

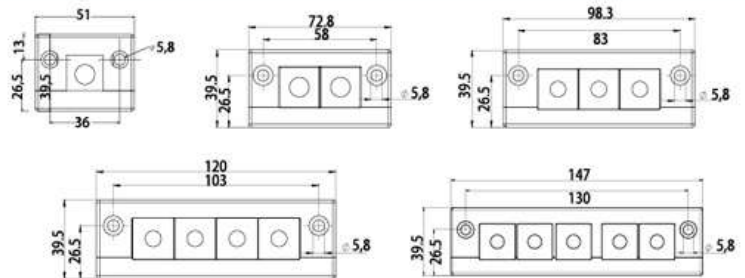

Material: Nylon 66, halogen free  
 Color: Black  
 Temperature: -40°C-140°C  
 Protection level: IP54/IP65 (with gasket and correct selection of the cable inserts )  
 Flame Class: UL94: V0  
 Cut-out dimensions: E1: 24x24mm E2: 43x24mm  
 E3: 65x24mm E4: 86x24mm E5: 112x24mm

Type	Inserts Small/large	Order No.	PU
CES E1	Insert Small	600437	5
CES E2	Insert Small	600115	5
CES E3	Insert Small	600116	5
CES E4	Insert Small	600117	5
CES E5	Insert Small	600118	5

## CES ED double row cable entry frame

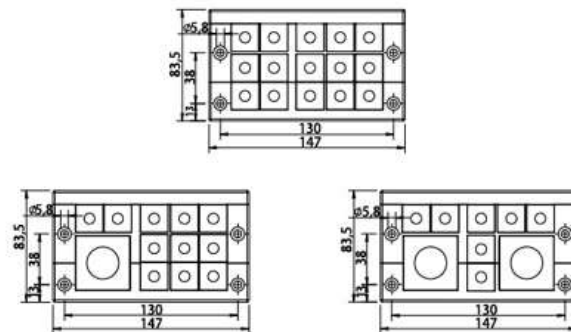

Material  
 Frame: polyamide (nylon)  
 Brush: polyamide (nylon)  
 temperature -20°C-90°C Halogen free, silicon free  
 Cut-out dimensions: 62x112mm

Type	Inserts Small/large	Order No.	PU
CES 24/15-ED	Insert small	600119	5
CES 24/12-ED	Insert Medium/Insert Small	600120	5
CES 24/9-ED	Insert Medium/Insert Small	600121	5

## CES ET double row cable entry frame



Material: Nylon 66, halogen free  
 Color: Black  
 Temperature: -40°C-140°C  
 Protection level: IP54/IP65 (with gasket and correct selection of the cable inserts )  
 Flame Class: UL94: V0  
 Cut-out dimensions: 82x112mm

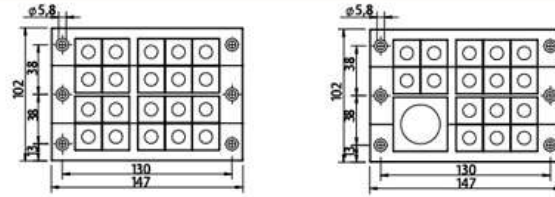

Type	Inserts Small/large	Order No.	PU
CES 24/20-ET	Insert Small	600122	5
CES 24/17-ET	Insert Medium/Insert Small	600123	5

## CES ET double row cable entry frame



Material: Nylon 66, halogen free  
 Color: Black  
 Temperature: -40°C-140°C  
 Protection level: IP54/IP65 (with gasket and correct selection of the cable inserts )  
 Flame Class: UL94: V0  
 Cut-out dimensions: 82x112mm

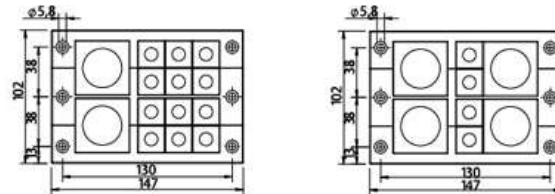

Type	Inserts Small/large	Order No.	PU
CES 24/14-ET	Insert Medium/Insert Small	600124	5
CES 24/8-ET	Insert Medium/Insert Small	600125	5

## CES ET double row cable entry frame



Material: Nylon 66, halogen free  
 Color: Black  
 Temperature: -40°C-140°C  
 Protection level: IP54/IP65 (with gasket and correct selection of the cable inserts )  
 Flame Class: UL94: V0  
 Cut-out dimensions: 82x86mm

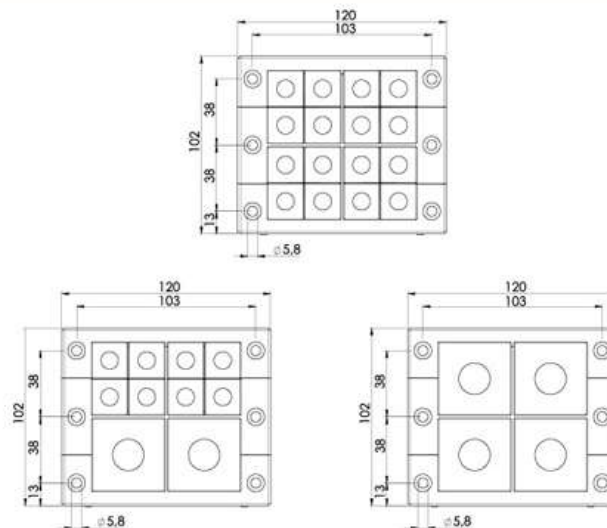

Type	Inserts Small/large	Order No.	PU
CES 16/16-ET	Insert Small	600438	5
CES 16/10-ET	Insert Medium/Insert Small	600439	5
CES 16/4-ET	Insert Medium	600440	5

## CES ET Triple row cable entry frame



Material: Nylon 66, halogen free  
 Color: Black  
 Temperature: -40°C-140°C  
 Protection level: IP54/IP65 (with gasket and correct selection of the cable inserts )  
 Flame Class: UL94: V0  
 Cut-out dimensions: 126x86mm

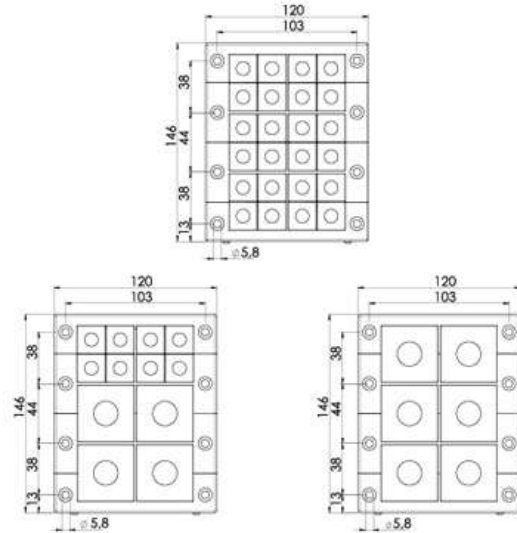

Type	Inserts Small/large	Order No.	PU
CES 16/24-2ET	Insert Small	600441	5
CES 16/12-2ET	Insert Medium/Insert Small	600442	5
CES 16/6-2ET	Insert Medium	600443	5

## CES 2ET triple row cable entry frame



Material: Nylon 66, halogen free  
 Color: Black  
 Temperature: -40°C-140°C  
 Protection level: IP54/IP65 (with gasket and correct selection of the cable inserts )  
 Flame Class: UL94: V0  
 Cut-out dimensions: 126x112mm

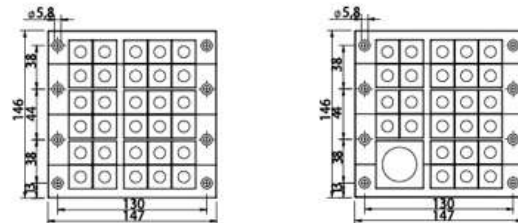

Type	Inserts Small/large	Order No.	PU
CES 24/30-2ET	Insert small	600126	5
CES 24/27-2ET	Insert Medium/Insert small	600127	5

## CES 2ET triple row cable entry frame

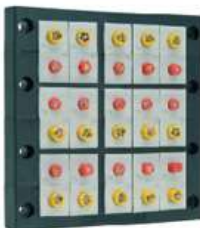

Material: Nylon 66, halogen free  
 Color: Black  
 Temperature: -40°C-140°C  
 Protection level: IP54/IP65 (with gasket and correct selection of the cable inserts )  
 Flame Class: UL94: V0  
 Cut-out dimensions: 126x112mm

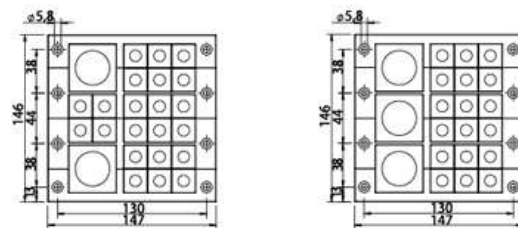

Type	Inserts Small/large	Order No.	PU
CES 24/24-2ET	Insert Medium/Insert small	600128	5
CES 24/21-2ET	Insert Medium/Insert small	600129	5

## CES 2ET triple row cable entry frame



Material: Nylon 66, halogen free  
 Color: Black  
 Temperature: -40°C-140°C  
 Protection level: IP54/IP65 (with gasket and correct selection of the cable inserts )  
 Flame Class: UL94: V0  
 Cut-out dimensions: 126x112mm

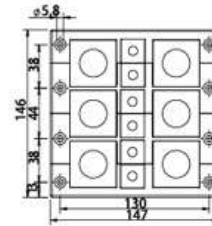

Type	Inserts Small/large	Order No.	PU
CES 24/12-2ET	Insert Medium/Insert Small	600130	5

Frame Height: 35mm

## CES 64 Cable entry frame for large conductor



Material: Nylon 66, halogen free  
 Color: Black  
 Temperature: -40°C-140°C  
 Protection level: IP54/IP65 (with gasket and correct selection of the cable inserts )  
 Flame Class: UL94: V0  
 Cut-out dimensions: Cable diameter+15-50%  
 Thickness: 34.5mm

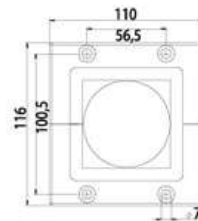

Type	Inserts Small/large	Order No.	PU
CES 64/1	Insert large	6004501	5

## CES 64 Cable entry frame for large conductor



Material: Nylon 66, halogen free  
 Color: Black  
 Temperature: -40°C-140°C  
 Protection level: IP54/IP65 (with gasket and correct selection of the cable inserts )  
 Flame Class: UL94: V0  
 Cut-out dimensions: Cable diameter+15-50%  
 Thickness: 34.5mm

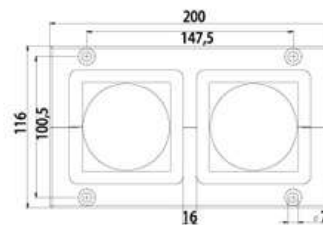

Type	Inserts Small/large	Order No.	PU
CES 64/2	Insert large	6004502	5

## Cable inserts for large Conductor



Inserts for large conductor X: 34-74mm

Material: TPE, halogen free  
 Color: Grey, Black  
 Temperature: -40°C-140°C  
 Protection level: IP54/IP65 (with gasket and correct selection of the cable inserts )  
 Flame Class: UL94:V2, V0(Customized)

Type	Order No.(Grey)	Order No.(Black)	PU
CES X-(X+1)	60045X	60145X	5

Frame Height: 17mm

## CES NL Cable entry frame for flat conductor



Material: Nylon 66, halogen free  
 Color: Black  
 Temperature: -40°C-140°C  
 Protection level: IP54/IP65 (with gasket and correct selection of the cable inserts )  
 Flame Class: UL94: V0  
 Cut-out dimensions: 24x24mm 43x24mm 65x24mm

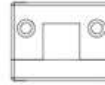

CES NL/M



CES NL/B (0xPT/1xNT-2)



CES NL/A (0xPT/1xNT-1)

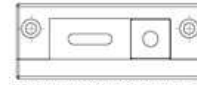

CES NL/C (1xPT/1xNT-1)

Type	Order No.	PU
CES NL/M	600444	5
CES NL/A (0xPT/1xNT-1)	600133	5
CES NL/B (0xPT/1xNT-2)	600134	5
CES NL/C (1xPT/1xNT-1)	600135	5

## CES NL Cable entry frame for flat conductor



Material: Nylon 66, halogen free  
 Color: Black  
 Temperature: -40°C-140°C  
 Protection level: IP54/IP65 (with gasket and correct selection of the cable inserts )  
 Flame Class: UL94: V0  
 Cut-out dimensions: 86x24mm



CES NL/D (0xPT/1xNT-3)



CES NL/F (0xPT/2xNT-1)



CES NL/E (1xPT/1xNT-2)



CES NL/G (2xPT/1xNT-1)

Type	Order No.	PU
CES NL/D (0xPT/1xNT-3)	600136	5
CES NL/E (1xPT/1xNT-2)	600137	5
CES NL/F (0xPT/2xNT-1)	600138	5
CES NL/G (2xPT/1xNT-1)	600139	5

## CES NL Cable entry frame for flat conductor



Material: Nylon 66, halogen free  
 Color: Black  
 Temperature: -40°C-140°C  
 Protection level: IP54/IP65 (with gasket and correct selection of the cable inserts )  
 Flame Class: UL94: V0  
 Cut-out dimensions: 112x24mm

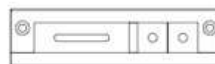

CES NL/H (2xPT/1xNT-2)



CES NL/J (3xPT/1xNT-1)



CES NL/I (1xPT/2xNT-1)



CES NL/K (1xNT-1/1xNT-2)



CES NL/L (1xNT-4)

Type	Order No.	PU
CES NL/H (2xPT/1xNT-2)	600140	5
CES NL/I (1xPT/2xNT-1)	600141	5
CES NL/J (3xPT/1xNT-1)	600142	5
CES NL/K (1xNT-1/1xNT-2)	600143	5
CES NL/L (1xNT-4)	600144	5

## Inserts for flat cables



Material: TPE, halogen free  
 Color: Light Grey  
 Temperature: -40°C-140°C  
 Protection level: IP54  
 Flame Class: UL94: V0

Type	Clamping range	Order No.	PU
E1	adapter inserts	600445	5
FT-1/0	Blind Inserts	600446	5
FT-1/A	Width: 19.0-23.0mm Thickness5.5-6.0mm	600447	5
FT-1/B	Width: 28.0-33.0mm Thickness5.5-6.0mm	600448	5
FT-1/C	Width: 24.0-30.0mm Thickness8.5-9.0mm	600449	5
FT-1/F	Width: 28.0-33.0mm Thickness9.0-9.5mm	600450	5
FT-2/0	Blind Inserts	600451	5
FT-2/A	Width: 32.5-38.0mm Thickness5.0-5.5mm	600452	5
FT-2/B	Width: 45.0-50.5mm Thickness6.0-6.5mm	600453	5
FT-2/C	Width: 47.0-52.0mm Thickness9.5-10.0mm	600454	5
FT-3/0	Blind Inserts	600455	5
FT-3/A	Width: 72.0-77.0mm Thickness5.0-5.5mm	600456	5
FT-4/A	Width: 85.0-99.0mm Thickness4.2-5.2mm	600457	5
FT-4/0	Blind Inserts	600458	5

## CES NG bowled angle cable entry frame



Material: Nylon 66, halogen free  
 Color: Black  
 Temperature: -40°C-140°C  
 Protection level: IP54/IP65 (with gasket and correct selection of the cable inserts )  
 Flame Class: UL94: V0  
 Cut-out dimensions: 36x112mm

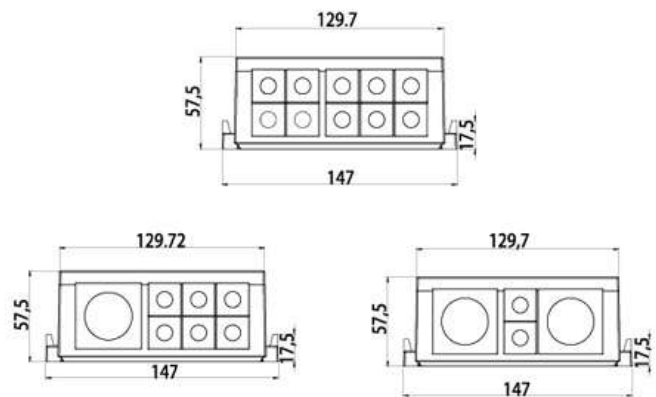

Type	Inserts Small/large	Order No.	PU
CES NG A10	Insert Small	600145	5
CES NG A7	Insert Medium/Insert Small	600146	5
CES NG A4	Insert Medium/Insert Small	600147	5

## CES NG bowled angle cable entry frame

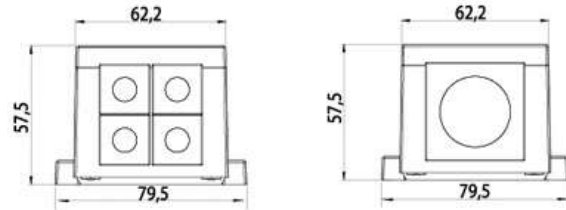

Material: Nylon 66, halogen free  
 Color: Black  
 Temperature: -40°C-140°C  
 Protection level: IP54/IP65 (with gasket and correct selection of the cable inserts )  
 Flame Class: UL94: V0  
 Cut-out dimensions: 46x36mm

Type	Inserts Small/large	Order No.	PU
CES NG B4	Insert Small	600148	5
CES NG B1	Insert Medium	600149	5

## CES KPF conical cable seal



Material: TPE, halogen free  
 Color: Light Grey  
 Temperature: -40°C-140°C  
 Protection level: IP54/IP65 (with gasket and correct selection of the cable inserts )  
 Flame Class: UL94: V0

Type	Bottom External Diameter	Order No.	PU
CES KPF/M25/3-17	39mm	600163	5
CES KPF/M32/6-24	46mm	600164	5
CES KPF/M40/11-32	54mm	600165	5
CES KPF/M50/17-42	64mm	600166	5
CES KPF/M63/23-55	77mm	600167	5

## CES DPF conical cable seal

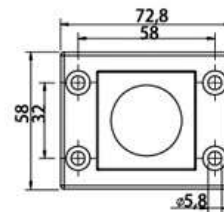

Material: TPE, Nylon 66, halogen free  
 Color: Light Grey  
 Temperature: -40°C-140°C  
 Protection level: IP54/IP65 (with gasket and correct selection of the cable inserts )  
 Flame Class: UL94: V0

Type	Order No.	PU
CES DPF-C-SET	600168	5

## CES DPF conical cable seal

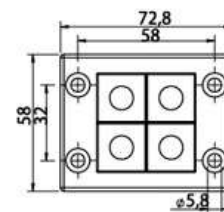

Material: TPE, Nylon 66, halogen free  
 Color: Light Grey  
 Temperature: -40°C-140°C  
 Protection level: IP54/IP65 (with gasket and correct selection of the cable inserts )  
 Flame Class: UL94: V0

Type	Order No.	PU
CES DPF-4A-SET	600169	5

## Accessories



Type	product description	Order No.	PU
CES BP 6		600181	5
CES BP 10		600182	5
CES BP 16	Blind plate (Zinc-plated steel)	600183	5
CES BP 24		600184	5
RH 800449		600459	5

## CES RVT Split cable glands

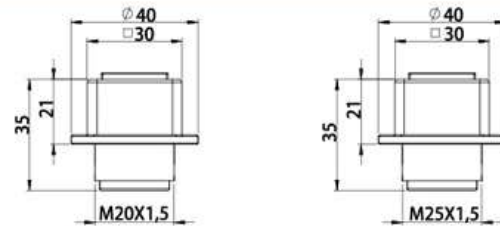

Material: Poly carbonate (PC), halogen free  
 Color: Light Grey, Black  
 Temperature: -30°C-100°C  
 Protection level: IP54/IP65 (with gasket and correct selection of the cable inserts )  
 Flame Class: UL94: V0

Type	Inserts Small/large	Order No.	PU
CES RVT/M20	Insert Small	600158	5
CES RVT/M25	Insert Small	600159	5

## CES RVT Split cable glands

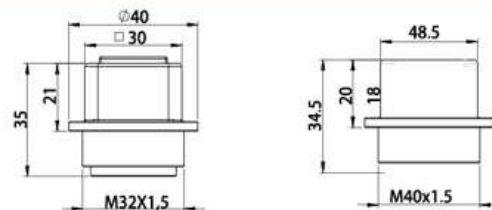

Material: Poly carbonate (PC), halogen free  
 Color: Light Grey, Black  
 Temperature: -30°C-100°C  
 Protection level: IP54/IP65 (with gasket and correct selection of the cable inserts )  
 Flame Class: UL94: V0

Type	Inserts Small/large	Order No.	PU
CES RVT/M32	Insert Small	600160	5
CES RVT/M40/2	Insert Small	600161	5

## CES RVT Split cable glands

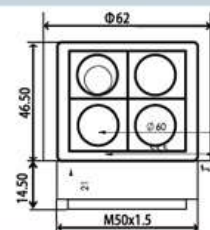

Material: Poly carbonate (PC), halogen free  
 Color: Light Grey, Black  
 Temperature: -30°C-100°C  
 Protection level: IP54/IP65 (with gasket and correct selection of the cable inserts )  
 Flame Class: UL94: V0

Type	Inserts Small/large	Order No.	PU
CES RVT/M50/4	Insert Small	600162	5
CES RVT/M50/1	Insert Medium	600164	5

## KVT 80 Split Cable Glands

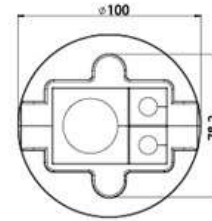

Material: Poly carbonate (PC) screw : stainless steel  
 Color: Grey Temperature: -30°C-100°C ( static)  
 Properties: Halogen-free, silicone-free  
 Protection level: IP54 (with gasket and correct selection of the cable inserts )  
 Flame Class: UL94: V0 ,self-extinguishing  
 Cut-out dimension: 80mm in diameter

Type	Inserts Small/large	Order No.	PU
CES RVT 80/3	Insert Medium/Insert Small	600465	1

## KVT 80 Split Cable Glands

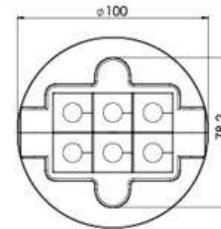
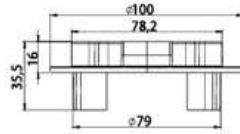

Material: Poly carbonate (PC) screw : stainless steel  
 Color: Grey Temperature: -30°C-100°C ( static)  
 Properties: Halogen-free, silicone-free  
 Protection level: IP54 (with gasket and correct selection of the cable inserts )  
 Flame Class: UL94: V0 ,self-extinguishing  
 Cut-out dimension: 80mm in diameter

Type	Inserts Small/large	Order No.	PU
CES RVT 80/6	Insert Small	600466	1

## CES 90 Split Cable Glands

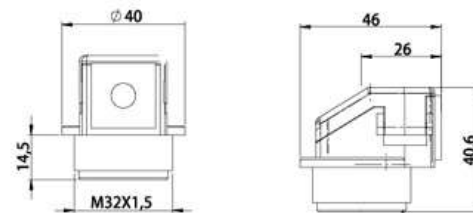

Material: Poly carbonate (PC), halogen free  
 Color: Light Grey,Black  
 Temperature: -30°C-100°C  
 Protection level: IP54/IP65 (with gasket and correct selection of the cable inserts )  
 Flame Class: UL94: V0

Type	Inserts Small/large	Order No.	PU
CES RVT 32-W90	Insert Small	600467	10

## CES 90 Split Cable Glands

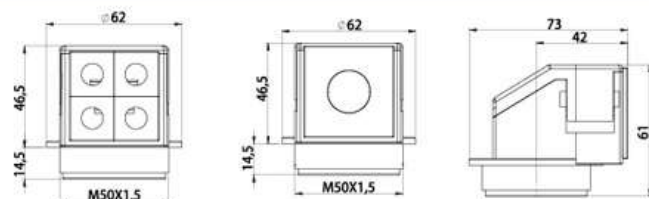

Material: Poly carbonate (PC), halogen free  
 Color: Light Grey,Black  
 Temperature: -30°C-100°C  
 Protection level: IP54/IP65 (with gasket and correct selection of the cable inserts )  
 Flame Class: UL94: V0

Type	Inserts Small/large	Order No.	PU
CES RVT 50/4-W90	Insert Small	600468	10
CES RVT 50/1-W90	Insert Medium	600469	10

## Split locknut



Material: PA6  
 Color: Black  
 Temperature: -30°C-100°C  
 Protection level: IP54  
 Flame Class: UL94: V0

Type	product description	Order No.	PU
CES GMT20	split locknut	600470	10
CES GMT25	split locknut	600471	10
CES GMT32	split locknut	600472	10
CES GMT40	split locknut	600473	10
CES GMT50	split locknut	600474	10

## CES Bulk head fittings



Material: Poly carbonate (PC)  
 Temperature: -30°C-100°C ( static)  
 Properties: Halogen-free, silicone-free  
 Protection level: IP54  
 Flame Class: UL94: V0 ,self-extinguishing

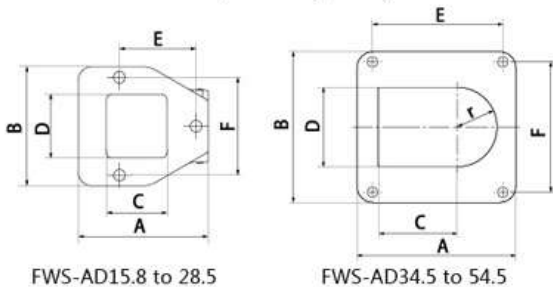

The 90° angled conduit fitting is for installation of parallel corrugated cable protection conduits, for example in machines, control panels or control cabinets. The liftable cover is tightly fixed by a hinge to the mounting box. The system is therefore very easy to handle. CES-FWS will be offered for corrugated conduits with sizes NW 13, 17, 23, 29, 37 and 50.

### CES-FWS Assembly



1. Fix FWS with screws



2. Insert conduit with cables



3. Lock FWS with screws

CES-Cable Entry Systems

Type	Hole $\Phi$ (mm)	Size (mm)	Cut-out (CxD)(mm)	Drill. Templ. (E x F)(mm)	Order No.	PU
CES FWS-AD15.8	3x4.3	49x45	22x26.5	29.0x37.0	600475	10
CES FWS-AD21.2	3x4.3	49x45	22x26.5	29.0x37.0	600476	10
CES FWS-AD28.5	3x4.3	67x63	37x28	41.5x51.5	600477	10
CES FWS-AD34.5	4x6.6	85.5x76	41.9x40 r=20	64.5x64.5	600478	10
CES FWS-AD42.5	4x6.6	97x92	48.3x48.4 r=24.2	79.5x79.5	600479	5
CES FWS-AD54.5	4x6.6	111.5x100.5	53x60.5 r=30.25	87.5x87.5	600480	5

**CES ZD Strain relief plates**

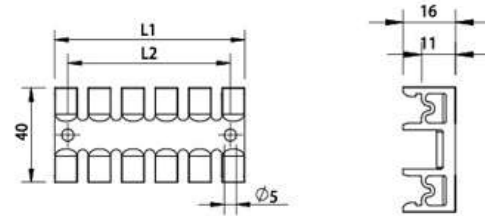

Material: Nylon 66, halogen free  
 Color: Black  
 Temperature: -40°C-140°C  
 Flame Class: UL94: V0



Type	No. of Teeth	Order No.	PU
CES ZD80 (L1: 79, L2: 68)	6	600131	10
CES ZD140 (L1: 139, L2: 128)	9	600132	10

**CES ZL Strain relief plates**

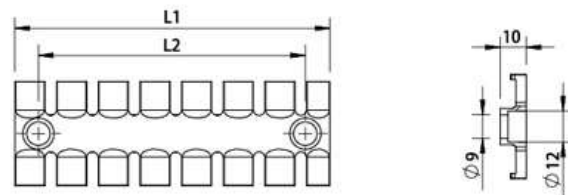
Material: Nylon 66, halogen free  
 Color: Black  
 Temperature: -40°C-140°C  
 Flame Class: UL94: V0

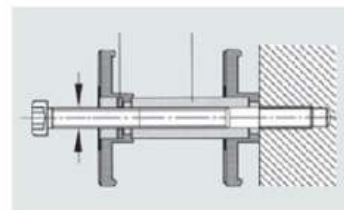

Type	No. of Teeth	Order No.	PU
CES ZL87 (L1: 86.5, L2: 68)	6	600481	10
CES ZL140 (L1: 139.5, L2: 121)	9	600482	10
CES ZL180 (L1: 180, L2: 157)	12	600483	10

**CES DH Distance bushings**

Type	Length	Outside diameter	Order No.	PU
CES DH50	50mm	8mm	322511	10

## SFN NRG Split corrugated conduit



Material: PA6, PE,PP  
 Color: Light Grey, Black, Dark Grey  
 Temperature: PA6: -40°C-115°C  
 PE: -20°C-80°C PP: -40°C-110°C  
 Flame Class: UL94: V2/V0 Customized

Type	Internal/External Diameter(mm)	Order No.	PU
SFN NRG-10.0	6.5x10.0	600499	100
SFN NRG-13.0	10.0x13.0	600500	100
SFN NRG-15.8	12.0x15.8	600501	100
SFN NRG-18.5	14.3x18.5	600502	100
SFN NRG-20.0	16.0x20.0	600503	100
SFN NRG-21.2	17.0x21.2	600504	50
SFN NRG-25.0	21.0x25.0	600505	50
SFN NRG-28.5	23.0x28.5	600506	25
SFN NRG-30.0	25.0x30.0	600507	25
SFN NRG-34.5	29.0x34.5	600508	25
SFN NRG-42.5	36.0x42.5	600509	10
SFN NRG-54.5	48.0x54.5	600510	10
SFN NRG-67.2	56.3x67.2	600511	25
SFN NRG-80.0	66.5x80.0	600512	10
SFN NRG-106.0	91.0x106.0	600513	10

## SFN NRG Standard corrugated conduit



Material: PA6, PE,PP  
 Color: Light Grey, Black, Dark Grey  
 Temperature: PA6: -40°C-115°C  
 PE: -20°C-80°C PP: -40°C-110°C  
 Flame Class: UL94: V2/V0 Customized

Type	Internal/External Diameter(mm)	Order No.	PU
SFN NRG-10.0	6.5x10.0	600484	100
SFN NRG-13.0	10.0x13.0	600485	100
SFN NRG-15.8	12.0x15.8	600486	100
SFN NRG-18.5	14.3x18.5	600487	100
SFN NRG-20.0	16.0x20.0	600488	100
SFN NRG-21.2	17.0x21.2	600489	50
SFN NRG-25.0	21.0x25.0	600490	50
SFN NRG-28.5	23.0x28.5	600491	25
SFN NRG-30.0	25.0x30.0	600492	25
SFN NRG-34.5	29.0x34.5	600493	25
SFN NRG-42.5	36.0x42.5	600494	10
SFN NRG-54.5	48.0x54.5	600495	10
SFN NRG-67.2	56.3x67.2	600496	25
SFN NRG-80.0	66.5x80.0	600497	10
SFN NRG-106.0	91.0x106.0	600498	10

## CES Cable ties with hook-and-loop fastener



Type	Size (mm)			Order No.	PU
	L	B1	B2		
CES LKB 200x7bk	200	13	7	600514	100
CES LKB 200x13bk	200	20	13	600515	100

## CES Cable ties with hook-and-loop fastener



Type	Size (mm)			Order No.	PU
	L	B1	B2		
CES LKB 230x13bk	230	20	13	600516	100
CES LKB 300x17bk	300	25	17	600517	100

## CES Cable ties with hook-and-loop fastener



Material: Polypropylene + Velour PA  
 Color: Black  
 Temperature: -30°C-80°C  
 Flame Class: UL: V0/V2

Type	Size (mm)			Order No.	PU
	L	B1	B2		
CES LB 7bk			7	600518	25
CES LB 10bk			10	600519	25
CES LB 15bk			15	600520	25
CES LB 20bk			20	600521	25
CES LB 25bk			25	600542	25

## CES Holder for hook-and-loop fastener, screwable



Material: Nylon 66, halogen free  
 Color: Black  
 Temperature: -40°C-140°C  
 Flame Class: UL94: V0

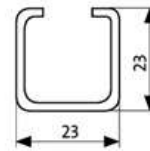
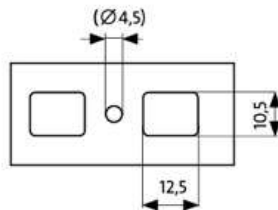

23x23mm Installation Guide



CES BH-R



CES BH-SB

Type	Fit for LKB/LB	Order No.	PU
CES BH-R	LKB 200x7/LKB 200x13/LB 10/LB 15	600522	100
CES BH-SB	LKB 200x7/LB 10	600523	100

## CES Holder for hook-and-loop fastener, assemble and KD by turning 90°



CES BH-RBA

Material: Nylon 66, halogen free  
 Color: Light Grey  
 Temperature: -40°C-140°C  
 Flame Class: UL94: V0  
 Cut-out dimension: Ø6mm



CES BH-RBB

Material: Nylon 66, halogen free  
 Color: Black  
 Temperature: -40°C-140°C  
 Flame Class: UL94: V0  
 Cut-out dimension: Ø6.5mm

Type	Fit for LKB/LB	Order No.	PU
CES BH-RBA	LKB 200x7/LB 10	600525	100
CES BH-RBB	LKB 200x7/LB 10	600526	100

## CES small



Material: TPE halogen free  
 Color: Light Grey, Black  
 Temperature: -40°C-140°C  
 Protection level: IP54  
 Flame Class: UL94: V0

Type	Clamping range mm	Order No.		PU
		Grey	Black	
CES 2	2-3	600302	601302	5
CES 3	3-4	600303	601303	5
CES 4	4-5	600304	601304	5
CES 5	5-6	600305	601305	5
CES 6	6-7	600306	601306	5
CES 7	7-8	600307	601307	5
CES 8	8-9	600308	601308	5
CES 9	9-10	600309	601309	5
CES 10	10-11	600310	601310	5
CES 11	11-12	600311	601311	5
CES 12	12-13	600312	601312	5
CES 13	13-14	600313	601313	5
CES 14	14-15	600314	601314	5
CES 15	15-16	600315	601315	5
CES 16(S)	16-17	600316(S)	601316(S)	5

## CES medium



Material: TPE halogen free  
 Color: Light Grey, Black  
 Temperature: -40°C-140°C  
 Protection level: IP54  
 Flame Class: UL94: V0

Type	Clamping range mm	Order No.		PU
		Grey	Black	
CES 16(M)	16-17	600316(M)	601316(M)	5
CES 17	17-18	600317	601317	5
CES 18	18-19	600318	601318	5
CES 19	19-20	600319	601319	5
CES 20	20-21	600320	601320	5
CES 21	21-22	600321	601321	5
CES 22	22-23	600322	601322	5
CES 23	23-24	600323	601323	5
CES 24	24-25	600324	601324	5
CES 25	25-26	600325	601325	5
CES 26	26-27	600326	601326	5
CES 27	27-28	600327	601327	5
CES 28	28-29	600328	601328	5
CES 29	29-30	600329	601329	5
CES 30	30-31	600330	601330	5
CES 31	31-32	600331	601331	5
CES 32	32-33	600332	601332	5
CES 33	33-34	600333	601333	5

**CES adapter insert(small)**

Material: TPE halogen free  
 Color: Light Grey, Black  
 Temperature: -40°C-140°C  
 Protection level: IP54  
 Flame Class: UL94: V0

Type	Clamping range mm	Order No.		PU
		Grey	Black	
CES 2/3	2xΦ3	600334	601334	5
CES 2/4	2xΦ4	600335	601335	5
CES 2/5	2xΦ5	600336	601336	5
CES 2/6	2xΦ6	600337	601337	5
CES 2/7	2xΦ7	600338	601338	5
CES 2/8	2xΦ8	600339	601339	5
CES 4/3	4xΦ3	600340	601340	5
CES 4/4	4xΦ4	600341	601341	5
CES 4/5	4xΦ5	600342	601342	5
CES 4/6	4xΦ6	600343	601343	5

**Drilling, wide cable range**

Material: TPE halogen free  
 Color: Light Grey, Black  
 Temperature: -40°C-140°C  
 Protection level: IP54  
 Flame Class: UL94: V0

Type	Clamping range mm	Size	Order No.	PU
KTMB 6.5	2.5-6.5	CES small	600527	5
KTMB 7.5	4-7.5	CES small	600528	5
KTMB 10	6.5-10	CES small	600529	5
KTMB 13	9.5-13	CES small	600530	5
KTMB 16	13-16	CES small	600531	5

**Drilling, wide cable range**

Material: TPE halogen free  
 Color: Light Grey, Black  
 Temperature: -40°C-140°C  
 Protection level: IP54  
 Flame Class: UL94: V0

Type	Clamping range mm	Size	Order No.	PU
CES DPF-A	3-12	CES small	600532	5

## CES DT Cable entry inserts



Material: TPE halogen free  
 Color: Light Grey, Black  
 Temperature: -40°C-140°C  
 Protection level: IP54  
 Flame Class: UL94: V0

Type	Clamping range mm	Size	Order No.	PU
KTMB 18	13-18	CES medium	600533	5
KTMB 23	18-23	CES medium	600534	5
KTMB 28	23-28	CES medium	600535	5
KTMB 33	28-33	CES medium	600536	5

## Cable Entry Inserts, multi range



Material: TPE halogen free  
 Color: Light Grey, Black  
 Temperature: -40°C-140°C  
 Protection level: IP54  
 Flame Class: UL94: V0

Type	Clamping range mm	Size	Order No.	PU
KTMB2x18	2x13-18	CES medium	600537	5

## Cable Entry Inserts, multi range



Material: TPE halogen free  
 Color: Light Grey, Black  
 Temperature: -40°C-140°C  
 Protection level: IP54  
 Flame Class: UL94: V0

Type	Clamping range mm	Size	Order No.	PU
CES DPF-B	4-18	CES medium	600538	5
CES DPF-C	11-23	CES medium	600539	5
CES DPF-D	14-26	CES medium	600540	5

## Cable Entry Inserts, multi range



Material: TPE halogen free  
 Color: Light Grey, Black  
 Temperature: -40°C-140°C  
 Protection level: IP54  
 Flame Class: UL94: V0

DT cable entry inserts are designed for routing standard cables (wireless connector)

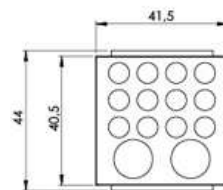

CES DT1

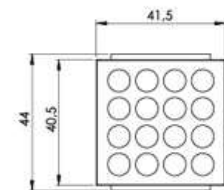

CES DT2

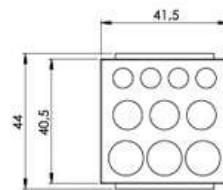

CES DT3

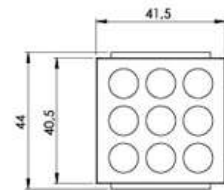

CES DT4

Type	Cable number	Order No.	PU
CES DT1	12x max.6.5mm/2x max.12.2mm	600460	10
CES DT2	16x max.7.1mm	600461	10
CES DT3	4x max.6.5/3x max.9.5/3x max.11.3mm	600462	10
CES DT4	9x max.9.5mm	600463	10

## CES Conversion template



Material: TPE halogen free  
 Color: Light Grey, Black  
 Temperature: -40°C-140°C  
 Protection level: IP54  
 Flame Class: UL94: V0

Type	Size	Order No.		PU
		Grey	Black	
CES BSA	conversion template from large to small	600344	601344	5
CES BSG	solid template small	600345	601345	5
CES BBG	solid template medium	600346	601346	5

## CES plugs for sealing



Material: Nylon 66 halogen free  
 Color: white  
 Flame Class: UL94: V0

Type	Diameter mm	length mm	Order No.	PU
CES PT2	2	25	600402	5
CES PT3	3	25	600403	5
CES PT4	4	25	600404	5
CES PT5	5	25	600405	5
CES PT6	6	25	600406	5
CES PT7	7	25	600407	5
CES PT8	8	20	600408	5
CES PT9	9	20	600409	5
CES PT10	10	20	600410	5
CES PT11	11	20	600411	5
CES PT12	12	20	600412	5
CES PT13	13	20	600413	5
CES PT14	14	20	600414	5
CES PT15	15	20	600415	5
CES PT16	16	20	600416	5
CES PT17	17	20	600417	5

# Transparent contact protection window hood

## Transparent contact protection window hood

- It is applicable for special waterproof ,dustproof and corrosion-proof locations
- Executive standard: IEC60529 IP67 EN 60309

Outline dimension, mounting hole and hole position diagram of LK4-12B window product

Order code 0412B



LK4-12B

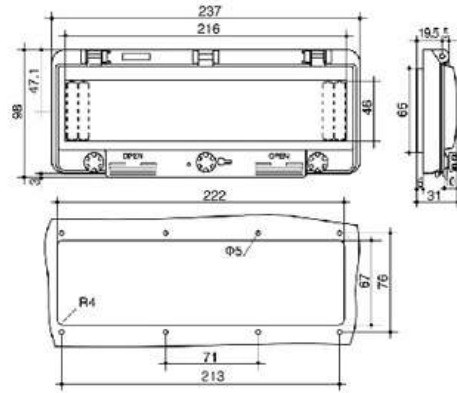

Outline dimension, mounting hole and hole position diagram of LK4-13B window product

Order code 0413B



LK4-13B

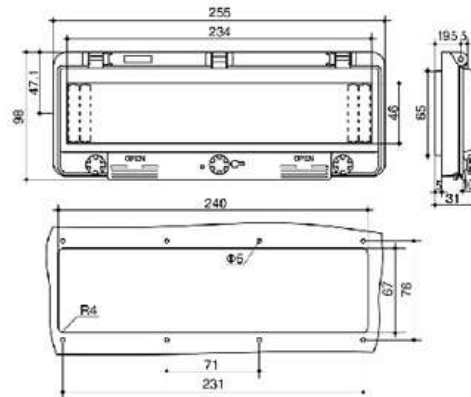

Outline dimension, mounting hole and hole position diagram of LK4-16B window product

Order code 0416B



LK4-16B

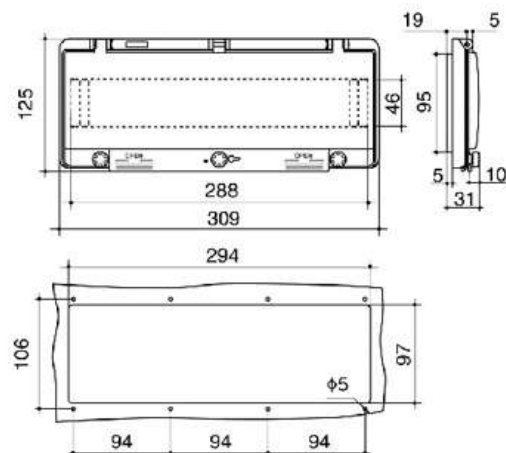



LK4-16A

Outline dimension, mounting hole and hole position diagram of LK4-16A window product

Order code 0416A

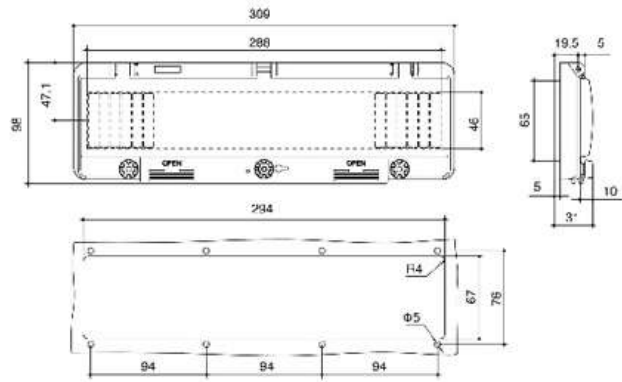

LK4-2

Outline dimension, mounting hole and hole position diagram of LK4-2 window product

Order code 0402

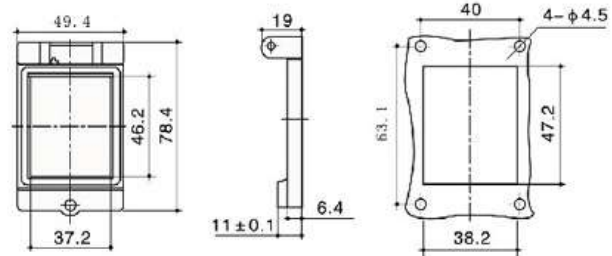

LK4-4

Outline dimension, mounting hole and hole position diagram of LK4-4 window product

Order code 0404

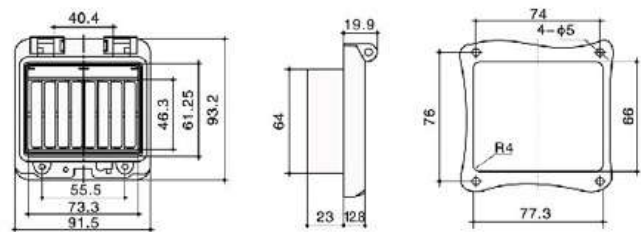

LK4-6

Outline dimension, mounting hole and hole position diagram of LK4-6 window product

Order code 0406

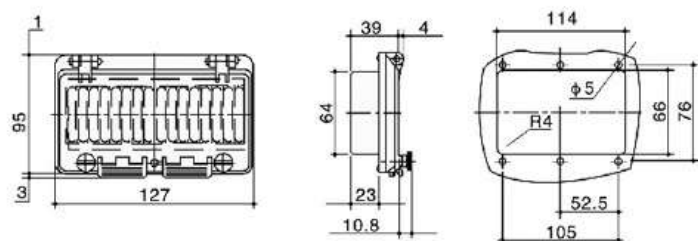

# Transparent contact protection window hood



LK4-2A

Outline dimension, mounting hole and hole position diagram of LK4-2A window product

Order code 0402A

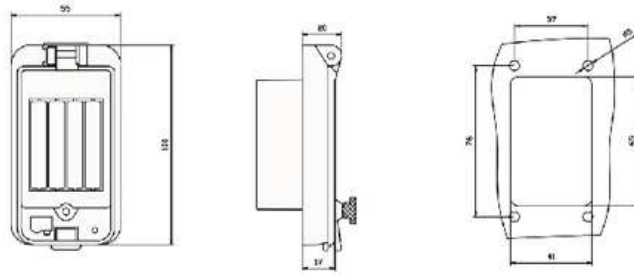

LK4-8

Outline dimension, mounting hole and hole position diagram of LK4-8 window product

Order code 0408

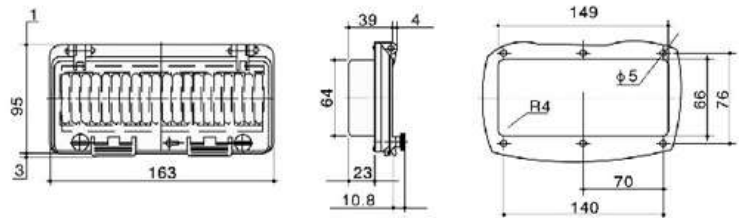

LK4-12

Outline dimension, mounting hole and hole position diagram of LK4-12 window product

Order code 0412

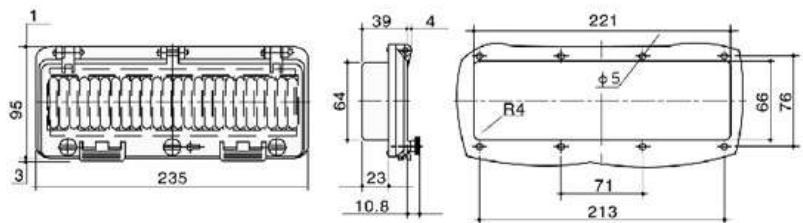

LK4-00

Product appurtenance

Order code 0400

### SFZ/SKL EMC Shield clamps



Material  
 Spring steel zinc-plated  
 SF-/SFZ-foot      Spring steel

#### Product description

The shield clamps SFZ/SKL range are used for shielding single cables in combination with strain relief. Simple to use and effective shielding of cables.

Cables are secured with a cable tie. Strain relief in accordance with VDE standards is achieved.

For assembly on 35 mm DIN rails.

#### Advantages

- Simple and tool-free assembly
- Cost effective solution
- Strain relief of the cable with shielding in a single device
- Optimal contact of the cable shielding
- Permanent and continuous spring pressure on the cable shield, adjustment of spring load not necessary

Type	Order No.	Shield diameter	PU
SFZ SKL 3-5	36855	3.0-5.0mm	10
SFZ SKL 6-8	36860	6.0-8.0mm	10
SFZ SKL 9-11	36865	9.0-11.0mm	10

### SF/SKL EMC Shield clamps



Material  
 Spring steel zinc-plated  
 SF-foot      Spring steel

#### Product description

The shield clamps SKL range are used for shielding single cables. Simple to use and effective shielding of cables.

For assembly on 35 mm DIN rails.

#### Advantages

- Optimal contact of the cable shield
- Simple and tool-free assembly
- Permanent and continuous spring pressure on the cable shield - adjustment of the pressure is not necessary
- Space saving by an optimized arrangement
- Cost effective solution

Type	Order No.	Shield diameter	PU
SF SKL 3-5	36244	3.0-5.0mm	10
SF SKL 6-8	36245	6.0-8.0mm	10
SF SKL 9-11	36246	9.0-11.0mm	10

## LFZ/SKL EMC Shield clamps

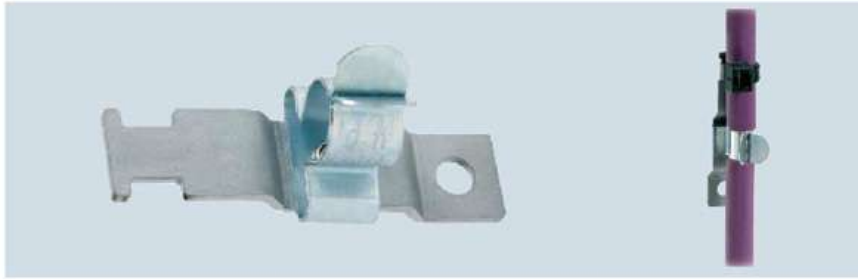

**Material**  
Spring steel zinc-plated

### Product description

SKL shield clamps can be used for shielding single cables. The shield clamps enable an easy to use and reliable shielding of cables. Cables are secured with a cable tie. Strain relief in accordance with VDE standards is achieved. Shield clamps are easily attached to mounting plates via screw.

### Advantages

- Integrated strain relief
- Optimal contact of the cable shielding
- Simple and tool-free assembly
- Permanent and continuous pressure on the cable shield - no adjustment of the spring load required
- Cost effective solution

Type	Order No.	Shield diameter	Fixing hole	PU
LFZ SKL 3-5	36915	3.0-5.0mm	4.1mm	10
LFZ SKL 6-8	36920	6.0-8.0mm	4.1mm	10
LFZ SKL 9-11	36925	9.0-11.0mm	4.1mm	10

## LF/SKL EMC Shield clamps



**Material**  
SKL-clamp Spring steel, zinc-plated  
LF-foot Steel, galvanically zinc-plated  
Fixing hole 4.2 mm for screw M4

### Product description

SKL shield clamps can be used for shielding single cables. The shield clamps enable an easy to use and a reliable shielding of cables. Shield clamps are easily attached to mounting plates via screw.

### Advantages

- Optimal contact of the cable shielding
- Simple and tool-free assembly
- Permanent and continuous spring load on the cable shield - no adjustment of the spring load required
- Vibration-proof, maintenance free
- High packing density because of an optimized arrangement

Type	Order No.	Shield diameter	Fixing hole	PU
LF SKL 1.5-3	36251	1.5 - 3.0 mm	4.2 mm	10
LF SKL 3-6	36253	3.0 - 6.0 mm	4.2 mm	10
LF SKL 6-8	36255	6.0 - 8.0 mm	4.2 mm	10
LF SKL 8-11	36256	8.0 - 11 mm	4.2 mm	10
LF SKL 12-16	36257	12 - 16 mm	4.2 mm	10
LF SKL 17-22	36258	17 - 22 mm	4.2 mm	10
LF SKL 23-29	36259	23 - 29 mm	4.2 mm	10

### SPS/SKL EMC Shielded Clamps



Specification:

**Material**

SKL-clamp Spring steel, zinc-plated  
SFS-foot Spring steel

**Advantages**

Easy installation to din rail 35mm  
Simple and tool-free assembly  
High packing density  
Vibration-proof, maintenance free  
Optimal contact of the cable shielding

Type	Order No.	Shield diameter	PU
SPS SKL 1.5-3	36855	1.5-3.0mm	5
SPS SKL 3-6	36860	3.0-6.0mm	5
SPS SKL 6-8	36865	6.0-8.0mm	5

### PF/SKL EMC clamps for bus bar



Specification: mounted by snapping on a 10x3mm bus bar

**Material**

SKL-clamp Spring steel, zinc-plated  
PFS-foot Spring steel  
Busbar Cu, tin-plated, current load to 140A

**Advantages**

Easy installation to bus bar 10x3mm  
Simple and tool-free assembly  
High packing density  
Vibration-proof, maintenance free  
Optimal contact of the cable shielding

Type	Order No.	Shield diameter	PU
PF SKL 1.5-3	36251	1.5 - 3.0 mm	5
PF SKL 3-6	36253	3.0 - 6.0 mm	5
PF SKL 6-8	36255	6.0 - 8.0 mm	5
PF SKL 8-11	36256	8.0 - 11 mm	5
PF SKL 12-16	36257	12 - 16 mm	5
PF SKL 17-22	36258	17 - 22 mm	5
PF SKL 23-29	36259	23 - 29 mm	5

### PFZ/SKL EMC Shielded clamps for bus bar



Specification: mounted by snapping on a 10x3mm bus bar

Fix cable with a cable tie

**Material**

SKL-clamp Spring steel, zinc-plated  
PFS-foot Spring steel  
Busbar Cu, tin-plated, current load to 140A

**Advantages**

Integrated strain relief Vibration-proof, maintenance free  
Easy installation to bus bar 10x3mm Optimal contact of the cable shielding  
Simple and tool-free assembly

Type	Order No.	Shield diameter	PU
PFZ SKL 1.5-3	36244	1.5-3.0mm	5
PFZ SKL 3-6	36245	3.0-6.0mm	5
PFZ SKL 6-8	36246	6.0-8.0mm	5
PFZ SKL 8-11		8.0-11.0mm	5

## PFZ/SKL EMC Shielded clip



Specification: mounted by snapping on a 10x3mm bus bar

**Material**

SKL-clamp Spring steel,zinc-plated  
 PF-foot Spring steel  
 Busbar Cu, tin-plated, current load to 140A

**Advantages**

Easy installation to bus bar 10x3mm  
 Simple and tool-free assembly  
 High packing density  
 Vibration-proof,maintenance free  
 Optimal contact of the cable shielding

Type	Order No.	Shield diameter	PU
PFZ SKL 1.5-3	36244	1.5-3.0mm	5
PFZ SKL 3-6	36245	3.0-6.0mm	5
PFZ SKL 6-8	36246	6.0-8.0mm	5
PFZ SKL 8-11		8.0-11.0mm	5

## LFZ/SKL EMC Shielded Clip



Specification: mounted by screw, 4.2mm hole for fixing

**Material**

SKL-clamp Spring steel,zinc-plated  
 PF-foot Spring steel

**Advantages**

Simple and tool-free assembly  
 High packing density  
 Vibration-proof,maintenance free  
 Optimal contact of the cable shielding

Type	Order No.	Shield diameter	PU
LFZ SKL 1.5-3	36251	1.5 - 3.0 mm	5
LFZ SKL 3-6	36253	3.0 - 6.0 mm	5
LFZ SKL 6-8	36255	6.0 - 8.0 mm	5
LFZ SKL 8-11	36256	8.0 - 11 mm	5
LFZ SKL 12-16	36257	12 - 16 mm	5
LFZ SKL 17-22	36258	17 - 22 mm	5
LFZ SKL 23-29	36259	23 - 29 mm	5

## TW/RL EMC Shielded Clip



Specification: mounted by snapping on a 10x3mm bus bar

**Material**

SKL-clamp Spring steel,zinc-plated  
 PF-foot Spring steel  
 Busbar Cu, tin-plated, current load to 140A

**Advantages**

Easy installation to bus bar 10x3mm  
 Simple and tool-free assembly  
 High packing density  
 Vibration-proof,maintenance free  
 Optimal contact of the cable shielding

Type	Order No.	Shield diameter	PU
TW RL 1.5-3	36855	1.5-3.0mm	5
TW RL 3-6	36860	3.0-6.0mm	5
TW RL 6-8	36865	6.0-8.0mm	5

## KLF EMC Shielded Clip



Specification:

**Material**  
SKL-clamp Spring steel,zinc-plated  
Base Stainless steel

**Advantages**  
High packing density due to optimized arrangement  
Possibility to configure custom specific EMC clamp assembly

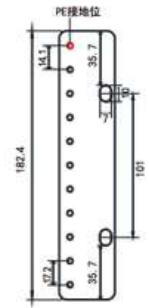

Type	Order No.	Number of terminals	PU
KLF 10/182.4(3-6)	36855	10	5
KLF 10/182.4(6-8)	36860	10	5
KLF 10/182.4(8-11)	36865	10	5

## LF/SKL EMC Shielded Clip



Specification: mounted by screw, 4.2mm hole for fixing

**Material**  
SKL-clamp Spring steel,zinc-plated  
LF-foot Spring steel

**Advantages**  
High packing density  
Vibration-proof,maintenance free  
Optimal contact of the cable shielding

Type	Order No.	Shield diameter	PU
LF SKL 1.5-3	36251	1.5 - 3.0 mm	5
LF SKL 3-6	36253	3.0 - 6.0 mm	5
LF SKL 6-8	36255	6.0 - 8.0 mm	5
LF SKL 8-11	36256	8.0 - 11 mm	5
LF SKL 12-16	36257	12 - 16 mm	5
LF SKL 17-22	36258	17 - 22 mm	5
LF SKL 23-29	36259	23 - 29 mm	5

## TW2/RL EMC Shielded Clip

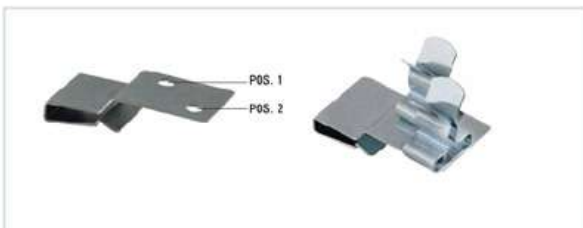

Specification: mounted by snapping on a 10x3mm bus bar

**Material**  
SKL-clamp Spring steel,zinc-plated  
PF-foot Spring steel  
Busbar Cu, tin-plated, current load to 140A

**Advantages**  
Easy installation to bus bar 10x3mm  
Simple and tool-free assembly  
High packing density  
Vibration-proof,maintenance free  
Optimal contact of the cable shielding

Type	Order No.	Shield diameter POS.1	Shield diameter POS.2	PU
TW2 RL 1.5-3	36251	1.5 - 3.0 mm	1.5 - 3.0 mm	5
TW2 RL 3-6	36253	3.0 - 6.0 mm	3.0 - 6.0 mm	5
TW2 RL 6-8	36255	6.0 - 8.0 mm	6.0 - 8.0 mm	5
TSC2 RL 0306	36256	1.5 - 3.0 mm	3.0 - 6.0 mm	5
TSC2 SKL 0308	36257	1.5 - 3.0 mm	6.0 - 8.0 mm	5
TSC2 SKL 0603	36258	3.0 - 6.0 mm	1.5 - 3.0 mm	5
TSC2 SKL 0608	36259	3.0 - 6.0 mm	6.0 - 8.0 mm	5
TSC2 SKL 0803	36259	6.0 - 8.0 mm	1.5 - 3.0 mm	5
TSC2 SKL 0806	36259	6.0 - 8.0 mm	3.0 - 6.0 mm	5

## KLF EMC Shielded Clip



Specification:

**Material**

SKL-clamp Spring steel,zinc-plated

Base Stainless steel

**Advantages**

High packing density due to optimized arrangement

Possibility to configure custom specific EMC clamp assembly

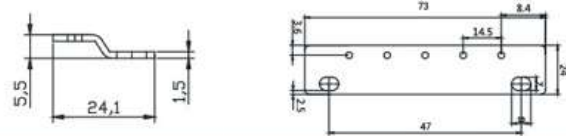

Type	Order No.	Number of terminals	PU
KLF 5/73(3-6)	36855	5	5
KLF 5/73(6-8)	36860	5	5
KLF 5/73(8-11)	36865	5	5

## KLF EMC Shielded clip



Specification:

**Material**

SKL-clamp Spring steel,zinc-plated

Base Stainless steel

**Advantages**

High packing density due to optimized arrangement

Possibility to configure custom specific EMC clamp assembly

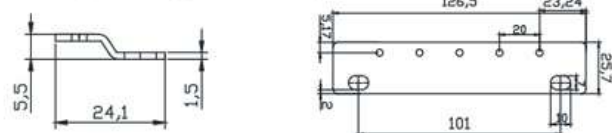

Type	Order No.	Number of terminals	PU
KLF 5/126.5(3-6)	36855	5	5
KLF 5/126.5(6-8)	36860	5	5
KLF 5/126.5(8-11)	36865	5	5

## KLF EMC Shielded clip



Specification:

**Material**

SKL-clamp Spring steel,zinc-plated

Base Stainless steel

**Advantages**

High packing density due to optimized arrangement

Possibility to configure custom specific EMC clamp assembly

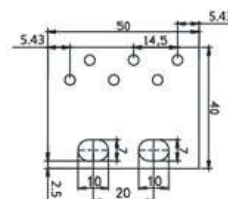

Type	Order No.	Number of terminals	PU
KLF 5/50(3-6)	36855	6	5
KLF 5/50(6-8)	36860	6	5
KLF 5/50(8-11)	36865	6	5

## Clamping yoke

The electromagnetic compatibility (EMC) of electrical machines and installations has become a very important aspect.

These are available in different versions.

Material: Steel

### LK 2X2-6



#### Dimensions and weights

Length	24 mm
Width	15 mm
Height	18 mm
Net weight	9.9 g
Cable diameter, min.	2 mm
Cable diameter, max.	6 mm

### LK 3-8



#### Dimensions and weights

Length	26 mm
Width	13 mm
Height	18 mm
Net weight	9 g
Cable diameter, min.	3 mm
Cable diameter, max.	8 mm

### LK 3-8 FM4



#### Dimensions and weights

Length	50 mm
Width	14.5 mm
Height	26 mm
Net weight	17.5 g
Cable diameter, min.	3 mm
Cable diameter, max.	8 mm

### LK 4-13.5



#### Dimensions and weights

Length	24 mm
Width	15 mm
Height	18 mm
Net weight	15.5 g
Cable diameter, min.	4 mm
Cable diameter, max.	13.5 mm

Material: Steel

## LK 4-13.5 FM4



## Dimensions and weights

Length	50.5 mm
Width	20.5 mm
Height	31.5 mm
Net weight	21.941 g
Cable diameter, min.	4 mm
Cable diameter, max.	13.5 mm

## LK 10-20



## Dimensions and weights

Length	40 mm
Width	25 mm
Height	26 mm
Net weight	29.848 g
Cable diameter, min.	10 mm
Cable diameter, max.	20 mm

## LK 10-20 FM4



## Dimensions and weights

Length	50.5 mm
Width	25 mm
Height	40 mm
Cable diameter, min.	10 mm
Cable diameter, max.	20 mm

## LK 15-32



## Dimensions and weights

Length	64 mm
Width	36 mm
Height	32 mm
Net weight	80.8 g
Cable diameter, min.	15 mm
Cable diameter, max.	32 mm

## LK 15-32 FM4



## Dimensions and weights

Length	50.5 mm
Width	34.5 mm
Height	64 mm
Cable diameter, min.	15 mm
Cable diameter, max.	32 mm

2018~2019



**LINKWELL**  
FUTURE-ORIENTED

Email: [info@linkwell.org](mailto:info@linkwell.org)

Web: [www.linkwell.org](http://www.linkwell.org), [www.cnlinkwell.com](http://www.cnlinkwell.com)