



NC1 AC Contactor, 9~95A

1. General

- 1.1 Certificates: CE, KEMA, VDE, EK, UKrSEPRO, EAC, RCC, UL;
- 1.2 Electric ratings: AC50/60Hz, 690V, up to 95A;
- 1.3 Application: remote making & breaking circuits; protect circuit from over-load when assembling with thermal over-load relay; Frequent start-up and control of AC contactor;
- 1.4 Utilization category: AC-3, AC-4;
- 1.5 Altitude: ≤2000m;
- 1.6 Ambient temperature: -5°C~+40°C;
- 1.7 Mounting category: III
- 1.8 Mounting conditions:
inclination between the mounting plane and the vertical plane should not exceed ±5°
- 1.9 Standard: IEC/EN 60947-4-1

2. Type designation

NC1-□□□□-□

Z: DC coil
N: Reversing/change-over type contactor

Number of contacts

10: 3 N/O main contacts+1 N/O auxiliary contact (9A,12A,18A,25A,32A)

01: 3 N/O main contacts+1 N/C auxiliary contact (9A,12A,18A,25A,32A)

11: 3 N/O main contacts+1 N/O and 1N/C auxiliary contact (40A,50A,65A,80A,95A)

04: 4 N/O main contacts (9A,12A,25A,40A,50A,65A,80A,95A)

08: 2 N/O and 2N/C main contacts (9A,12A,25A,40A,50A,65A,80A,95A)

Basic specification, expressed with the rated operational current 400(380)V, AC-3

Design sequence No.

Contactor

Company code



3. Curves

Electric life curves (AC-3)

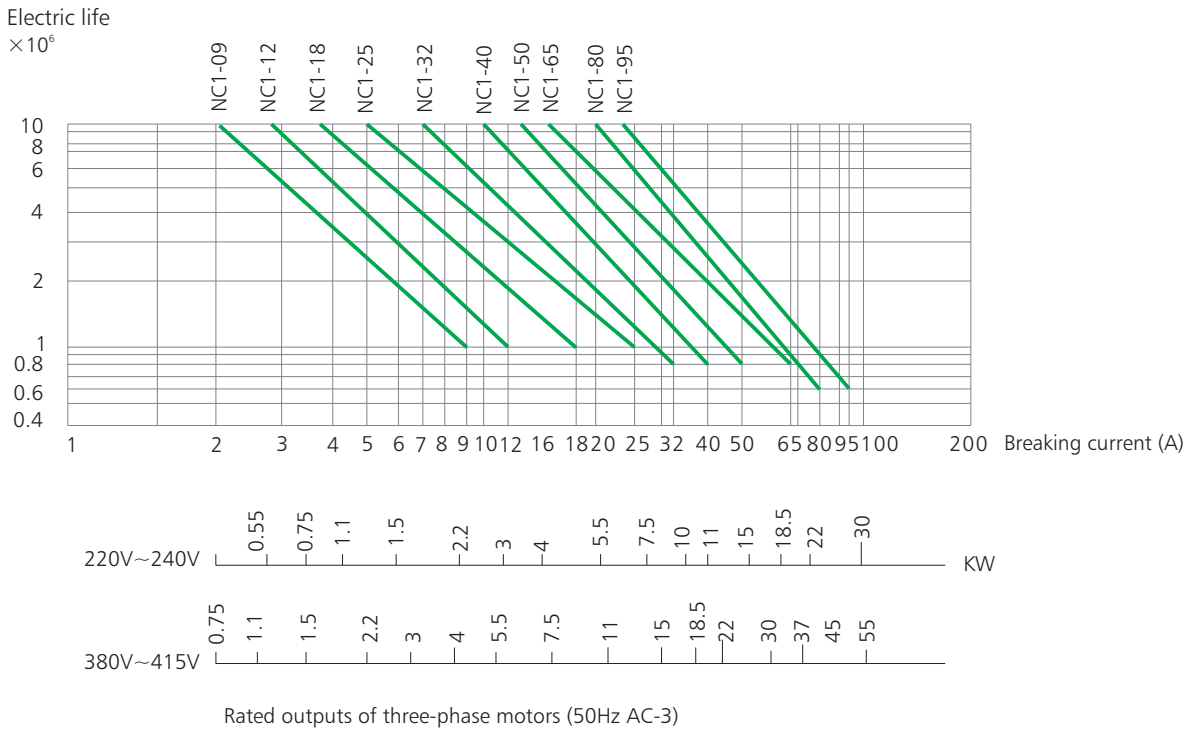

Electric life curves (AC-4)

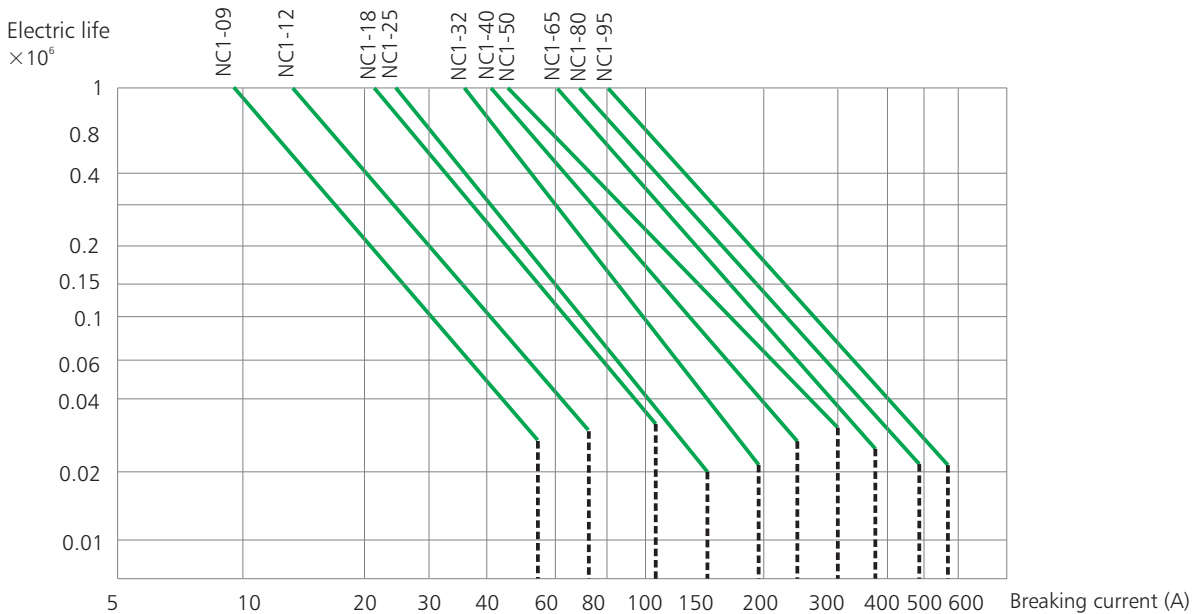

Example:

Request to control the start of three-phase motors

main technical parameter of three-phase motors: P=5.5kW, Ue=400V(380V), Ie=11A, I_{c6}×Ie=66A



The electric life span of request: 2,00,000 operations

the contactor should be NC1-32 according to the curves above

4. Technical data

4.1 AC coil contactor

★ AC coil operation



Items		Model	NC1-09	NC1-12	NC1-18	NC1-25
		Frame	Frame 1 (3P, 4P)		Frame 2 (3P)	Frame 3 (3P, 4P)
						
Rated conventional heating current (A) AC-1			25	25	32	40
Rated operational current (A)	400(380)V	AC-3	9	12	18	25
		AC-4	3.5	5	7.7	8.5
	690(660)V	AC-3	6.6	8.9	12	18
		AC-4	1.5	2	3.8	4.4
Rated insulation voltage (V AC)			690	690	690	690
Power of controlled 3-phase cage motor (AC-3)	kW	230(220)V AC	2.2	3	4	5.5
		400(380)V AC	4	5.5	7.5	11
		690(660)V AC	5.5	7.5	10	15
	hp	200V AC	3	5	7.5	7.5
		240V AC	3	5	7.5	10
		460V AC	5	7.5	10	15
		600V AC	5	7.5	10	15
	Operating frequency (operations/h)	Electrical	AC-3	1,200	1,200	1,200
AC-4			300	300	300	300
Mechanical		3,600	3,600	3,600	3,600	
Electrical life (× 10 ³ operations)	AC-3		1,000	1,000	1,000	1,000
	AC-4		200	200	200	200
Mechanical life (× 10 ⁶ operations)			10	10	10	10
Matched fuse type			RT16-20	RT16-20	RT16-32	RT16-40

★ AC coil operation, reversing type

Items		Model	NC1-09N	NC1-12N	NC1-18N	NC1-25N
		Frame	Frame 1 (3P, 4P)		Frame 2 (3P)	Frame 3 (3P, 4P)
Rated conventional heating current (A) AC-1			25	25	32	40
AC-4	I _e (A)	380/400V	3.5	5	7.7	8.5
		660/690V	1.5	2	3.8	4.4
	P _e (kW)	380/400V	1.5	2.2	3	4
		660/690V	1.1	1.5	3.7	4
Power of controlled 3-phase cage motor (AC-3)	hp	200V	3	5	7.5	7.5
		240V	3	5	7.5	10
		460V	5	7.5	10	15
		600V	5	7.5	10	15

★ AC coil operation, change-over type

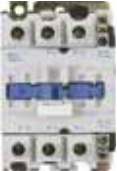
Items		Model	NC1-09N	NC1-12N	NC1-25N
		Frame	Frame 1 (4P)	Frame 2 (4P)	Frame 3 (4P)
Rated conventional heating current (A) AC-1			25	25	40
AC-4	I _e (A)	380/400V	3.5	5	8.5
		660/690V	1.5	2	4.4
	P _e (kW)	380/400V	1.5	2.2	4
		660/690V	1.1	1.5	4
Power of controlled 3-phase cage motor (AC-3)	hp	200V	3	5	7.5
		240V	3	5	10
		460V	5	7.5	15
		600V	5	7.5	15



	NC1-32	NC1-40	NC1-50	NC1-65	NC1-80	NC1-95
	Frame 4 (3P)	Frame 5 (3P, 4P)			Frame 6 (3P, 4P)	
						
	50	60	80	80	110(Can be customized for 125)	110(Can be customized for 125)
	32	40	50	65	80	95
	12	18.5	24	28	37	44
	21	34	39	42	49	49
	7.5	9	12	14	17.3	21.3
	690	690	690	690	690	690
	7.5	11	15	18.5	22	25
	15	18.5	22	30	37	45
	18.5	30	37	37	45	45
	10	15	15	20	25	30
	15	20	20	25	30	30
	20	25	30	40	40	50
	20	25	30	40	40	50
	600	600	600	600	600	600
	300	300	300	300	300	300
	3,600	3,600	3,600	3,600	3,600	3,600
	800	800	600	600	600	600
	200	150	150	150	100	100
	8	8	8	8	6	6
	RT16-50	RT16-63	RT16-80	RT16-80	RT16-100	RT16-125



NC1-32N	NC1-40N	NC1-50N	NC1-65N	NC1-80N	NC1-95N
Frame 4 (3P)	Frame 5 (3P, 4P)			Frame 6 (3P, 4P)	
50	60	80	80	110(Can be customized for 125)	110(Can be customized for 125)
12	18.5	24	28	37	44
7.5	9	12	14	17.3	21.3
5.5	7.5	11	15	18.5	22
5.5	7.5	11	11	15	18.5
10	15	15	20	25	30
15	20	20	25	30	30
20	25	30	40	40	50
20	25	30	40	40	50

NC1-40N	NC1-50N	NC1-65N	NC1-80N	NC1-95N
Frame 4 (4P)	Frame 5 (4P)		Frame 6 (4P)	
60	80	80	110(Can be customized for 125)	110(Can be customized for 125)
18.5	24	28	37	44
9	12	14	17.3	21.3
7.5	11	15	18.5	20
7.5	11	11	15	18.5
15	15	20	25	30
20	20	25	30	30
25	30	40	40	50
25	30	40	40	50

4.2 DC coil contactor

★ DC coil operation(24V,110V,220V)

Items		Model	NC1-09Z	NC1-12Z	NC1-18Z	NC1-25Z
			Frame 1 (3P, 4P)		Frame 2 (3P)	Frame 3 (3P, 4P)
						
Rated conventional heating current (A) AC-1			25	25	32	40
Rated operational current (A)	400(380)V	AC-3	9	12	18	25
		AC-4	3.5	5	7.7	8.5
	690(660)V	AC-3	6.6	8.9	12	18
		AC-4	1.5	2	3.8	4.4
Conventional heating current (A)			25	25	32	40
Rated insulation voltage (V AC)			690	690	690	690
Power of controlled 3-phase cage motor (AC-3)	kW	230(220)V AC	2.2	3	4	5.5
		400(380)V AC	4	5.5	7.5	11
		690(660)V AC	5.5	7.5	10	15
Operating frequency (operations/h)	Electrical	AC-3	1,200	1,200	1,200	1,200
		AC-4	300	300	300	300
	Mechanical			3,600	3,600	3,600
Electrical life ($\times 10^3$ operations)	AC-3		1,000	1,000	1,000	1,000
	AC-4		200	200	200	200
Mechanical life ($\times 10^6$ operations)			10	10	10	10
Matched fuse type			RT16-20	RT16-20	RT16-32	RT16-40

	NC1-32Z Frame 4 (3P)	NC1-40Z	NC1-50Z	NC1-65Z	NC1-80Z	NC1-95Z
		Frame 5 (3P, 4P)			Frame 6 (3P, 4P)	
						
	50	60	80	80	110(Can be customized for 125)	110(Can be customized for 125)
	32	40	50	65	80	95
	12	18.5	24	28	37	44
	21	34	39	42	49	49
	7.5	9	12	14	17.3	21.3
	50	60	80	80	110(Can be customized for 125)	110(Can be customized for 125)
	690	690	690	690	690	690
	7.5	11	15	18.5	22	25
	15	18.5	22	30	37	45
	18.5	30	37	37	45	45
	600	600	600	600	600	600
	300	300	300	300	300	300
	3,600	3,600	3,600	3,600	3,600	3,600
	800	800	600	600	600	600
	200	150	150	150	100	100
	8	8	8	8	6	6
	RT16-50	RT16-63	RT16-80	RT16-80	RT16-100	RT16-125

5. Accessories

5.1 Accessories

Items		Model	NC1-09	NC1-12	NC1-18	NC1-25
AC coil	Coil power	In-rush (VA)	70	70	70	110
		Sealed (VA)	9	9	9.5	14
		Power (W)	1.8~2.7	1.8~2.7	3~4	3~4
	Operation range	Operation voltage	(85%~110%) Us			
		Drop-out voltage	(20%~75%) Us			
	Coil voltage(50Hz,60Hz, 50/60Hz)(V)		24,36,48,110,127,220,240,380,415,440,480,500,600,660			
DC coil	Coil power(W)		9	9	11	11
	Operation range	Pick-up voltage	(85%~110%) Us			
		Drop-out voltage	(10%~75%) Us			
	Coil voltage (V)		24,36,48,110,220			

F4 auxiliary contact

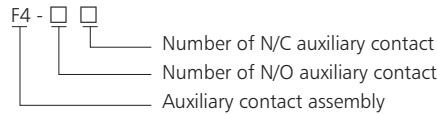

F5 auxiliary contact

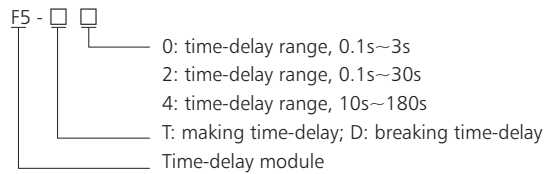



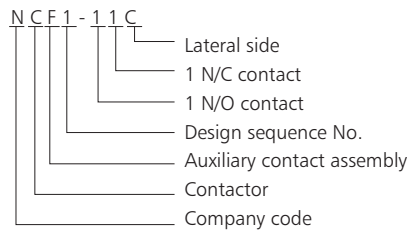













NCF1-11C lateral side auxiliary contact





NC1-32	NC1-40	NC1-50	NC1-65	NC1-80	NC1-95
110	200	200	200	200	200
14	57	57	57	57	57
3~4	6~10	6~10	6~10	6~10	6~10
(85%~110%) Us					
(20%~75%) Us					
24,36,48,110,127,220,240,380,415,440,480,500,600					
11	20	20	20	20	20
(85%~110%) Us					
(10%~75%) Us					

Picture	Model	Configuration of contacts		
		Number of N/O contact	Number of N/C contact	
	F4-20	2	0	
	F4-11	1	1	
	F4-02	0	2	
	F4-40	4	0	
	F4-31	3	1	
	F4-22	2	2	
	F4-13	1	3	
	F4-04	0	4	
	Picture	Model	Time-delay range	Number of time-delay contacts
		F5-T0	0.1s~3s	N/O+N/C
		F5-T2	0.1s~30s	N/O+N/C
		F5-T4	10s~180s	N/O+N/C
		F5-D0	0.1s~3s	N/O+N/C
F5-D2		0.1s~30s	N/O+N/C	
F5-D4		10s~180s	N/O+N/C	
	Suppression voltage range	AC 24V~48V	SR2 24V~48V	ble to be used for the products of 9A~38A or lower
		AC 100V~250V	SR2 100V~250V	
		AC 380V~440V	SR2 380V~440V	
		AC 100V~127V	SR2-B 100V~127V	ble to be used for the products of 40A~95A or lower
		AC 200V~250V	SR2-B 200V~250V	
		AC 380V~440V	SR2-B 380V~440V	



5.2 Derived products when the contactor is assembled with following accessory module

Derived products	Contactor	Accessorial modular	Picture
Time-delay contactor		+  Time-delay block	
Reversing contactor		+  Mechanical interlock	
Magnetic starter		+  Thermal relay	
AC contactor for capacitor switching		+  Current-limiting contact assembly	
Star-delta starter		+  +  Time-delay block Auxiliary contact assembly	

5.3 Assembly with thermal over-load relay

Model of contactor	Assembled thermal over-load relay			
	Model	Rated current (A)	Recommended fuse type	
			aM	gG
NC1-09 NC1-12 NC1-18 NC1-25 NC1-32	 NR2-25	0.1~0.16	0.25	2
		0.16~0.25	0.5	2
		0.25~0.4	1	2
		0.4~0.63	1	2
		0.63~1	2	4
		1~1.6	2	4
		1.25~2	4	6
		1.6~2.5	4	6
		2.5~4	6	10
		4~6	8	16
		5.5~8	12	20
		7~10	12	20
		9~13	16	25
		12~18	20	35
17~25	25	50		
NC1-32	 NR2-36	23~32	40	63
		28~36	40	80
NC1-40 NC1-50 NC1-65 NC1-80 NC1-95	 NR2-93	23~32	40	63
		30~40	40	100
		37~50	63	100
		48~65	63	100
		55~70	80	125
		63~80	80	125
		80~93	100	160

5.4 Assembly with electronic overload relay

Model of contactor	Rated		Range of setting	Recommended	
	Model	Assembled thermal current (A)	Over-load relay current (A)	Fuse type	
NC1-09		1.2	0.6~1.2	RT36-4 (NT00-4)	
		2.4	1.2~2.4	RT36-6 (NT00-6)	
		4	2~4	RT36-10 (NT00-10)	
		8	4~8	RT36-16 (NT00-16)	
		10	5~10	RT36-20 (NT00-20)	
		12	7~12	RT36-25 (NT00-25)	
NC1-12	NRE8-25	20	10~20	RT36-40 (NT00-40)	
NC1-18		25	20~25	RT36-50 (NT00-50)	
NC1-25		32	22~32	RT36-80 (NT00-80)	
NC1-40			4	2~4	RT36-10 (NT00-10)
			8	4~8	RT36-16 (NT00-16)
			10	5~10	RT36-20 (NT00-20)
	20		10~20	RT36-40 (NT00-40)	
	40		20~40	RT36-80 (NT00-80)	
NC1-40	NRE8-40	65	30~65	RT36-160 (NT00-160)	
NC1-50					
NC1-65					
NC1-80					
NC1-95					100
NC1-100		100	50~100	RT36-200 (NT1-200)	
					100
					100
					100
					100

6. Technical information

6.1 Terminal connection

Model	Cabling cross section(Cu)				Screw size	Tightening torque (N · m)
	Number of piece	Flexible cable with cold-pressed socket (mm ²)	Flexible cable without cold-pressed socket (mm ²)	Inflexible cable (mm ²)		
NC1-09	1	1/2.5	1/4	1/4	M3.5	0.8
	2	1/2.5	1/2.5	1/4	M3.5	0.8
NC1-12	1	1/2.5	1/4	1/4	M3.5	0.8
	2	1/2.5	1/2.5	1/4	M3.5	0.8
NC1-18	1	1.5/4	1.5/6	1.5/6	M3.5	0.8
	2	1.5/4	1.5/4	1.5/6	M3.5	0.8
NC1-25	1	1.5/4	1.5/10	1.5/6	M4	1.2
	2	1.5/4	1.5/6	1.5/6	M4	1.2
NC1-32	1	2.5/6	2.5/10	2.5/10	M4	1.2
	2	2.5/6	2.5/6	2.5/10	M4	1.2
NC1-40	1	6/25	6/25	6/25	M8	4
	2	4/10	4/10	4/10	M8	4
NC1-50	1	6/25	6/25	6/25	M8	4
	2	4/10	4/10	4/10	M8	4
NC1-65	1	6/25	6/25	6/25	M8	4
	2	4/10	4/10	4/10	M8	4
NC1-80	1	10/35	10/35	10/35	M10	6
	2	6/16	6/16	6/16	M10	6
NC1-95	1	10/35	10/35	10/35	M10	6
	2	6/16	6/16	6/16	M10	6

7. Overall and mounting dimensions (mm)

NC1-09~32

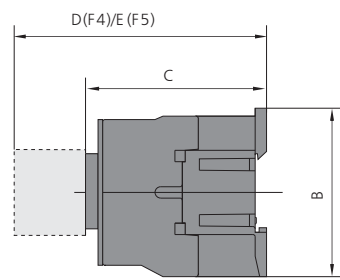
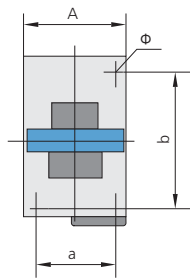

NC1-40~95

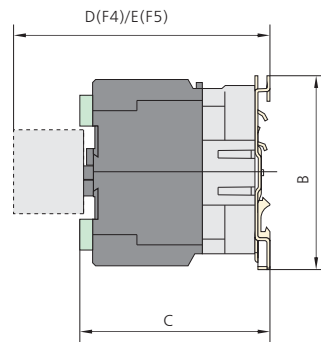
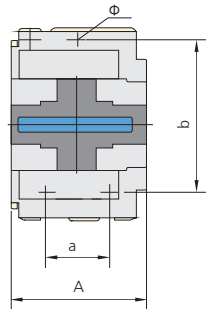

NC1-09Z~32Z

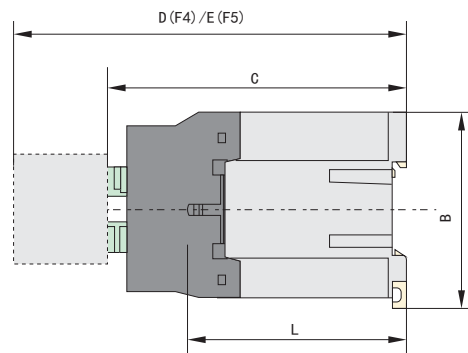
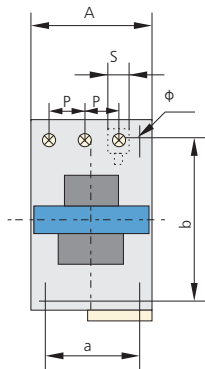

NC1-40Z~95Z

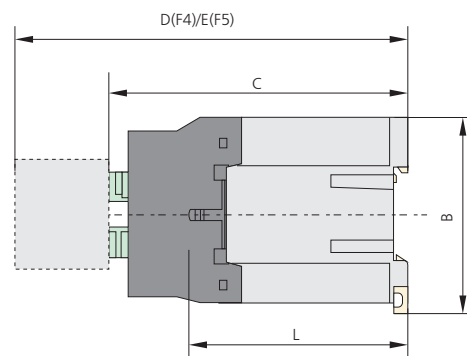
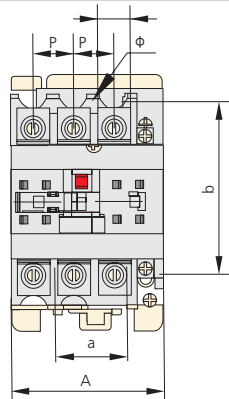

Model	A max	B max	C max	D max	E max	a	b	Φ	L	P	S
NC1-09(Z)~12(Z)	47	76	82(116)	120.5(154.5)	140.5(174.5)	34/35	50/60	4.5	60(95)	10.5	8.6
NC1-18(Z)	47	76	87(122)	125.5(160.5)	145.5(180.5)	34/35	50/60	4.5	61(96)	11.3	10.4
NC1-25(Z)	57	86	95(131)	133.5(169.5)	153.5(189.5)	40	48	4.5	70(107)	13.2	11.7
NC1-32(Z)	57	86	100(138)	138.5(176.5)	158.5(196.5)	40	48	4.5	71.6(120)	14.5	13
NC1-4011(Z)~6511(Z)	77	129	116(173)	154.5(211.5)	174.5(231.5)	40	105	6.5	78(135)	20	8.6
NC1-4004~6504	84	129	116	154.5	174.5	40	105	6.5	78(135)	20	8.6
NC1-4008~6508	84	129	127	154.5	174.5	40	105	6.5	78	20	8.6
NC1-8011(Z)~9511(Z)	87	129	127(188)	165.5(226.5)	185.5(246.5)	40	105	6.5	83(140)	23.5	12
NC1-8004~9504	96	129	122	160.5	180.5	40	105	6.5	83	23.5	12
NC1-8008~9508	96	129	135	160.5	180.5	40	105	6.5	83	23.5	12

NC1-09~32N

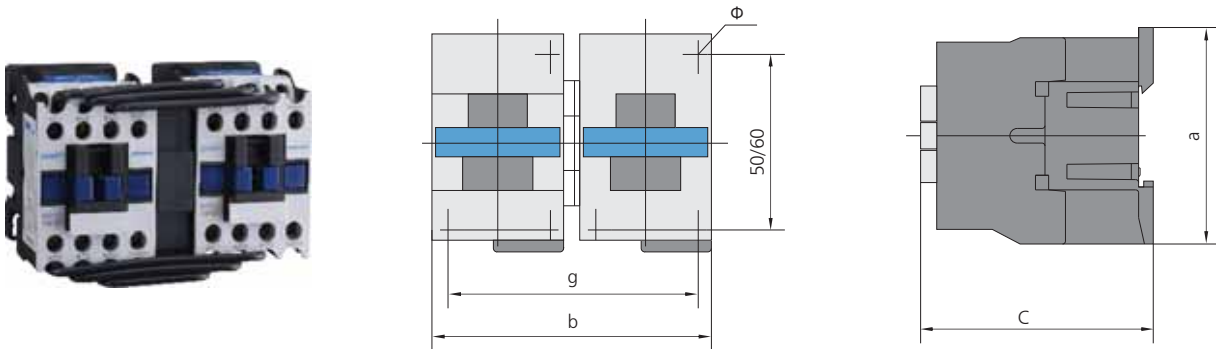

NC1-40~95N

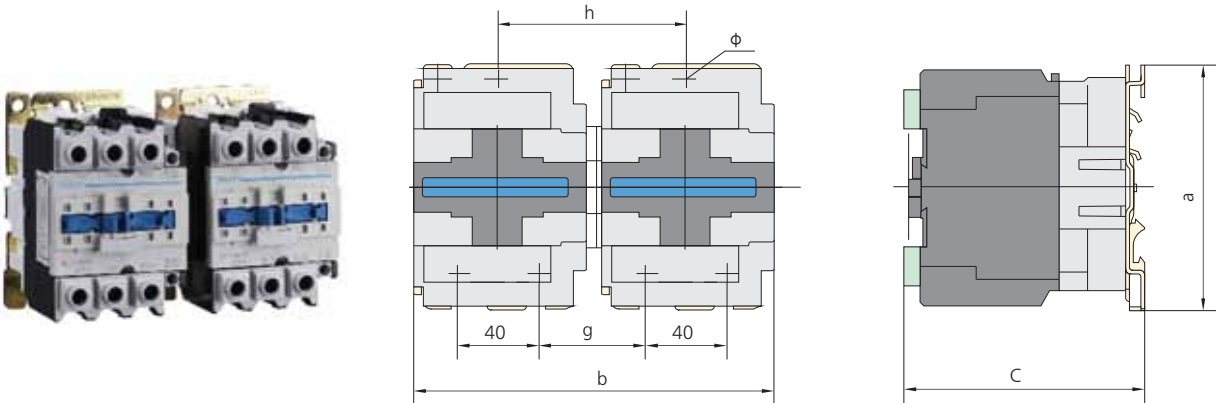

Contactor model	a	b	c	g	h	φ
NC1-09N~12N	86	109	82	95	-	4.5
NC1-18N	86	109	87	95	-	4.5
NC1-25N	93	131	95	111	-	4.5
NC1-32N	93	131	100	111	-	4.5
NC1-40N~65N(3P)	129	165	116	50	90	6.5
NC1-80N~95N(3P)	129	187	127	57	96	6.5
NC1-40N~65N(4P)	129	180	116	50	90	6.5
NC1-80N~95N(4P)	129	205	127	57	96	6.5

Note:

1. L: in main circuit, the distance between terminals and plate;
2. P: in main circuit, the distance between two phases;
3. S: in main circuit, the width of contacting plate.