



NH40SZ Automatic Changeover Switch

1. General

NH40SZ automatic changeover switch disconnecter integrates electrical and mechanical interlocking systems to guarantee safe transfer operation. It is applicable for the three-phase four-wire power supply system of AC 50Hz, rated voltage AC 380V, rated current up to 3150A. It can realize automatic and manual changeover between normal and back up power supply power, and stop power supplying to load when changeover process of power supply is carried out. The switch is applicable for two circuits power supply and in the condition which requires high quality power supply. Standard: IEC 60947-6-1

2. Type designation

N H 40 - □ / □ SZ □ □

N	H	40	-	□	/	□	SZ	□	□
								Y: Liquid crystal display	
								Normal type Main power supply —— standby power supply, automatic change and automatic recovery;	
								I : Mains supply-mains supply, mutual standby, phase loss protection; overvoltage and undervoltage protection;	
								II : Mains supply-mains supply, automatic change and automatic recovery, phase loss protection, overvoltage and undervoltage protection;	
								III : Mains supply-oil engine, automatic change and automatic recovery, phase loss protection, overvoltage and undervoltage protection;	
								Dual-power supply automatic transfer	
								"3" represents three poles "4" represents four poles	
								Rated operational current	
								Design sequence No.	
								Isolating switch	
								Company code	

3. Technical data

Conventional thermal current (A)		16	32	40	63	80	100	125	160	200	250	315	400	630	800	1000	1250	1600	2000	2500	3150			
I _e	(A)	16	32	40	63	80	100	125	160	200	250	315	400	630	800	1000	1250	1600	2000	2500	3150			
U _i	(V)	660												800										
U _{imp}	(V)	8												12										
U _e , U _s		U _e =400V; U _s =220V																						
Rated making and breaking capacity		6I _e																						
I _{cw}	(KA)	5				10				12.6				50				50						
Converting time (S)		≤3s												≤4s										
Rated controlling capacity (W)	Startup	300				325				355				400				600						
	Natural	55				62				74				98				120						
Operation force (N)		30~50				40~60				65~100				75~120				200~300				250~400		

4. Control characteristics and product structure

4.1 Control characteristics:

There are two types of switch products, three-pole and four-pole (three poles + switchable neutral pole).

Four control types (common type, I, II, III), usually it is common type.

Control characteristics of common type switch:

- a. This switch applies to the automatic change and automatic recovery of main power supply-standby power supply (including manual oil generator; Note: Manual oil generator does not have to be used with type III switches) systems. Power supply I precedes. When power supply I is normal, it is switched on; when power supply I fails and power supply II is normal, the switch changes to power supply II; when power supply I resumes, the switch automatically changes to power supply I.

Control characteristics of type I switch:

- a. This switch applies to the mutual standby of mains supply-mains supply systems. When the switch is in the "0" position, power supply I precedes. When power supply I fails and power supply II is normal, the switch changes to power supply II; when power supply II is on and power supply I resumes, the switch does not automatically change to power supply I, it will change to power supply I only when power supply II fails. The main power supply changes to the standby power supply (the delay continuously adjustable between 1~999s), the standby power supply changes to the main power supply (the delay continuously adjustable between 1~999s).
- b. Phase loss detection protection function, overvoltage, undervoltage protection functions.

4.2 Product structure

Control characteristics of type II switch:

- a. This switch applies to the automatic change and automatic recovery of mains supply-mains supply systems. Power supply I precedes. When power supply I is normal, it is switched on; when power supply I fails and power supply II is normal, the switch changes to power supply II; when power supply I resumes, the switch automatically changes to power supply I. The main power supply changes to the standby power supply (the delay continuously adjustable between 1~999s), the standby power supply changes to the main power supply (the delay continuously adjustable between 1~999s).
- b. Three-phase overvoltage, undervoltage and phase loss detection protection functions.

Control characteristics of type III switch:

- a. This switch applies to the mutual standby or automatic change and automatic recovery of mains supply-oil generator (automatic oil generator with signals) systems. Power supply I (the mains supply) precedes. When power supply I fails, the switch gives a signal to start the oil generator. The oil generator has warm-up delay (continuously adjustable between 0~180s) function. After the oil generator has started, the switch changes to power supply II (the oil generator). When power supply I resumes, the switch automatically changes to power supply I, the oil generator automatically stops after a cooling delay (continuously adjustable between 0~180s).
- b. Three-phase overvoltage and undervoltage protection functions for mains supply and oil generator.

Type I, type II and type III switches have:

- 1) Automatic, remote and manual control functions
- 2) A 0.5s delay of the detection signal, to prevent misoperation.
- 3) A remote control "0" position in automatic state.
- 4) A key switch for the selection of operation mode.

16A-100A/4(Common type)

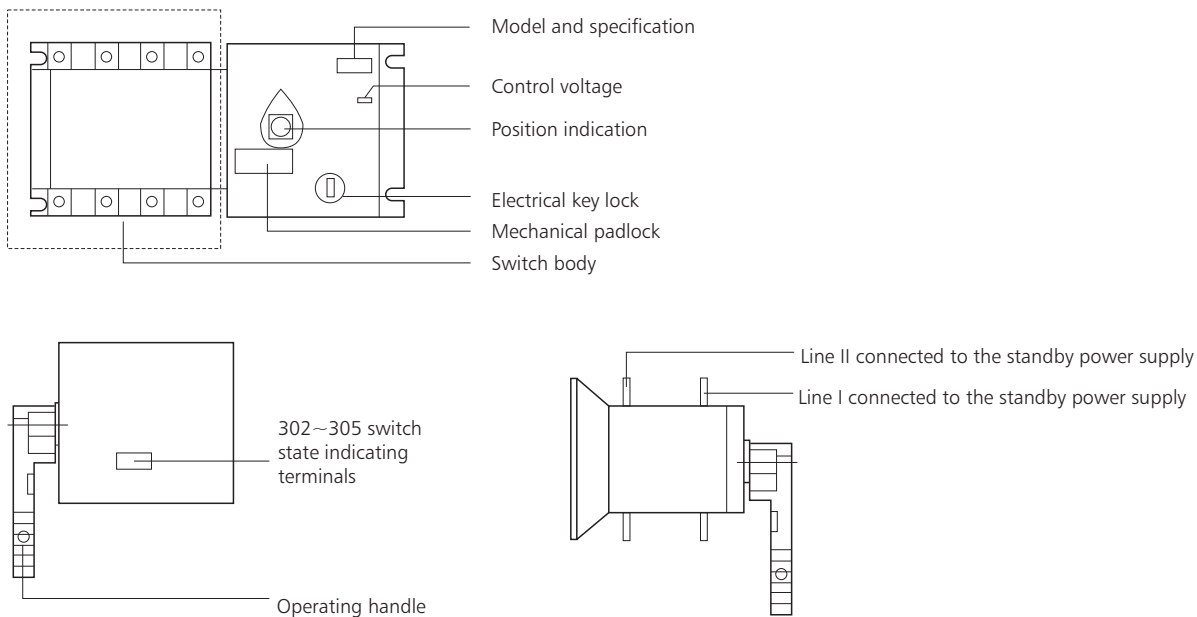

100A/3 common type; 100A/3, 4 type I, type II, type III; 125A-3200A/3, 4 common type, type I, type II, type III

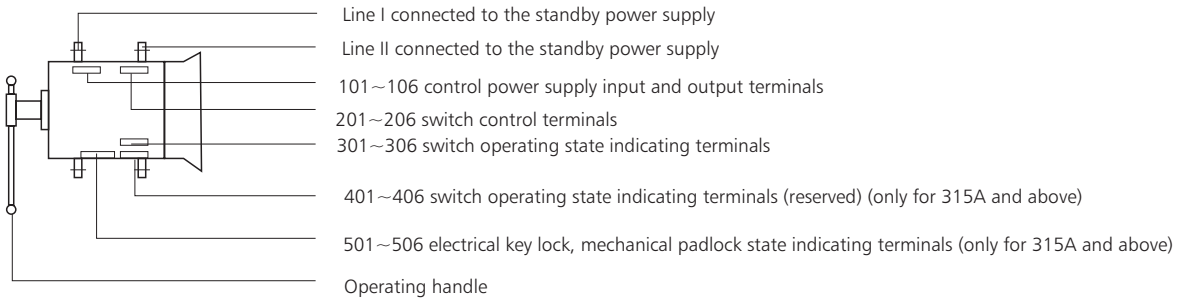
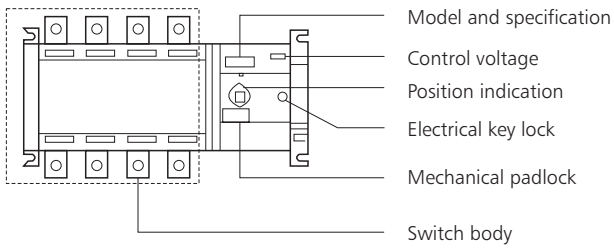

- a. Electrical key lock: It controls the power supply of the internal control circuit of the switch. When the electrical lock is in the "Automatic" position, the switch can be operated automatically or remotely. When the electrical lock is in the "Manual" position, the switch can only be operated manually;
- b. Operating handle: When operating the switch with the operating handle, the electrical lock must be in the "Manual" position;
- c. Mechanical padlock: Before maintenance, put the switch to the 0 position with the operating handle, pull up the padlock structure and lock the padlock. (Pulling up the mechanical padlock switches off the internal control power supply of the switch so that it cannot be operated electrically or manually);
- d. Position indication: It indicates the operating position (I; 0; II) of the switch;
- e. Control voltage: The control voltage class of the switch is 220VAC;
- f. Switch body: The front part is line I, which is connected to the "Normal power supply"; the rear part is line II, which is connected to the "Standby power supply".

4.3 Connection terminal of control circuit

Common type

Connection terminal 1		Connection terminal 2	
Connection terminal 3		Connection terminal 3	
Connection terminal 4		Connection terminal 5	

Type I and type II

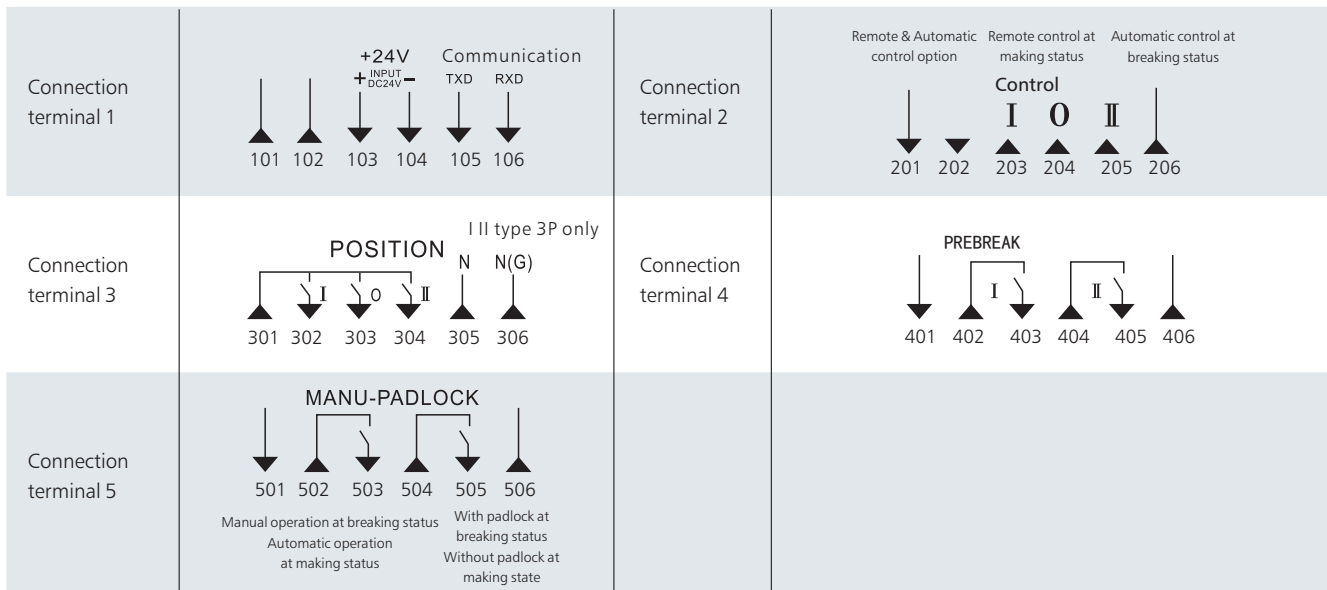

Type III

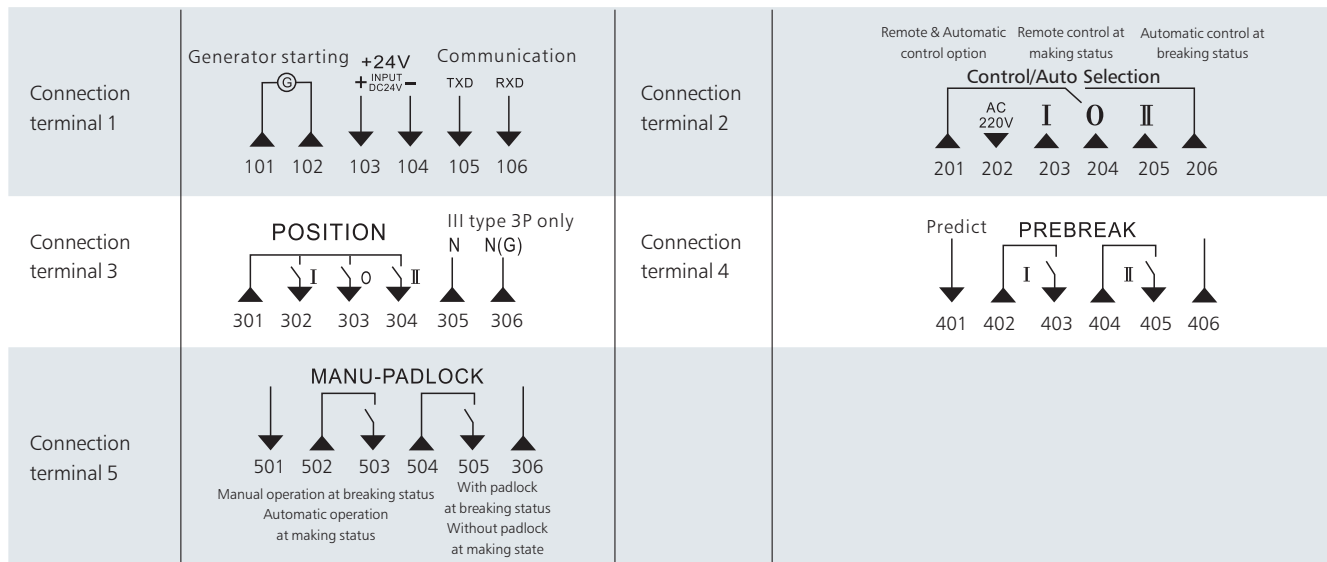

Terminal 1, main options

- 101, 106-Note: They do not connect with other terminal (only for common type)
- 102, 103-Power control terminal of circuit I (only for common type)
- 104, 105-Power control terminal of circuit II (only for common type)
- 101, 102-Generator starting signal input (for type III)
- 103, 104-Firefighting +24V input, enforce "0", both switches breaks (for type I, II, III)
- 105, 106-Communication Interface (Reserved)

Terminal 2, remote control

- 201, 206-Terminal of remote controlling, automatic controlling functions. Remote control at breaking status and automatic control at making status.
- 202, 203-Making switch I.
- 202, 204-At "0" position, both switches breaks (for type I, II, III) (include preferring position "0")
- 202, 205-Making switch II.

Terminal 3, position indication and zero-line terminal

- 301, 302-Switch I position
- 301, 303-At "0" position, all switches breaks
- 301, 304-Switch II position.

- 305-Type I, II, switch I controls zero-line "N1"; type III switch I controls zero-line "N" (only for 3 poles)
- Terminal 4, pre-breaking auxiliary contact
- 306-Type I, II, switch II controls zero-line "N2"; type III, switch II controls zero-line "N(G)"

- 402, 403, Pre-breaking position of indication switch I .
- 404, 405, Pre-breaking position of indication switch II .
- Terminal 5 Manual and automatic operation mode and whether locking the switch
- 502, 503, Automatic and manual control indication
- 504, 505, Indication of whether locking the switch
- Terminal 6 Start-up terminals for diesel generator

501,506: They are superfluity.

5. Connection diagram

5.1 16A~100A 4 poles main switch wiring diagram

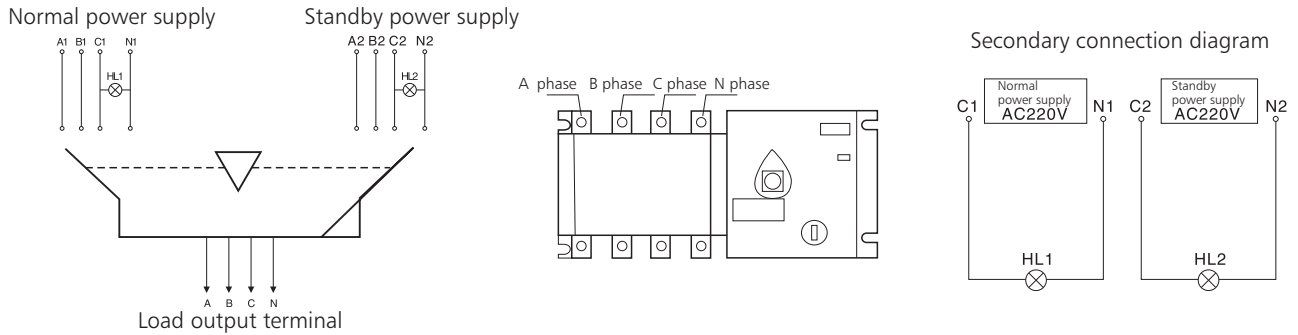

(Special attention should be paid to the sequence of connection.)

Connected to load output terminal

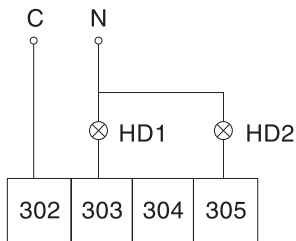

HL1 and HL2 are respectively the resumption indicators of the normal and standby power supplies;
HD1 and HD2 are respectively the service indicators of the normal and standby power supplies;
302~305 are switch terminals.

5.2 125A~3150A main switch wiring diagram

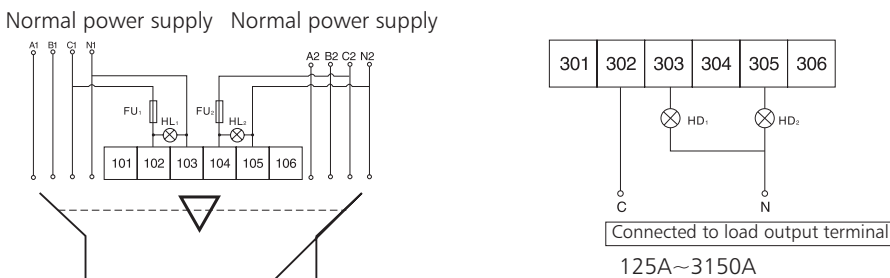

Connected to load output terminal

125A~3150A

Note: Secondary connection of terminal 1 is required (for 16A~100A with forced reset, the connection mode is the same as above).

5.3 125A~3150A Secondary wiring diagram (3P, 4P)

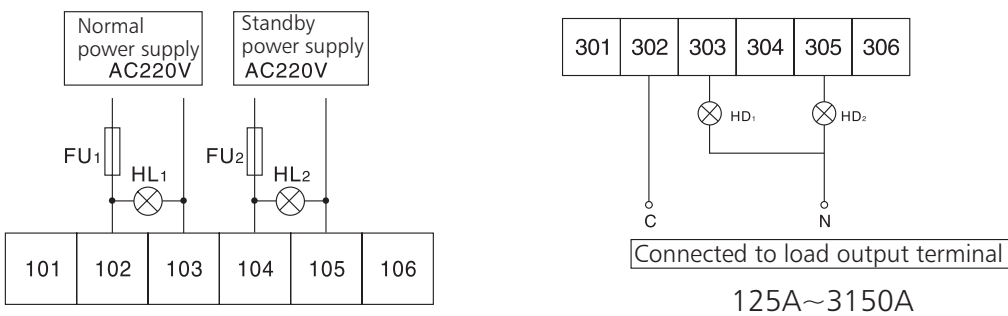

Connected to load output terminal

125A~3150A

HL1 and HL2 are respectively the resumption indicators of the normal and standby power supplies;
HD1 and HD2 are respectively the service indicators of the normal and standby power supplies;
FU1 and FU2 are 5A fuses;
101~106, 201~206, 301~306 are switch terminals.

5.4 Depending on the operating mode, the following connection modes can be used for terminal 2:

a. Fully automatic connection mode

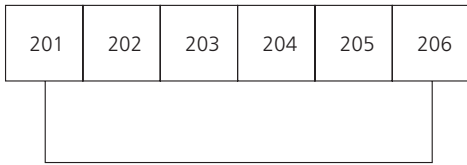

201 and 206 short connected (Normal Type)

Note: Secondary connection of terminal 1 is required.

b. Remote reset (the two power supplies are disconnected) connection mode

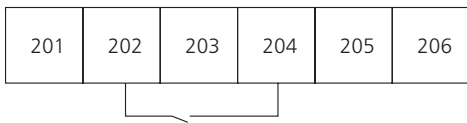

Forced reset contact (passive)

c. Remote connection mode (Note: SB1 and SB2 are external push-button switches)

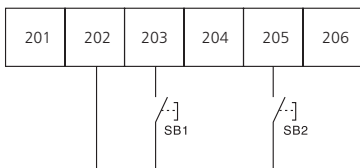

d. Fully automatic + manual (remote) connection mode (Note: SB1 and SB2 are external push-button switches)

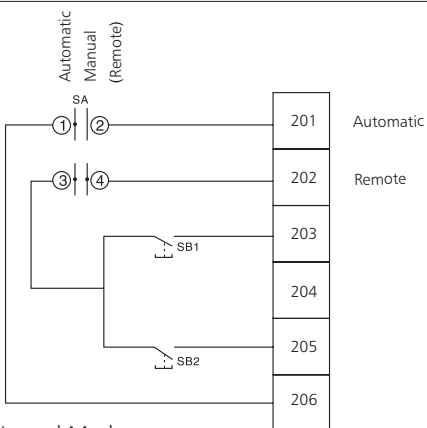

Normal Mode

Note: When switch SA is in the automatic position, ① and ② are connected.

When switch SA is in the manual position, ④ and ③ are connected, but the switch SA must break.

5.5 Connection diagram NH40-16~100

16~100A 3P connection chart

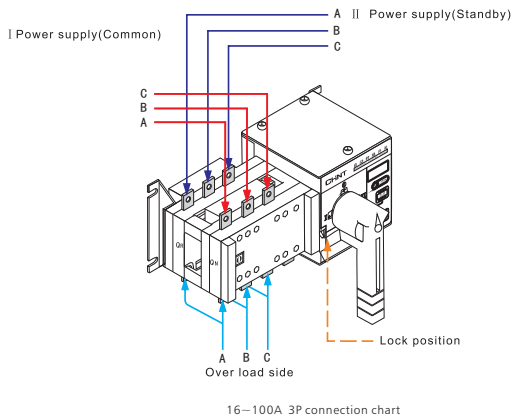

16~100A 4P connection chart

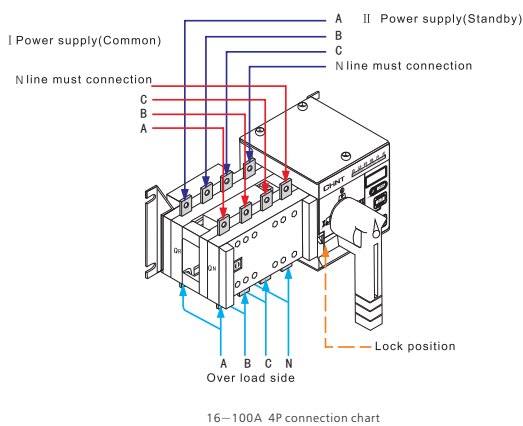

Correct mounting of the switch:

a. Copper busbars I and II are respectively connected to phases R, S, T, N of the normal (front) and standby (rear) power supplies from left to right.

b. The control power supplies are obtained respectively from phases T and N of the normal and standby power supplies.

c. AC220V control power supplies I and II are respectively connected to terminals 102~103 and 104~105, among which 102 and 104 are respectively the live wires of the normal and standby power supplies.

d. Terminals 1.1 and 106 are only used as the control power supplies of the signal lamps. Note: They should not be connected to any other lines.

e. When upper (lower) incoming line is used, phases R, S, T, N of the lower (upper) lines I and II are respectively connected with copper busbars or conductors as the output.

6. Mounting dimension of NH40SZ automatic changeover switch disconnecter

16~1600A

Electric ware controlling connecting area

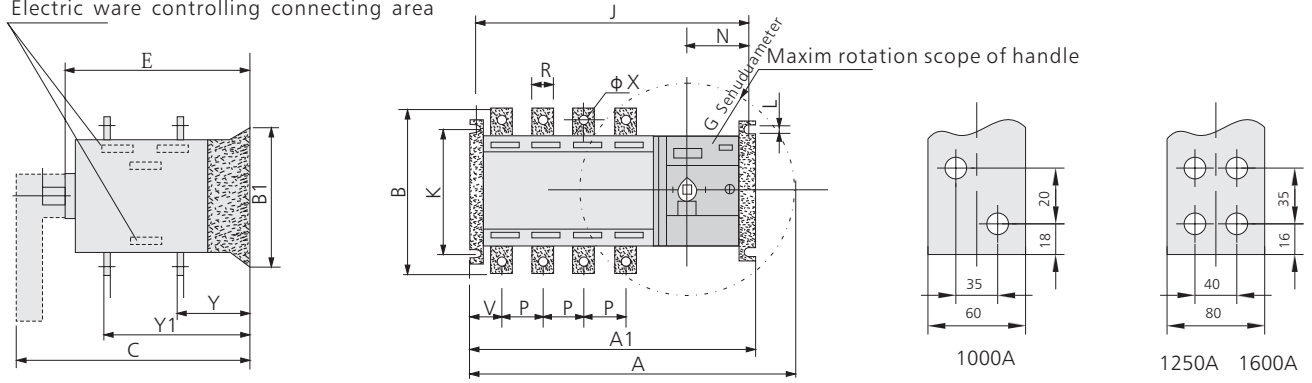

2000~3150A

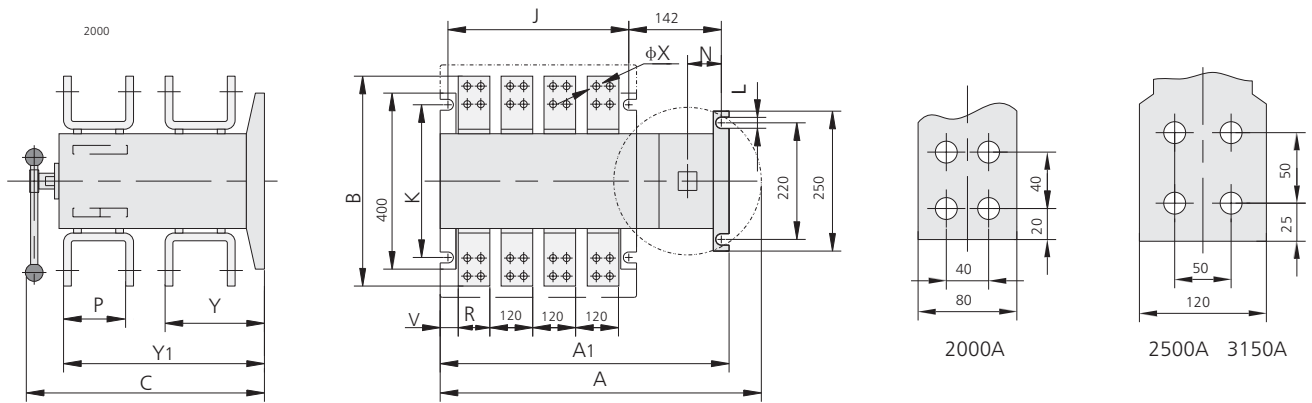

Specification	NH40SZ Mounting dimensions														
	A	A1	B	C	E	J	K	L	N	P	R	V	φX	Y	Y1
16A/3, 4	280	245	106	170	133	234	84	7	75	30	14	20	6	43	93
32A/3, 4	280	245	106	170	133	234	84	7	75	30	14	20	6	43	93
40A/3, 4	280	245	106	170	133	234	84	7	75	30	14	20	6	43	93
63A/3, 4	280	245	106	170	133	234	84	7	75	30	14	20	6	43	93
80A/3, 4	280	245	106	170	133	234	84	7	75	30	14	20	6	43	93
100A/3, 4	280	245	106	170	133	234	84	7	75	30	14	20	6	43	93
125A/3	450	290	135	240	208	275	95/110	7	87	36	20	45	9	58	135
160A/3	450	290	135	240	208	275	95/110	7	87	36	20	45	9	58	135
125A/4	480	320	135	240	208	302	95/110	7	87	36	20	45	9	58	135
160A/4	480	320	135	240	208	302	95/110	7	87	36	20	45	9	58	135
200A/3	460	330	170	240	208	312	95/110	7	87	50	25	45	11	60	140
250A/3	460	330	170	240	208	312	95/110	7	87	50	25	45	11	60	140
200A/4	510	380	170	240	208	358	95/110	7	87	50	25	45	11	60	140
250A/4	510	380	170	240	208	358	95/110	7	87	50	25	45	11	60	140
315A/3	465	375	240	315	270	355	180	11	95	65	32	37.5	11	84	195
400A/3	465	375	240	315	270	355	180	11	95	65	32	37.5	11	84	195
630A/3	465	375	260	315	270	355	180	11	95	65	40	37.5	13	84	195
315A/4	525	435	240	315	270	415	180	11	95	65	32	37.5	11	84	195
400A/4	525	435	240	315	270	415	180	11	95	65	32	37.5	11	84	195
630A/4	525	435	260	315	270	415	180	11	95	65	40	37.5	13	84	195
800A/3	900	530	310	368	320	500	220	11	85	120	60	198	13	108	252
1000A/3	887	515	310	368	320	490	220	13	88	120	60	198	13	108	252
1250A/3	887	515	360	368	320	490	220	13	88	120	70	198	13	108	252
1600A/3	887	515	360	368	320	490	220	13	88	120	80	198	13	108	252
800A/4	1010	640	310	368	320	610	220	11	85	120	60	198	13	108	252
1000A/4	1007	635	310	368	320	610	220	13	88	120	60	198	13	108	252
1250A/4	1007	635	360	368	320	610	220	13	88	120	70	198	13	108	252
1600A/4	1007	635	360	368	320	610	220	13	88	120	80	198	13	108	252
2000A/4	1007	633	455	562	495	467	220	11	85	147	80	33	13	226	457
2500A/4	1007	633	455	562	495	467	220	11	85	152	120	33	13	230	462
3200A/4	1007	633	505	562	495	467	220	11	85	152	120	33	13	230	462
2000A/3	892	518	455	562	495	359	220	11	85	152	120	33	13	230	462
2500A/3	892	518	455	562	495	359	220	11	85	152	120	33	13	230	462
3150A/3	892	518	505	562	495	359	220	11	85	152	120	33	13	230	462